

# RADIO ASTRONOMY

Journal of the Society of Amateur Radio Astronomers  
November - December 2023





**Dr. Richard A. Russel**  
*SARA President and Editor*

**Bogdan Vacaliuc**  
*Contributing Editor*

Radio Astronomy is published bimonthly as the official journal of the Society of Amateur Radio Astronomers. Duplication of uncopyrighted material for educational purposes is permitted but credit shall be given to SARA and to the specific author. Copyrighted materials may not be copied without written permission from the copyright owner.

Radio Astronomy is available for download only by SARA members from the SARA web site and may not be posted anywhere else.

It is the mission of the Society of Amateur Radio Astronomers (SARA) to: Facilitate the flow of information pertinent to the field of Radio Astronomy among our members; Promote members to mentor newcomers to our hobby and share the excitement of radio astronomy with other interested persons and organizations; Promote individual and multi station observing programs; Encourage programs that enhance the technical abilities of our members to monitor cosmic radio signals, as well as to share and analyze such signals; Encourage educational programs within SARA and educational outreach initiatives. Founded in 1981, the Society of Amateur Radio Astronomers, Inc. is a membership supported, non-profit [501(c) (3)], educational and scientific corporation.

Copyright © 2023 by the Society of Amateur Radio Astronomers, Inc. All rights reserved.

Cover Photo:  
Alex Pettit  
Galactic HI

## Contents

<b>President's Page</b> .....	2
Editor's Notes .....	3
<b>SARA 2024 Western Conference</b> .....	4
<b>SARA 2024 Eastern Conference</b> .....	10
<b>SARA NOTES</b> .....	14
Charles Osborne Commentary .....	16
<b>News: (November-December 2023)</b> .....	20
<b>Announcements: (November-December 2023)</b> .....	29
SuperSID .....	32
Announcing Radio JOVE 2.0 .....	35
John Cook's VLF Report .....	41
<b>Featured Articles</b> .....	60
ADALM Pluto as Dual Channel SDR for Interferometry - Wolfgang Herrmann .....	60
Evaluation: <i>4 Small Radio Telescope Systems for Hydrogen Line Acquisition</i> - Alex Pettit ...	67
A Jansky Solar Polarization Radio at 11.7 GHz and 12.2 GHz - Rodney Howe & Paul Oxley.	71
Optimizing Antenna-LNA $T_{SYS}$ Performance by Transmission Line Matching - Peter W East	78
The Auroral Oval and Auroral Zone - Whitham D. Reeve .....	90
Radio Propagation Effects of a Severe Geomagnetic Disturbance - Whitham D. Reeve .....	93
Solar Polar field is going to flip: Beginning of Solar 25 <sup>th</sup> maxima - Santanu Basu.....	96
A water maser flaring event in the W51 star forming region – Eduard Mol .....	99
Mapping the Milky Way by Cross Section – Data/Graphs Interpretation – Felicia Lin.....	108
Fast Radio Bursts (FRBs) – Dave Hinzel .....	119
<b>Observation Reports</b> .....	125
Mapping the galactic arms of the Milky Way in hydrogen - Dr Andrew Martyn Thornett.	125
Unintentional Observations of a HAARP Experiment - Whitham D. Reeve .....	130
AD8302 Interferometer Results – Mike Otte .....	132
Observation Report: Basic Survey of H1 Using Amateur Pyramidal Horn Antenna – Nathaniel Butts .....	141
<b>Journal Archives and Other Promotions</b> .....	146
What is Radio Astronomy?.....	147
<b>Administrative</b> .....	148
Officers, directors, and additional SARA contacts .....	148
<b>Resources</b> .....	149
Great Projects to Get Started in Radio Astronomy .....	149
Radio Astronomy Online Resources.....	151



### Another fantastic year for SARA!

I would like to start with a quote from Wolfgang; "SARA was organized over 40 years ago to provide a resource and forum for amateur radio operators to expand their skills in the design of advanced antennas, receivers, and processing equipment. With advances of technology over time weaker and weaker sources became accessible to amateurs. Observations are possible today which people back in the founding time of SARA could only dream of."

### SARA Accomplishments in 2023

- SARA Grant Committee – Tom Crowley has organized several grants for qualifying organizations
- SARA Store – Lester Veenstra (Store Manager) has done an outstanding job with the Scope-in-a-Box radio telescope program as well as James Pettingale – SuperSID program coordinator, and Dr. Chuck Higgins – Radio Jove Coordinator
- Chip Sufitchi – Outstanding support as the SARA Web administrator
- Special thanks to VP Jay Wilson, Treasurer Brian O'Rourke, Secretary Bruce Randall, Contributing Editors Bogdan Vacaliuc & Whitham Reeve, and Incoming treasurer Tom Jacobs and asst treasurer Donna Hallin, as well as Past President Dennis Farr
- *Jay Wilson and David Westman for their significant efforts in organizing the Eastern and Western conferences this year!*

### Other Accomplishments:

- SARA Journal (Radio Astronomy) – published six times per year
- Fully indexed references to all journals, conference proceedings and video presentations – invaluable for doing research for your radio astronomy project.
- Monthly Zoom session – Drake's Lounge (forum to discuss technical challenges with leading experts)
- Monthly Zoom session – Radio Telescope Observation Party (forum to discuss how to observe astronomical sources)
- Monthly Zoom session – Australia Drake's Lounge (forum to discuss radio astronomy with Australia members)
- SARA – Listserv – real-time forum to provide 24/7 technical interchange between members.
- SARA YouTube Channel – provides presentations on all aspects of amateur radio astronomy. This includes tutorials and radio astronomy observations. <https://www.youtube.com/@radio-astronomy>
- Two major conferences each year (East Coast and West Coast) in which the members meet and present results from the past year.
- 29% Increase in membership and 169% increase in SARA YouTube channel subscriptions
- SARA members wrote the first Radio Astronomy Section of the ARRL Antenna Book 25<sup>th</sup> Edition.

There has been a significant amount of volunteer activity this year! We appreciate everyone's involvement in making SARA a premier international amateur radio astronomy organization.

Thanks! Rich

### Editor's Notes

We are always looking for basic radio astronomy articles, radio astronomy tutorials, theoretical articles, application and construction articles, news pertinent to radio astronomy, profiles and interviews with amateur and professional radio astronomers, book reviews, puzzles (including word challenges, riddles, and crossword puzzles), anecdotes, expository on "bad astronomy," articles on radio astronomy observations, suggestions for reprint of articles from past journals, book reviews and other publications, and announcements of radio astronomy star parties, meetings, and outreach activities.

### Subscribe to the SARA YouTube Channel

SARA has a YouTube channel at: <https://www.youtube.com/@radio-astronomy>

Don't forget to LIKE  the videos! It helps with the YouTube distribution algorithm.

We are also looking to add content to the site. Anyone who wants to help produce a series of 5 - minute videos relating to radio astronomy technology or observations please contact me. ([drrichrussel@netscape.net](mailto:drrichrussel@netscape.net))

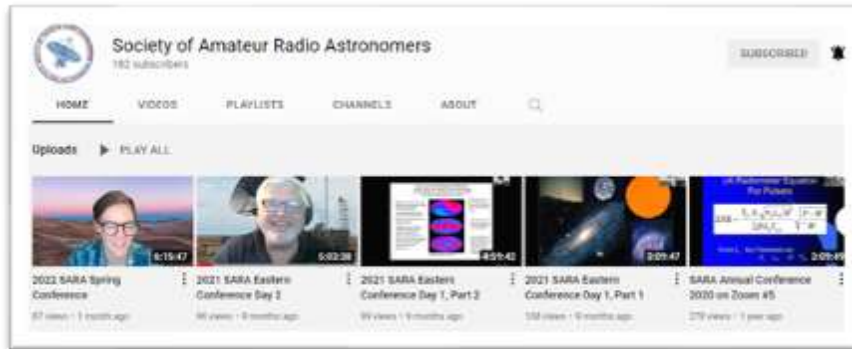

### Observation Reports

We are now accepting 1-2 page observation reports. These reports should include the astronomical object's RA/DEC plus UTC of the observation. Also include the telescope configuration, process used to observe the object and results. Picture of the setup and plots of the observation are a plus to the report.

If you would like to write an article for Radio Astronomy, please follow **the newly updated Author's Guide** on the SARA web site:

[http://www.radio-astronomy.org/publicat/RA-JSARA\\_Author's\\_Guide.pdf](http://www.radio-astronomy.org/publicat/RA-JSARA_Author's_Guide.pdf).

Let us know if you have questions; we are glad to assist authors with their articles and papers and will not hesitate to work with you. You may contact your editors any time via email here: [edit@radio-astronomy.org](mailto:edit@radio-astronomy.org).

The editor(s) will acknowledge that they have received your submission within two days. If they do not reply, assume they did not receive it and please try again.

Please consider submitting your radio astronomy observations for publication: any object, any wavelength. Strip charts, spectrograms, magnetograms, meteor scatter records, space radar records, photographs; examples of radio frequency interference (RFI) are also welcome.

Guidelines for submitting observations may be found here: [http://www.radio-astronomy.org/publicat/RA-JSARA\\_Observation\\_Submission\\_Guide.pdf](http://www.radio-astronomy.org/publicat/RA-JSARA_Observation_Submission_Guide.pdf)

**2024 SARA Western Conference**  
Dallas, Texas, USA on 8 and 9 April 2024

The 2024 SARA Western Conference will be held at Dallas, Texas at the University of Texas campus on Monday and Tuesday, 8 and 9 April 2024. A total solar eclipse will be visible from the Dallas area on the afternoon of April 8, and observation of the eclipse will be a main event of the conference.

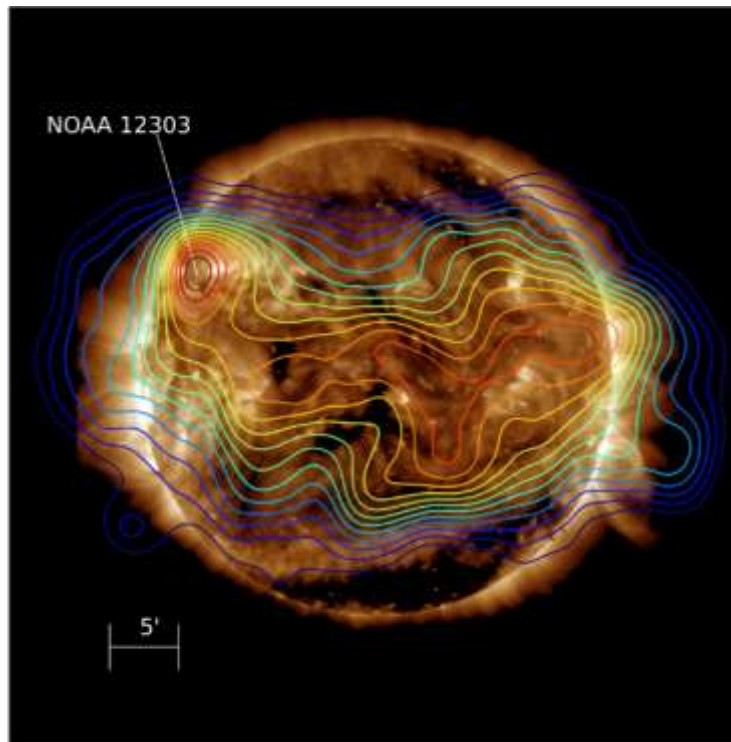

**2015 Solar Eclipse LOFAR contours:** LOFAR contours 50-95% (blue to red) of the peak intensity on top of a Solar Dynamics Observatory/Atmospheric Imaging Assembly 193 Å image. The contours are from a multifrequency LOFAR map (140-160 MHz) and the 193 Å EUV image is from 11:05 UT, during 2015 March 20 partial solar eclipse in Europe, 80% totality.

**Call for papers:** Papers are welcome on subjects directly related to radio astronomy including hardware, software, education and tutorials, research strategies, observations and data collection and philosophy. If you wish to present a paper please email a letter of intent, including a proposed title and abstract to the conference coordinator at [westernconf@radio-astronomy.org](mailto:westernconf@radio-astronomy.org) no later than 1 February 2024.

Be sure to include your full name, affiliation, postal address, and email address, and indicate your willingness to attend the conference either in person or virtually to present your paper. Submitters will receive an email response, typically within one week. Final advance presentations should be submitted

to the Western Conference coordinator for inclusion in the proceedings no later than March 15, 2024. Due to the work required to prepare the proceedings, this should be considered a hard deadline.

**Presentations and proceedings:** In addition to presentations by SARA members, we will have a keynote speech by Dr. Lindsay King of the University of Texas Physics and Astronomy Dept., who will be hosting the conference. They have arranged a National Science Foundation grant to support it.

**Basic schedule:** The conference will be entirely held on the University of Texas Dallas campus. Virtual attendance at the conference using Zoom will be possible at a reduced rate for those who cannot attend in person.

**Contact:** Please contact conference coordinator David Westman if you have any questions or if you would like to help with the conference: [westernconf@radio-astronomy.org](mailto:westernconf@radio-astronomy.org).

**Getting there:** Many major airlines have flights to Dallas/Ft. Worth International Airport.

**Registration:** Registration for in person attendance at the 2024 Western Conference is just US\$75.00. The reduced rate to attend the conference online using Zoom is \$15. You must be a SARA member to register for the conference. The in-person conference rate will include lunch at the conference site on Monday and Tuesday. Payment can be made through PayPal, [www.paypal.com](http://www.paypal.com) by sending payment to [treas@radio-astronomy.org](mailto:treas@radio-astronomy.org). If you need to send a check for registration, please send it to:

SARA Treasurer  
c/o Thomas Jacobs  
P. O. Box 4245  
Wilmington, NC 28406.

Please include in comments that the payment is for the **2024 Western Regional Conference**.

**Hotel reservations:** Further work on hotel reservations is being done at this time. New arrangements will be posted soon (we hope!)

We have received a commitment from the Hilton Richardson Dallas hotel for ten rooms at \$119 +13.52% tax per night, but this rate will probably go away shortly before the conference. So, people who want to use it should contact them right away. Their address and phone are 701 E Campbell Rd, Richardson, TX 75081, Phone: (214) 245-4931. Parking and breakfast are included. If you want to get this rate, send an email to the Western Conference coordinator.

**Monday night dinner:** We will make a group dinner reservation at a local restaurant for Monday night.

**Additional Information:** Additional details will be published online at [www.radio-astronomy.org](http://www.radio-astronomy.org) and in the SARA journal, *Radio Astronomy*, as we get closer to the conference date.

## SARA Western Conference

April 8-9, 2024

Conference Schedule (V = virtual speaker)

Time, CDT [UTC]	Activity/Title	Presenter	Location
<b>Monday, April 8th</b>			
8:00 – 9:00 [13:00]	Registration		
9:00 – 9:15 [14:00]	Introductions, etc.	David Westman, Rich Russel	
9:15 – 10:00 [14:15]	Keynote Speech:	Dr. Lindsay King, UTDallas	
10:00 – 10:45 [15:00]	<i>(Title not yet given)</i>	Wolfgang Herrmann(V)	
10:45 – 11:00 [15:45]	Morning Break		
11:00 – 11:45 [16:00]	Getting started in hydrogen line radio observing using a military dipole array antenna	Andrew M Thornett (V)	
12:00 – 12:45 [17:00]	Lunch		
12:45 – 2:15 [17:45]	Total Solar Eclipse		
2:15 – 4:45 [19:15]	<i>(Unscheduled Talk)</i>		
6:00 – [23:00]	Dinner at restaurant		
<b>Tuesday, April 9th</b>			
8:30 – 9:00 [13:30]	Preparatory activity		
9:00 – 9:45 [14:00]	Total beginners guide to attempting to get started in hydrogen line interferometry using very small dishes < 1m in size	Andrew M Thornett (V)	
9:45 – 10:30 [14:45]	A Novice's Guide to Amateur Radio Astronomy	Nathan Butts (V)	
10:30 – 11:00 [15:30]	Morning Break		
11:00 – 11:45 [16:00]	IBT Eclipse Failure: A presentation of what NOT to do!	Bruce Randall	
11:45 – 12:45 [16:45]	Lunch		
12:45 – 1:30 [17:45]	Mapping the Milky Way by Cross Section Data	Felicia Lin	
1:30 – 2:15 [18:30]	Antennas for Radio Astronomy	Kent Britain, WA5VJB	
2:15 – 2:45 [19:15]	Afternoon Break, Group Picture		
2:45 – 3:30 [19:45]	<i>(Unscheduled Talk)</i>		
3:30 - 4:15 [20:30]	SARA Board Meeting	Rich Russel	

Last update: 13-Dec-2023 DBW

## **SARA Western Conference Abstracts**

### **Getting started in hydrogen line radio observing using a military dipole array antenna.**

Dr Andrew Martyn Thornett. (Virtual)  
British Astronomical Association Radio Astronomy Group

Mapping the arms of Milky Way at 1420.405Mhz and determining the Milky Way's rotation curve has been achieved by many observers with a wide variety of instruments and antennae. The development of readily available, cheap radio equipment, excellent programs for inexperienced observers, and new beginner-friendly software, these observations are easier to achieve than ever before. This paper describes the author's journey and success in this field with the help of the SARA Scope in a Box package, a cheap commercial software defined radio, a repurposed UK military band 3 dipole array < 1m Square, and the ezRA (Easy Radio Astronomy) suite of software, from a radio-noisy urban environment in Staffordshire, England, UK, and how this has encouraged him to take up a wide range of other radio astronomy activities, and to become an advocate for radio astronomy amongst other amateurs without a radio or electronics background.

### **Total beginners guide to attempting to get started in hydrogen line interferometry using very small dishes < 1m in size**

Dr Andrew Martyn Thornett (Virtual)  
British Astronomical Association Radio Astronomy Group

Many newcomers to the amateur radio astronomy have no background in amateur radio, electronics or engineering but do have passion and a desire to expand their horizons beyond observational astronomy and astrophotography. They are keen to explore the same kind of areas covered by professional radio observatories. Current professional observatories use interferometry to achieve larger resolutions that can be achieved with a single dish, and because many amateurs can only access smaller sized equipment, the idea of using similar techniques to achieve larger effective apertures is very enticing.

Radio astronomy forums and groups have members who successfully carry out interferometry experiments using dishes in the 3m range and often complex equipment. My aim was to build and successfully observe interferometry fringes on the Sun using cheap off the shelf components, purchased from every day consumer websites, and dishes < 1m in size, also easily sourced from similar places. As I am hoping that any success that I have with this project can be expanded to hydrogen in the Milky Way, I opted to use 1420MHz. I will describe the ups and downs and then go on to discuss my results, whether I had a degree of success, and lessons I learnt from the experience, and to what extent I think that this can be achieved by other amateurs with limited knowledge and funds.



## A Novice's Guide to Amateur Radio Astronomy

Nathan Butts (Virtual)  
SOKY-RAD

You've fallen down an intellectual or engineering rabbit hole and you're thinking about taking up radio astronomy. Excellent choice! It's fun, it's challenging, it's rewarding, and most of all I've made lots of mistakes that you can learn from to help make your path a little bit easier (hopefully). If you've gotten this far in your own research, you know what radio astronomy is. In this work, we will discuss *why* you would you want to do radio astronomy, *what* to expect on your foray into RA (lessons learned and realistic expectations), its *benefits* over other forms of astronomy, and, importantly, *how* to get started on the right foot. My hope is to encourage incoming novices to be the kind of radio astronomer they want to be and to do the kind of radio astronomy they want to do.

### IBT Eclipse Failure: A presentation of what NOT to do!

Bruce Randall NT4RT (Virtual)

The Itty Bitty Telescope (IBT) is a popular demonstration radio telescope. Plans to use it to show change in 12 GHz solar flux during the partial eclipse of October 14, 2023 did not go as expected. In my area of South Carolina, sun coverage was about 43%, which would show a definite effect on solar flux. I had planned to have a demonstration at a public event at the local science museum.

A shadow device is used to aim the IBT. Final aiming is done with signal strength. A few days before weather was obviously going to be cloudy, so shadow aiming devices will not work. Setting circles were fabricated so that a compass heading would allow aim calibration.

The sun's path was too close to the Clarke belt. The IBT LNB is *designed* to receive satellites.

Paper and presentation are on how to predict problems and hopefully, fix them.

### Mapping the Milky Way by Cross Section Data

Felicia Lin

About 73% of all visible mass in the universe is made of hydrogen. In other words, wherever there is visible mass significant enough to be recorded, it is almost guaranteed to contain an abundant amount of hydrogen. By simply collecting data on hydrogen in our galaxy, we can figure out the shape of our galaxy by some programming and math. The intensity of hydrogen emission tells us the amount of mass, and its velocity computed from the Doppler effect describes its relative distance from the center of the galaxy. To collect data, we maneuver the antenna across the sky to particular regions, and the data is put into a program called ezRA to produce interpretable graphs. To fully understand these graphs, in depth knowledge of how the antenna, program, and the math incorporated is very important. Background

knowledge of Newtonian and electrical physics is necessary for comprehensive conclusions to be drawn on the data collected. At the end of collecting, refining, and interpreting data, we concluded that our findings are similar to what NASA had published of the spiral shape of our galaxy, with spiral arms generally matching up. What is more, we found the galaxy to have a warped shape instead of being completely flat, as with many other studies done by other people.

**2024 SARA Eastern Conference  
and  
Global Radio Astronomy Symposium  
Green Bank Observatory  
Green Bank, West Virginia, 2024  
4-7 August 2024**

The 2024 SARA Eastern Conference and Global Radio Astronomy Symposium will be held at the Green Bank Observatory, West Virginia, Sunday through Wednesday, 4-7 August 2024. The conference will also be available as a fully interactive online event.

With radio astronomy as its foundation, the Green Bank Observatory (GBO) is a world leader in advancing research, innovation, and education.

The first trailblazers of American radio astronomy called Green Bank Observatory home over 60 years ago. Today, their legacy is alive and well. Nestled in the mountain ranges and farmland of West Virginia, within the National Quiet Zone, radio astronomers are listening to the remote whispers of the universe, in order to discover answers to our most astounding astronomical questions.



**Schedule:** Conference meetings will be held in the main auditorium of the Jansky Laboratory at Green Bank Observatory with presentations by SARA members, GBO staff and distinguished speakers. Security and health restrictions permitting, tours of the facility, radio telescopes and laboratories will be conducted. Certain locations are open only to U.S. citizens who submit for a security review two weeks prior; however, most areas will be open to all attendees. ***Fully interactive online participation will be available for those who cannot attend in person.***

Key advantages of in-person attendance are training and hands-on use of the historical 40-foot radio telescope as well as user tutorial and supervised control of the 20 Meter radio telescope.

Sunday through Tuesday evenings, round table discussions and refreshments are scheduled in the Drake's Lounge, and there will be space outside for attendees to set up and display their own portable radio astronomy systems and optical telescopes.

Meals in the GBO cafeteria are included in the registration fee for in-person attendees.

Virtual online sessions are available for those who cannot attend in person.

**Lodging is not included in the conference registration fee.**

A small number of on-site dormitory rooms may become available for conference speakers, support staff and SARA officers. Other conference attendees may request rooms on a standby basis, but it is highly recommended that attendees arrange off-site accommodations.

RV/camping sites and a cabin are available at the nearby Boyer Station Campground. Call 1.304.456.4667 to inquire. The Elk Springs Resort is about 12 miles away. The Snowshoe Mountain area has several lodging facilities.

For other accommodations, please go to <https://www.snowshoemtn.com/plan-your-trip/lodging>. Numerous VRBO / Airbnb properties and private rentals are near GBO.

A list of many properties is at <https://pocahontascountywv.com/lodging/>. Many chain accommodations are located about 30 miles away in Elkins, but that drive takes at least an hour due to mountainous roads.

**Registration:** Registration for in-person attendance by SARA members at the Conference is \$250.00 (USD) if received by July 5, 2024, which includes meals but not lodging. The fee for family members or other guests who do not participate in conference sessions is \$75.00, which includes meals and evening activities. Registration by July 5th for non-members is \$270.00, which includes a year's membership in SARA. SARA members wishing to renew their membership at the same time as they register may also pay \$270 and should include a renewal comment with their payment.

Late registration after July 5, 2024, is \$300.00. Walk-in registration at the conference is \$350.00.

Payment can be made through PayPal, [www.paypal.com](http://www.paypal.com) by sending payment to [treasurer@radio-astronomy.org](mailto:treasurer@radio-astronomy.org) Please include in comments that the payment is for the **2024 Eastern Conference**.

**Online registration will be available at the SARA Store in January 2024:**

**[On-Site Participation](#) or [Online Participation](#)**

---

Proposals for papers, presentations, poster displays and working exhibits are welcome. Initial proposals for papers and presentations should be submitted by May 15, 2024. Abstracts of papers presentation outlines and display details must be submitted by June 1, 2024, with all final materials due on July 5, 2024 to meet publication deadlines. All proposals are subject to peer review and approval.

Presenters who cannot attend in person may be selected for remote video conference presentation. Submit abstracts and proposals to: [jwilson@radio-astronomy.org](mailto:jwilson@radio-astronomy.org) by May 15, 2024.

## **What Green Bank Observatory Visitors Need to Know**

**COVID Restrictions.** GBO reserves the right to impose requirements for vaccinations and masks. SARA will notify all registrants should GBO issue a policy statement. Should GBO policies adversely impact a conference registrant, they may change their registration from in-person to virtual / online and receive a refund for the difference. Should GBO close the campus for any reason, all registrations will be changed to virtual / online.

**No Cellular Phone Service.** GBO is in the National Radio Quiet Zone and there is no wireless phone service in the area. Use of wi-fi devices and satellite phones such as Iridium or Globalstar near the facility is not allowed, and severe restrictions are placed on digital cameras, although film cameras without electronic flash are allowed. There is a computer lab available during the day.

**Pre-Conference Activities.** Suggested pre-conference activities include free self-guided tours of the Green Bank Observatory Science Center and reasonably priced guided tours of the radio telescope area. Full details with a link for ticket purchase: <https://greenbankobservatory.org/visit/>  
An overall guide to other activities and attractions in the area: <https://pocahontascountywv.com/things-to-do/>

**Contact:** Please contact the conference coordinator, B.J. Wilson, if you have any questions or if you would like to help with the conference: [vicepresident@radio-astronomy.org](mailto:vicepresident@radio-astronomy.org)

**Additional Information:** Additional details and updates will be published online at [www.radio-astronomy.org](http://www.radio-astronomy.org) and in the SARA journal, *Radio Astronomy*, as we get closer to the conference date.

## **National Radio Quiet Zone and Major Roads to Green Bank**



# Green Bank Observatory Site Map

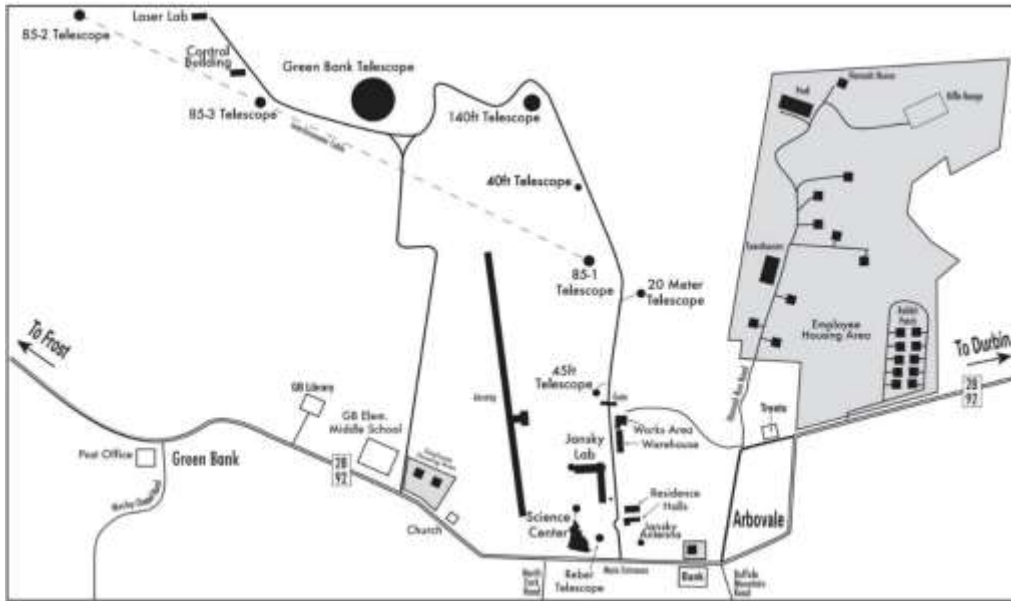

## SARA NOTES

### SARA Student & Teacher Grant Program

All, SARA has a grant program that is, sad to say, very underutilized. We will provide kits or money to students and teachers including college students to help them with a radio telescope project. SARA can supply any of the following kits:

- [1] SuperSID
- [2] Scope in a Box
- [3] IBT (Itty Bitty Telescope)
- [4] Radio Jove kit
- [5] Inspire
- [6] Sky Scan

We can also provide up to five hundred dollars (\$500.00 USD) for an approved radio telescope project.

We have on occasion provided more money based on the merits of the project and the SARA Grant Committee approval.

More information on the grant program can be found at the URL below.

[SARA Student and Teacher Project Grants | Society of Amateur Radio Astronomers \(radio-astronomy.org\)](https://www.radio-astronomy.org/SARA-Student-and-Teacher-Project-Grants)

All that is required is the SARA grant request form be filled out and sent in. If it needs more work for approval, we will work with the students to help ensure their success.

Please pass the word that SARA will fund any legitimate radio telescope project anywhere in the world.

If you have a question, contact me at [crowleytj at hotmail](mailto:crowleytj@hotmail.com) dot com.

Tom Crowley - SARA Grant Program Administrator

### **NEW** Drake's Lounge Australia

This new zoom forum is geared to the Melbourne, Australia time zone (UTC+10) in order to improve coordination with our Australia, New Zealand, and Japanese members. The meetings are scheduled for the 4th Friday of every month, 9 AM Melbourne time (2000 UTC December 23). A zoom announcement will be sent out to all SARA members before the meeting.

### **Radio Telescope Observation Party (RTOP)**

RTOP is designed to demonstrate how to take observations using various radio telescopes. It will also cover how to record and analyze data.

RTOP is every month on the 1<sup>st</sup> Sunday at 2 pm Eastern time (1800 UTC). ZOOM email notifications will be sent to all members.

## **Drake's Lounge**

Join the SARA community as we discuss the latest astronomy and radio astronomy news. The lounge also provides a forum to share and get advice on your radio astronomy projects from very experienced amateur radio astronomers.

Drake's Lounge is every month on the 3<sup>rd</sup> Sunday at 2 pm Eastern time (1800 UTC). ZOOM email notifications will be sent to all members.



## CHARLES OSBORNE COMMENTARY

### ***Burden of Proof***

By Charles Osborne

#### **Abstract**

Every day we are confronted with things we either believe or discount and move on. The how and why those decisions are made forms a less than logical aspect of personality and world view. It spans the areas of faith and training, logic and reason. But like many things today the groups are polarized and more sharply defined than seems reasonable.

The area that brought this in sharp focus for me was the ever-present questions: Are we alone? And why are we here? And the associated UFO/UAP Testimony to Congress.

#### **Intro**

For fifty-five years I've studied various aspects of: history, archeology, science, astronomy, religion, physics, and psychology. I've been entertained by a spectrum of movies from the inane, absurd, and far-fetched minds of non-scientists interpreting and stretching what they think the rules are to sell and popularize topics about life in outer space. Some Directors stick to believable physics and geeks and nerds in the right place allowed to save the day. Other Directors just create a whole genre of superheroes with back stories enabling them to perform the feats of Atlas in modern times, all the while being indestructible so sequels can pull in hundreds of millions of dollars from the public.

Meanwhile for tens of thousands of incidents and millions of people, much more believable accounts in real life, are discounted with terms like:

You must have been mistaken.

That was: Venus, or swamp gas, an equipment malfunction, lens flare, a plane, or a weather balloon.

You must have been dreaming and just remembered it as if it actually happened.

Wasn't there a movie about that?

Have you been drinking?

It's almost as if a whole subculture of misdirection and psyops was stood up to ridicule average people seeing the "wrong thing". Indeed, in the military or for commercial pilots the reports would jeopardize clearances and careers, while subjecting the one reporting to: threats, intimidation, drug tests, and hours of interrogation. Phrases like the following entered popular culture out of real experiences:

This never happened.

You were never here.

Do you wish to file a report?

I watched the recent Congressional testimonies of two pilots and a military intelligence investigator as they recounted their experiences at extreme personal risk, even threats to their lives. And why? With dozens more willing to expand the testimony, if it was not done in a public setting, clearly there is a lot more to hear. Purportedly there are many more whistleblowers coming forward.

## **Categories**

Over time I've come up with the following five categories to describe who and what is behind the scenes driving the discussions or lack there of about alien life UAPs/UFOs across my lifetime.

### **Type One: Fundamentalists**

These are hiding in plain sight everywhere. They are the people whose religious indoctrination was so strong and complete that their world views are challenged, and they simply cannot allow a UFO/UAP reality to be incorporated into their daily life. They marginalize, heckle, demote, fire, or otherwise make their lives difficult for others who espouse the "wrong" beliefs.

On an extreme level these are even the terrorists who looted and destroyed historical sites in Syria, Afghanistan, and Iraq. On a more subtle level they are high ranking military who reroute the careers of people under them into dead end "assignments" where they can "do no harm".

### **Type Two: SETI**

This would seem an odd group to be categorized here. But what I see is a neat boundary drawn around those who search, but really disbelieve ET could already be here. Indeed, that is the reason they vehemently discount the possibility of UFO/UAP. In a way, logic would then dictate, if they can't even hear them from within our own atmosphere, obviously they are on the wrong frequency, the wrong modulation, or the wrong physics entirely. So, to protect their "reason for being" they simply ridicule and demean those who see things. Instead, it backfires and makes the group smaller and more irrational.

### **Type Three: Ancient Aliens**

This is the group who believe many if not all societies were visited and influenced in the distant past by aliens. The belief in this is strong as evidenced by the multiplicity of TV series covering the topic. Whether it's: petroglyphs, rock carvings, cave art, Egyptian cartouches, or the proliferation of thousands of pyramids around the world, the ideas depicted are compelling. The ancient artists show great acumen at depicting horses and animals being hunted. So, who says the odd or unusual figures in the pictures don't actually look like they've been drawn? There are quite likely as many alien species, if not more so, than humans based on what we see in these pictures.

### **Type Four: UFO/UAP**

This brings the ancient aliens discussion to the here and now. In a way most ancient alien believers are very likely to believe in the current sightings as real or want them to be real. But there is quite a spectrum of belief for this category since it is the largest of the categories. Some are willing to entertain that the lights in the sky are just unmanned drones doing reconnaissance. Others say that they are trying to keep us from harming ourselves or the planet. Others take the movie's overwhelming trends toward alien invasion and worry we are being scouted for that. Another faction believes we are in a Zoo and the aliens are the Zookeepers and anthropologists with permission to study us in situ. Some believe we are on galactic quarantine for fear our malevolent nature toward one another might be contagious.

### **Type Five: Men In Black**

This is the scariest of the categories. This is the shadow government group alluded to in the Congressional Testimony. This is the group who will "disappear you" if necessary. They are the ones who for 70 years have operated from black budgets without oversight, amassing sizable assets and hidden facilities containing captured or crashed alien craft and technology. These are the people manning the black helicopters who land and collect all the radar tapes, IR / camera footage, and physical evidence and make it disappear beyond the purview of even Presidents. Their job is to make UAP's harder to prove.

## **Movies as Disinformation**

It's interesting that fear of the public being able to handle the existence of aliens is even brought up as a reason why this stuff is kept secret or discounted. With 70 years of movies and TV series we seem pretty comfortable with the idea ET exists. Is this just a not in my backyard thing?

Purportedly there have been many groups tasked with making UFO/UAP reports disappear, and their authors ridiculed. The list is long. Blue Book being the most obvious. From a friend who knew J. Allen Hynek, I'm told he had pretty much made the full transition from skeptic to believer by the time Blue Book was shut down. I don't know how true to fact the recent Blue Book TV series was. But that's kind of what it is based on.

So, what if the disinformation campaign was contrived to simply "Hide in plain sight"? By that I mean leak enough information of the right types as if they were movie scripts starting in the '50's. With the Moon missions fueling public interest in space and massive funding turning NASA contracts into big business in the '60's. It is quite likely that the hundreds of TV shows and movies using alien-based themes could have been helped along to make the real thing seem like just one's imagination based on a recent show.

Increasing the giggle factor with shows like: Mork and Mindy, Mars Attacks, My Favorite Martian, My Babysitter is an Alien, Paul, Men In Black 1/2/3, and probably dozens of others make it that much harder to have any serious scientific discussion about the topic, as was the intent.

## **Unanswered Questions**

I often watch interviews and am sitting here wondering why no one seems capable of forming useful questions to get whole areas of meaningful discussion started?

Sometimes it's that the people involved just don't have enough Physics and Science background to articulate a complex question. Or that they know the audience will be bored by the whole discussion.

For instance, certain groups use the vast cosmic distances involved to discount that alien life could be here. I don't get that logic at all. Who says they haven't been at this for a long time. Elon Musk wants us to be a space faring race. Who says others are not millions or even billions of years ahead of us?

They may have always been here. Basically, are they aliens if they consider this as their home? There's plenty of places to hide. We've only explored 5% of the oceans. Remote mountain lakes and caves are another source of frequent UFO/UAP reports. The whole Prime Directive and similar noninterference rules espoused in movies makes a good case for not giving us too much rope to hang ourselves.

An interesting thing I learned about radar recently is that low speed objects are gated out of the picture to minimize ground clutter. Things that just hover or wander along don't show up on radar at all for that reason. Most aircraft radar today is highly dependent on transponders. Instead of the weak reflection from a plane, the transponder in the plane answers back with a much stronger coded response giving altitude and plane ID. Anything abruptly accelerating to 3000 mph and 60,000 feet will only be a weak transient artifact that is gone in no time. Remember the radar rotates and only sweeps by every six seconds roughly.

Some Military phased array radars are different. They don't rotate and can be post processed to focus in on targets of interest tracking a large number of items at any one time. Changes in that technology and computer processing power have increased the number and quality of UAP data in the past ten to twenty years. Also, the military planes themselves can share data to build up a nearly 3D world view of where something is around a battle group.

Multispectral imaging also has come a long way. We should be getting data from visual/radar/infrared all at the same time. But then again, the full resolution is often blurred to keep the enemies from knowing the classified capability of the sensors.

If the UAPs have mastered gravity, it means a much smaller specific impulse of thrust can propel a craft to amazing velocities. It still doesn't answer how there is no exhaust, noise, sonic boom, or wake turbulence showing on the radar.

Right angle turns and acceleration rates are among the most interesting to me. That would imply inertia does not affect them. That's why you often hear comments about "if that was us we'd be goo on the wall". Meaning it would be like getting hit by a solid object at 3000 mph. Humans can barely handle 10 G's without blacking out or suffering damage. The G's associated with the motional and accelerations involved is seldom even mentioned as its many orders of magnitude beyond these human limits.

We're often told simply that "That can't be." Meaning it defies the laws of physics as we know them, and that person doesn't want to think about it. Maybe there's a few pages we have not gotten to in those laws. Maybe the UAPs are holograms or trans-dimensional phantoms of things that barely skim our own existence. This does show why the military is so interested in keeping it under wraps.

By pushing some of the artifacts out to military subcontractors, places it outside the Freedom of Information Act. That seems like a clever loophole exploited to pay off the contactor with whatever they can reverse engineer and turn into money. So long as it does not include weaponizable classified technology. My own fear is it puts the information where it can be more easily hacked and stolen.

Another thing that makes you go "Hmmm?" If all this stuff is real, wouldn't it obsolete our present energy sources, Military, and NASA? Yes, no wonder the controllers of information don't want to go there in their belief system. It's definitely the definition of disruptive technology.

### **Summary**

The thought for the day is why is the Burden of Proof so high in the alien life might be here already discussion. Any other theory with so much incidental evidence would at least have a whole subculture pursuing the study. Perhaps it does. It's just that the average person considers watching a TV show or movie as about the extent of their willingness to expend time on delving into such a complex subject. Put a math equation on screen and they change channels out of fear.

In general, one rule I find humans overwhelmingly adopting is "keep things the same". Change may be the only thing that is constant. But it's something we only are comfortable with at a leisurely pace.

**News: (November-December 2023)**



*Helix Nebula ~ X-ray: NASA/CXC; Ultraviolet: NASA/JPL-Caltech/SSC; Optical: NASA/STScI(M. Meixner)/ESA/NRAO(T.A. Rector); Infrared: NASA/JPL-Caltech/K. Su)*

NASA ~ NASA's Chandra Opens Treasure Trove of Cosmic Delights

<https://www.nasa.gov/universe/nasas-chandra-opens-treasure-trove-of-cosmic-delights/>

Michelle Starr ~ Black Holes May Lurk Much Closer to Earth Than We Realized



<https://www.sciencealert.com/black-holes-may-lurk-much-closer-to-earth-than-we-realized>

<https://doi.org/10.1093/mnras/stad1925>

Elisha Sauers ~ Webb finds molecule only made by living things in another world [*Dimethyl Sulfide*]



<https://mashable.com/article/james-webb-space-telescope-exoplanet-discovery-1>

<https://webbtelescope.org/contents/news-releases/2023/news-2023-139?Tag=Exoplanets&page=1>

NASA and the Space Telescope Science Institute (STScI)

Aaron Mok ~ AI chatbots were tasked to run a tech company. They built software in under 7 minutes — for less than \$1

<https://www.businessinsider.com/ai-builds-software-under-7-minutes-less-than-dollar-study-2023-9>

<https://arxiv.org/pdf/2307.07924v3.pdf>

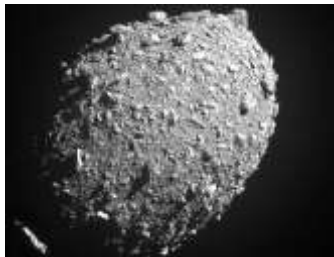

Carlyn Kranking ~ The Asteroid Hit by NASA Seems to Be Moving Strangely, High School Students Find

<https://www.smithsonianmag.com/smart-news/the-asteroid-hit-by-nasa-seems-to-be-moving-strangely-high-school-students-find-180982874/>

<https://arxiv.org/pdf/2308.15488.pdf>

Ethan Siegel ~ Ask Ethan: Why don't neutron stars decay?

<https://bigthink.com/starts-with-a-bang/why-dont-neutron-stars-decay/>



Ethan Siegel ~ JWST discovers the farthest gravitational lens ever

<https://bigthink.com/starts-with-a-bang/jwst-farthest-gravitational-lens/>

NASA ~ NASA's First Asteroid Sample Has Landed, Now Secure in Clean Room

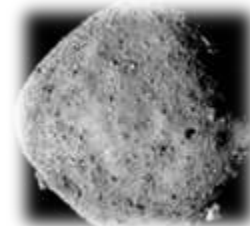

<https://www.nasa.gov/news-release/nasas-first-asteroid-sample-has-landed-now-secure-in-clean-room/>

Abbey A. Donaldson ~ NASA's Benu Asteroid Sample Contains Carbon, Water

<https://www.nasa.gov/news-release/nasas-benu-asteroid-sample-contains-carbon-water/>

William Steigerwald ~ Ten Things to Know About Benu

<https://www.nasa.gov/solar-system/ten-things-to-know-about-benu/>

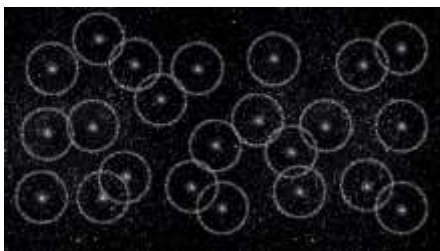

Ethan Siegel ~ Astronomers spot the first "bounce" in our Universe

<https://bigthink.com/starts-with-a-bang/astrophysicists-spot-first-bounce-in-universe/>

<https://iopscience.iop.org/article/10.3847/1538-4357/aceaf3/pdf>

Nancy Atkinson ~ This 3D Simulation of a Supernova Needed 5 Million Hours of Supercomputing

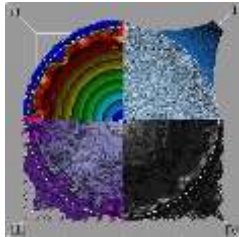

<https://www.universetoday.com/163321/this-3d-simulation-of-a-supernova-needed-5-million-hours-of-supercomputing/>

<https://iopscience.iop.org/article/10.3847/1538-4357/ace968>

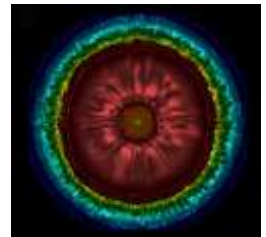

GMTO Corporation ~ The Giant Magellan Telescope's final mirror fabrication begins

<https://phys.org/news/2023-09-giant-magellan-telescope-mirror-fabrication.html>

Matt Growcoat ~ Amateur Astrophotographer Captures Rare Jupiter Explosion

<https://petapixel.com/2023/09/27/amateur-astrophotographer-captures-rare-jupiter-explosion/>





Lucy Hattersley ~ Priority Boarding - get your Raspberry Pi 5 first

Kevin Purdy ~ Raspberry Pi 5, with upgraded everything, available for preorder today

Eben Upton ~ RP1: the silicon controlling Raspberry Pi 5 I/O, designed here at Raspberry Pi



<https://magpi.raspberrypi.com/articles/priorityboarding>

<https://arstechnica.com/gadgets/2023/09/raspberry-pi-5-available-for-preorder-is-faster-and-has-a-custom-i-o-chip/>

<https://www.raspberrypi.com/news/rp1-the-silicon-controlling-raspberry-pi-5-i-o-designed-here-at-raspberrypi/>

<https://datasheets.raspberrypi.com/rp1/rp1-peripherals.pdf>

Michelle Starr ~ Behold, The First Direct Images of The Cosmic Web in The Dark Reaches of The Universe

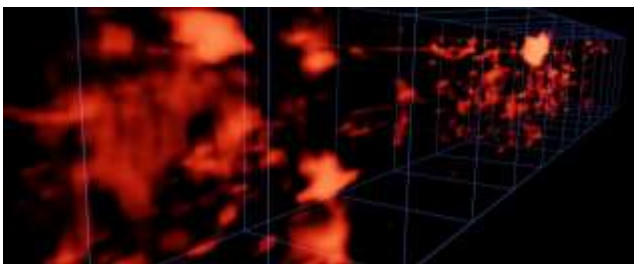

<https://www.sciencealert.com/behold-the-first-direct-images-of-the-cosmic-web-in-the-dark-reaches-of-the-universe>

<https://www.nature.com/articles/s41550-023-02054-1>

Laurence Tognetti ~ Solar Sails Could Reach Mars in Just 26 Days

<https://www.universetoday.com/163333/solar-sails-could-reach-mars-in-just-26-days/>

<https://arxiv.org/abs/2308.16698>



INSTITUTO DE ASTROFÍSICA DE CANARIAS (IAC) ~ Never Before Detected – Organic Molecule Essential for Life Found in Interstellar Space

<https://scitechdaily.com/never-before-detected-organic-molecule-essential-for-life-found-in-interstellar-space/>

<https://doi.org/10.1093/mnras/stad1535>



Matt Williams ~ Magnetic Fusion Plasma Engines Could Carry us Across the Solar System and Into Interstellar Space

<https://www.universetoday.com/163348/magnetic-fusion-plasma-engines-could-carry-us-across-the-solar-system-and-into-interstellar-space/>

<https://arxiv.org/pdf/2309.11524.pdf>



Ethan Siegel ~ JWST finds free-floating planets in the Orion Nebula?

<https://bigthink.com/starts-with-a-bang/jwst-free-floating-planets-orion/>

<https://arxiv.org/abs/2310.01231>

<https://arxiv.org/abs/2310.03552>

Jacob Knutson ~ Scientists use tree rings to find evidence of largest solar storm on record

<https://www.axios.com/2023/10/12/solar-storm-earth-sun-ancient-tree-rings>

<https://royalsocietypublishing.org/doi/10.1098/rsta.2022.0206>

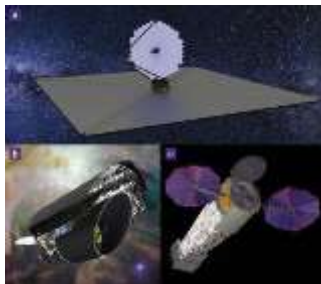

Stephen Clark ~ Astronomers say new telescopes should take advantage of “Starship paradigm”

<https://arstechnica.com/space/2023/10/astronomers-say-new-telescopes-should-take-advantage-of-starship-paradigm/>

<https://doi.org/10.1063/PT.3.5176>

SPIE ~ Miniaturized free-space optical breakthrough unlocks high-speed wireless communication anywhere

<https://techxplore.com/news/2023-10-miniaturized-free-space-optical-breakthrough-high-speed.html>

<https://dx.doi.org/10.1117/1.APN.2.6.065001>



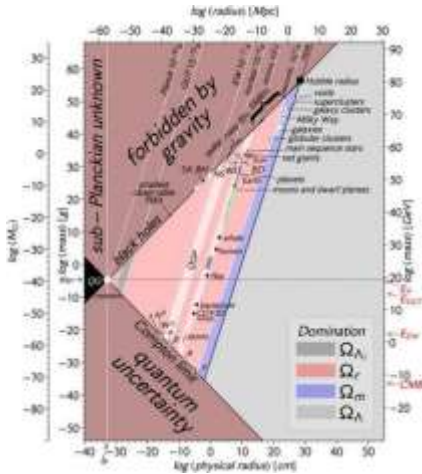

Stephen Luntz ~ The Observable Universe Might Be A Black Hole, Suggests A Chart Of Everything

<https://www.iflscience.com/the-observable-universe-might-be-a-black-hole-suggests-a-chart-of-everything-71203>

<https://www.universetoday.com/163927/everything-in-the-universe-fits-in-this-one-graph-even-the-impossible-stuff/>

<https://doi.org/10.1119/5.0150209>

University of Eastern Finland ~ Accelerating waves shed light on major problems in physics

<https://phys.org/news/2023-10-major-problems-physics.html>

<https://doi.org/10.1364/OPTICA.494630>



Nancy Atkinson ~ Astronomers Release a Cosmic Atlas of 380,000 Galaxies in our Neighborhood

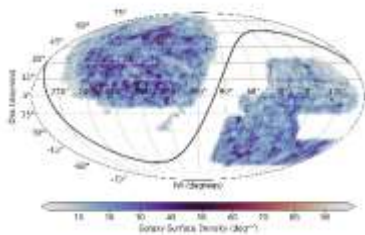

<https://www.universetoday.com/163807/astronomers-release-a-cosmic-atlas-of-380000-galaxies-in-our-neighborhood/>

<https://sga.legacysurvey.org/>

<https://arxiv.org/abs/2307.04888>

Adam Bluestein ~ How the new IMAX movie ‘Deep Sky’ launches you through the James Webb Space Telescope

<https://www.fastcompany.com/90969465/deep-sky-imax-james-webb-space-telescope-director-nathaniel-kahn>

<https://www.imax.com/news/deep-sky>



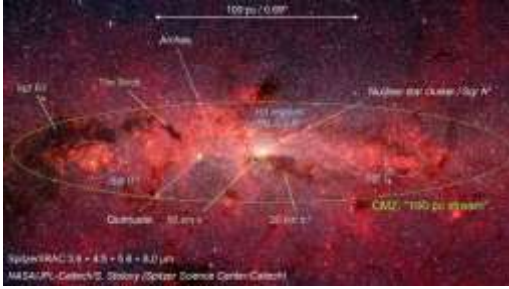

Evan Gough ~ Astronomers Want JWST to Study the Milky Way Core for Hundreds of Hours

<https://www.universetoday.com/163810/astronomers-want-jwst-to-study-the-milky-way-core-for-hundreds-of-hours/>

<https://arxiv.org/abs/2310.11912>

Daniel Patrascu ~ NASA May Have Just Stumbled Upon the Mother of All Space Navigation Solutions

<https://www.autoevolution.com/news/nasa-may-have-just-stumbled-upon-the-mother-of-all-space-navigation-solutions-223795.html>

Goddard Image Analysis and Navigation Tool (GIANT)

<https://software.nasa.gov/software/GSC-18758-1>



Jennifer Willis ~ Ad astra per aspera

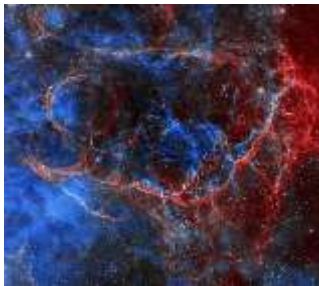

<https://skyandtelescope.org/astronomy-blogs/to-the-stars-through-or-despite-hardship/>

Eric Ralls ~ Saturn's majestic rings will vanish in 18 months

<https://www.earth.com/news/saturns-rings-will-vanish-from-sight-in-2025/>



Let's Take a Walk on the Wild Side ...

David Hambling ~ Controversial Quantum Space Drive In Orbital Test, Others To Follow

<https://www.forbes.com/sites/davidhambling/2023/11/17/controversial-quantum-space-drive-in-orbital-test-others-to-follow>

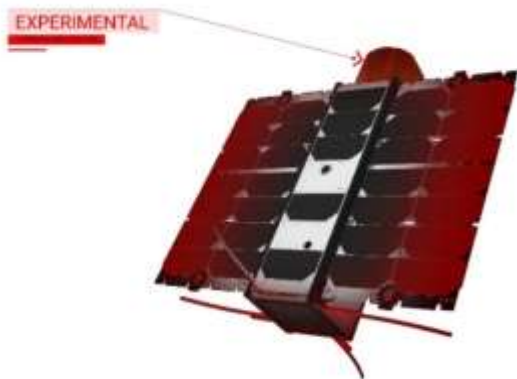

<https://rogue.space/missions/barry-1/>

[https://www.reddit.com/r/IsaacArthur/comments/17xjuly/do\\_we\\_have\\_information\\_on\\_the\\_ivo\\_quantum\\_drive/](https://www.reddit.com/r/IsaacArthur/comments/17xjuly/do_we_have_information_on_the_ivo_quantum_drive/)

Lance Eliot ~ About That Mysterious AI Breakthrough Known As Q\* By OpenAI That Allegedly Attains True AI Or Is On The Path Toward Artificial General Intelligence (AGI)

<https://www.forbes.com/sites/lanceeliot/2023/11/26/about-that-mysterious-ai-breakthrough-known-as-q-by-openai-that-allegedly-attains-true-ai-or-is-on-the-path-toward-artificial-general-intelligence-agi>



Christopher Plain ~ 'First Ever' Experiments to Measure Theoretical 'Quantum Flickering' in an Empty Vacuum Slated for 2024

<https://thedebrief.org/first-ever-experiments-to-measure-theoretical-quantum-flickering-in-an-empty-vacuum-slated-for-2024/>

<https://www.hzdr.de/db/Cms?pNid=99&pOid=70692>

<https://journals.aps.org/prd/abstract/10.1103/PhysRevD.108.076005>

### Technical Knowledge and Education: (November-December 2023)

Larry Niven and Jerry Pournelle ~ The Mote in God's Eye

[https://www.goodreads.com/book/show/100365.The\\_Mote\\_in\\_God\\_s\\_Eye](https://www.goodreads.com/book/show/100365.The_Mote_in_God_s_Eye)

<https://www.amazon.com/Mote-Gods-Eye-Larry-Niven/dp/0671741926>





Royal Museums Greenwich ~ Why do we have special names for full moons?

<https://www.rmg.co.uk/stories/topics/what-are-names-full-moons-throughout-year>

SARA ~ ezRA – Easy Radio Astronomy Analysis Tutorials:

- ⚙ *Simple Overview:* <https://youtu.be/sgid9zn9KkY>
- ⚙ *Analysis 1- Introduction and Data Collectors:* [https://youtu.be/ig\\_jPTuS8ZA](https://youtu.be/ig_jPTuS8ZA)
- ⚙ *Analysis 2- Spreadsheet Analysis:* <https://youtu.be/HkrlN9d6Hd8>
- ⚙ *Analysis 3- Signal Progression:* <https://youtu.be/Vlp7L6glZPY>
- ⚙ *Analysis 4- More Plots and ezb file:* <https://youtu.be/K02MADafOhc>
- ⚙ *Analysis 5- Interference Filters:* <https://youtu.be/FeFk9EvITtc>
- ⚙ *Analysis 6- ezSky:* <https://youtu.be/UNwS0f9X7kE>
- ⚙ *Analysis 7- AntXTVT and VLSR :* <https://youtu.be/0ezig90GNBc>
- ⚙ *Analysis 8- ezGal:* <https://youtu.be/i0St2X7ODKM>

SARA ~ Radio Astronomy Video Series: Constants, Variables and Formulas, Radio Astronomy Formulas:

- ⚙ *Introduction to Radio Astronomy:* <https://youtu.be/AOqvjRXnins>
- ⚙ *Lesson 1- Parabolic Dish Gain:* [https://www.youtube.com/watch?v=2bx5K9jUc\\_w](https://www.youtube.com/watch?v=2bx5K9jUc_w)
- ⚙ *Lesson 2 -Parabolic Dish Half Power Beamwidth:* <https://www.youtube.com/watch?v=XWOMRrwwkl8>
- ⚙ *Lesson 3 -Thermal Noise:* <https://youtu.be/MMJ6Xvapt10>
- ⚙ *Lesson 4 -Focal Length and f/D:* <https://youtu.be/Am6t06KqFPE>
- ⚙ *Lesson 5 -Feed Illumination Angle:* <https://youtu.be/4RZzPzVBSJ4>
- ⚙ *Lesson 6 -Pointing Offset Gain Loss:* <https://youtu.be/dQ8wAaTtm40>
- ⚙ *Lesson 7 -Measuring System Temperature (TSys):* <https://youtu.be/4gVUFFxra-U>
- ⚙ *Lesson 8 -Coax Attenuation Interpolation:* <https://youtu.be/3B8hV6vFyo8>
- ⚙ *Lesson 9 -Pulsar math including electron density, distance, and age:* [https://youtu.be/Bymdp--\\_3JU](https://youtu.be/Bymdp--_3JU)
- ⚙ *Lesson 10 -Distance Math - AU, Parallax, Parsecs and Light Years:* <https://youtu.be/6fo0y3fDOZs>
- ⚙ *Lesson 11 -Doppler Frequency and Relative Velocity Calculations:* <https://youtu.be/8zKloAVpnJc>
- ⚙ *Lesson 12 -Pointing to the Milky Way using a Compass and Protractor:* <https://youtu.be/33xeUSji94U>
- ⚙ *Lesson 13 -Radiometer Equation Basics:* <https://youtu.be/vAyypJ8f2z8>
- ⚙ *Lesson 14 -Noise Figure and Noise Factor Calculations:* <https://youtu.be/GD6wZhW5NPA>
- ⚙ *Lesson 15 -Interpreting Stokes Parameters:* <https://youtu.be/wUVsbfURlsg>
- ⚙ *Lesson 16 -Velocity Factor, Speed of Light in a Coax Cable:* <https://youtu.be/WWuqRyb4Ad8>
- ⚙ *Lesson 17 -Interferometry Fringe Spacing:* <https://youtu.be/rYhUKFn7IWg>

## Announcements: (November-December 2023)

### National Radio Astronomy Observatory ~ Call for Proposals for Semester 24B

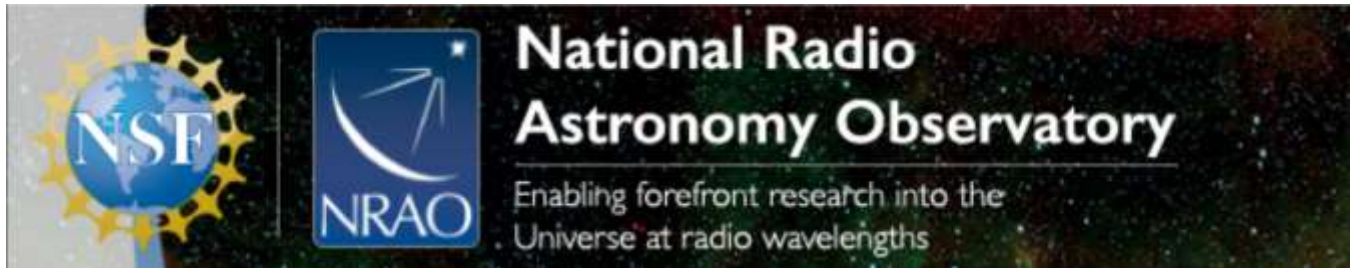

A Call for Proposals (CfPs) with detailed information for Semester 24B will be issued on 3 January 2024 with a deadline for proposal submission on:

Wednesday, 31 January 2024, at 17:00 EST (22:00 UTC).

The CfPs are for the Karl G. Jansky Very Large Array (VLA) and the Very Long Baseline Array (VLBA), High Sensitivity Array (HSA), and Global mm VLBI Array (GMVA). The purpose of this pre-announcement is to highlight aspects of the CfPs to assist with early planning.

#### General Information

Semester 2024B will start around 1 August 2024. For the VLA, the A-configuration will be available. It is anticipated there will be around 1715 hours on the VLA and 800 hours on the VLBA available for science observing, excluding pre-committed time. Opportunities for Joint proposals will be available for ALMA, JWST (see below), HST, Swift, Chandra, XMM-Newton, and NICER. Joint Proposals with ALMA or JWST need to be submitted to the facility requesting a larger amount of observing time.

The array configurations available for joint ALMA/VLA will be ALMA C-1 to C-10 and VLA A, D, and C configurations.

Large Proposals and Proposals that may be considered "high-risk high reward" are strongly encouraged. The B semester also opens the opportunity for Large Proposals to be submitted to the Green Bank Observatory (see below). Finally, proposers are encouraged to submit low-frequency proposals especially in undersubscribed LST ranges. See the relevant observation planning documentation available at:

<https://science.nrao.edu/observing/scheduling>

#### New in Semester 24B

Joint Programs with JWST. Starting in 24B, joint proposals may be submitted requesting time on the James Webb Space Telescope (JWST). A maximum time of 50 hours can be allocated per year on the JWST.

Updated Dissertation Plans. Students that have dissertation plans as part of their NRAO profile will be REQUIRED to update their plans following a strict thesis template. The template is available in either Word or LaTeX formats (see Section 7.2 of the NRAO and GBO Users' Policies).

As stated in the Users' Policies - While not a guarantee, the Observatory allows reviewers to consider elevating the proposal in the rankings if it is associated with an acceptable Plan of Dissertation. This is given in consideration to the time constraints students typically operate under, as having to resubmit a proposal due to minor criticisms may not be possible within the scope of their studies. Therefore, it is advantageous for students to provide a thoughtful and thorough Plan of Dissertation if their PhD research is reliant on the proposal data.

NRAO and GBO Users' Policies. The policies have been substantially updated ahead of the 24B Call for Proposals.

- The requirements and policies concerning Joint Proposals have been significantly revised in Sections 3.2.1 and 3.2.3.
- The policies for VLA and VLBA Resident Shared Risk Observing (RSRO) and Shared Risk Observing (SRO) have been significantly revised in Section 5.2.
- The policy for scheduling General Observing (GO) observations has been updated in Section 5.3.
- The requirements for student Dissertation Plans have been significantly revised in Section 7.2 (see above).

The NRAO and GBO Users' Policies are available online at:

<https://science.nrao.edu/observing/policies/docs/manuals/users-policy/>

#### VLA Spectral Line

Starting with the 24B Call for Proposals, the VLA General Observing Setup Tool (GOST) is obsolete. The NRAO requires the use of a proposing specific version of the Resource Catalog Tool (RCT) for proposers requesting spectral-line or non-default VLA WIDAR resources. For more details and to access the new proposal specific version of the tool, please visit <https://go.nrao.edu/pst-rct>.

#### No High Frequency Large GBT proposals

Less than 100 hours of high frequency (>60 GHz) time is expected to be available for new proposals. The GBT will not accept any large proposals requesting observations at frequencies > 60 GHz (W, Argus, and Mustang2 receivers) for the 24B proposal semester.

#### GBT Infrastructure Work

Infrastructure work is currently planned for the entire months of August and September in 2024. This work will not allow observations to occur. This will impact fixed time and monitoring projects.

Contact: <https://science.nrao.edu/about/contact>

**This is a call for papers for a session on "real-time processing for radio astronomy" for the 4th Atlantic Radio Science Meeting (URSI AT-RASC) in Gran Canaria, Spain, 19-24 May 2024.**

Information on the conference is at: <https://www.atrasc.com/home.php>

We hope you will consider submitting an abstract or paper, and present a talk for Commission J, or a related session at URSI AT-RASC.

Submissions are due 20 January 2024.

**Commission J-07: Real-time Processing for radio astronomy**

Next generation radio telescopes require wider signal processing bandwidths, faster data transport, and shorter processing timeframes while operating on reduced power budgets. To satisfy these demands, fast data interconnects and higher-throughput processing platforms are needed, as well as improvements in algorithmic implementations to make newer instruments a reality. The session for real-time processing for Radio Astronomy (RA) include:

- 1) High performance digital signal processing instrumentation for radio astronomy, e.g. correlators, beamformers, spectrometers, pulsar and FRB machines, and real-time RFI detection and mitigation
- 2) Hardware and software for these digital backends (FPGA, RFSoc, GPU, CPU, SOM, ADC boards)
- 3) Software and hardware for high bandwidth data transport (e.g. transporting data over Ethernet to GPUs)
- 4) Novel algorithms or techniques for real-time signal processing
- 5) Energy efficiency studies and optimization techniques
- 6) Architectures and development tools for all of the above

We hope to see you in Gran Canaria, Spain. Please feel free to distribute this call far and wide to anyone you think may be interested!

Best Wishes,

Session organizing committee

<https://www.atrasc.com/home.php>



SuperSID



**SuperSID**  
*Collaboration of Society  
of Amateur Radio  
Astronomers and  
Stanford Solar Center*



- Stanford provides data hosting, database programming, and maintains the SuperSID website
- Society of Amateur Radio Astronomers (SARA) sells the SuperSID monitors for 48 USD to amateur radio astronomers and the funds are then used to support free distribution to students all over the world (image below as of Fall 2017)
- Jonathan Pettingale at SARA is responsible for building and shipping the SuperSID monitor kits: [SuperSID@radio-astronomy.org](mailto:SuperSID@radio-astronomy.org)
- SuperSID kits may be ordered through the SARA SuperSID webpage: <http://radio-astronomy.org/node/210>
- Questions about the SuperSID project may be directed to Steve Berl at Stanford: [steveberl@gmail.com](mailto:steveberl@gmail.com)
- Jaap Akkerhuis at Stanford is responsible for the SuperSID software and SARA has provided financial support for his efforts
- SuperSID website hosted by Stanford: <http://solar-center.stanford.edu/SID/sidmonitor/>
- SuperSID database: <http://sid.stanford.edu/database-browser/>
- The data is searchable by time, station, date, and multiple plots may be placed on the same graph for comparison.



**SID Monitor  
Distribution**  
1078 instruments  
82 countries  
7 continents

Algeria - 2	Denmark - 3	Mexico - 21	Slovenia - 2
Antarctica - 1	Egypt - 3	Mongolia - 10	South Africa - 8
Australia - 7	Ethiopia - 14	Mozambique - 2	Spain - 1
Austria - 3	France - 9	Namibia - 1	Sri Lanka - 1
Azerbaijan - 2	Gabon - 1	Netherlands - 5	Sweden - 3
Bangladesh - 1	Germany - 30	New Zealand - 7	Switzerland - 4
Bhutan - 1	Ghana - 7	Nigeria - 37	Taiwan - 4
Bhuvia - 1	Ghana - 1	Palau - 1	Tanzania - 3
Bosnia-Herzegovina - 2	Hungary - 1	Peru - 10	Tanzania - 9
Brazil - 11	India - 33	Philippines - 1	Togo - 2
British Virgin Islands - 1	Indonesia - 2	Poland - 2	Uganda - 3
Bulgaria - 2	Iran - 4	Portugal - 3	UK - 32
Burkina Faso - 1	Iraq - 1	Rep of Congo - 3	Uruguay - 8
Canada - 33	Ireland - 9	Romania - 4	US Virgin Islands - 2
Chad - 1	Italy - 42	Russia - 3	USA - 491
China - 18	Kenya - 23	Rwanda - 1	Uzbekistan - 2
Colombia - 9	Korea (South) - 2	S. Africa - 4	Venezuela - 2
Croatia - 7	Lebanon - 11	Senegal - 1	Vietnam - 1
Cyprus - 1	Lithuania - 1	Senegal - 1	Zambia - 2
Czech Republic - 1	Malaysia - 10	Singapore - 3	
D Rep of Congo - 4	Malta - 1	Slovak Republic - 2	

For official use only  
 Monitor assigned: \_\_\_\_\_  
 Site name: \_\_\_\_\_  
 Country: \_\_\_\_\_

## SuperSID Space Weather Monitor Request Form

Your information here	
Name of site/school (if an institution):	
Choose a site name: <b>(3-6 characters) No Spaces</b>	
Primary contact person:	
Email:	
Phone(s):	
Primary Address:	Name School or Business Street Street City <span style="float: right;">State/Province</span> Country <span style="float: right;">Postal Code</span>
Shipping address, if different:	Name School or Business Street Street City <span style="float: right;">State/Province</span> Country <span style="float: right;">Postal Code</span>
Shipping phone number:	<input style="width: 20%; height: 20px;" type="text"/> <input style="width: 20%; height: 20px;" type="text"/> <input style="width: 20%; height: 20px;" type="text"/>
Latitude & longitude of site:	Latitude: _____ Longitude: _____

**I understand that neither Stanford nor the Society of Amateur Radio Astronomers is responsible for accidents or injuries related to monitor use. I will assure that a surge protector and other lightning protection devices are installed if necessary.**

**Signature:** \_\_\_\_\_ **Date:** \_\_\_\_\_

*I will need:*

What	Cost	How many?
SuperSID distribution USB Power	\$48 (assembled)	
USB Sound card 96 kHz sample rate (or provide this yourself)	\$40 (optional)	
Antenna wire (120 meters) (or you can provide this yourself)	\$23 (optional) with connectors attached and tested	
RG 58 Coax Cable (9 meters) (or provide this yourself)	\$14 (optional) with connectors attached and tested	
Shipping	US \$12 Canada & Mexico \$40 all other \$60	
	<b>TOTAL</b>	\$

\_\_\_\_\_ I have included a \$\_\_\_\_\_ check (payable to SARA)

\_\_\_\_\_ I will make payment thru [www.paypal.com](http://www.paypal.com) to [treas@radio-astronomy.org](mailto:treas@radio-astronomy.org)

or

\_\_\_\_\_ If you are a Minority-serving institution, in a Developing or economically deprived nation, and/or you are using the monitor with students for educational purposes, you may qualify for obtaining a monitor at reduced or no cost. Check here if you wish to apply for this designation. Then tell us how you want to use the SuperSID monitor. Include type of site, number of students involved, whether public or private school, grade levels, etc. and describe your program. The goal of the SuperSID project is to provide as many students with systems as possible. If you are able to pay for a system, even if you qualify for a free one, please do so and help support our goal.

---

---

---

---

For more details on the Space Weather Monitor project, see: <http://sid.stanford.edu>

To set up a SuperSID monitor you will need:

<sup>1</sup> Access to power and an antenna location that is relatively free of electric interference (could be indoors or out)

<sup>2</sup> A **PC\*\*** with the following minimal specifications:

- a. A sound card that can record (sample) up to 96 kHz, or a USB port to connect such a sound card (for North and South America)
  - i. All other countries can use AC97 sound card with 48 kHz record (sample) rate. Most computers made after 1997 will have AC97.
- b. Windows 2000 or more recent operating system
- c. 1 GHz Processor with 128 mb RAM
- d. Ethernet connection & internet browser (desirable, but not required)
- e. Standard keyboard, mouse, monitor, etc.

<sup>3</sup> An inexpensive antenna that you build yourself. You'll need about 120 meters (400 feet) of **insulated** wire. Solid wire is easier to wind than stranded. Magnet wire will work but be more fragile. You can use anything from #18 to #26 size wire. The antenna frame can be made of wood, PVC pipe, or similar materials. We'll provide instructions. You can purchase the wire from us or obtain your own.

<sup>4</sup> RG58 coax cable with a BNC connector at one end to run from the antenna to the SuperSID receiver. 9 meters is recommended, but the length will depend on where you place the antenna. You can purchase the coax from us or obtain your own.

<sup>5</sup> Surge protector and other protection against a lightning strike

---

Return this form to: [SuperSID@radio-astronomy.org](mailto:SuperSID@radio-astronomy.org)

or mail to:

SARA Treasurer  
c/o Thomas Jacobs  
P. O. Box 4245  
Wilmington, NC 28406.

## Announcing Radio JOVE 2.0

The Radio JOVE Team



Radio JOVE students and amateur scientists from around the world observe and analyze natural radio emissions of Jupiter, the Sun, and our galaxy using their own easy to construct radio telescopes.

Our Project announces Radio JOVE 2.0, where participants assemble a 16-24 MHz radio spectrograph to observe solar, Jupiter, Galactic, and Earth-based natural radio emissions and share their observations with fellow participants.

### In the Beginning

Radio JOVE started as a NASA sponsored educational outreach project in 1999. We developed a radio telescope kit suitable for receiving signals from Jupiter, the Sun, the Galaxy, and Earth-based radio emissions. The original kit comprised a radio receiver (RJ1.1) and a dual dipole antenna for 20.1 MHz. An important goal was to teach electronic principles including how to build, solder, and assemble the radio receiver and antenna.

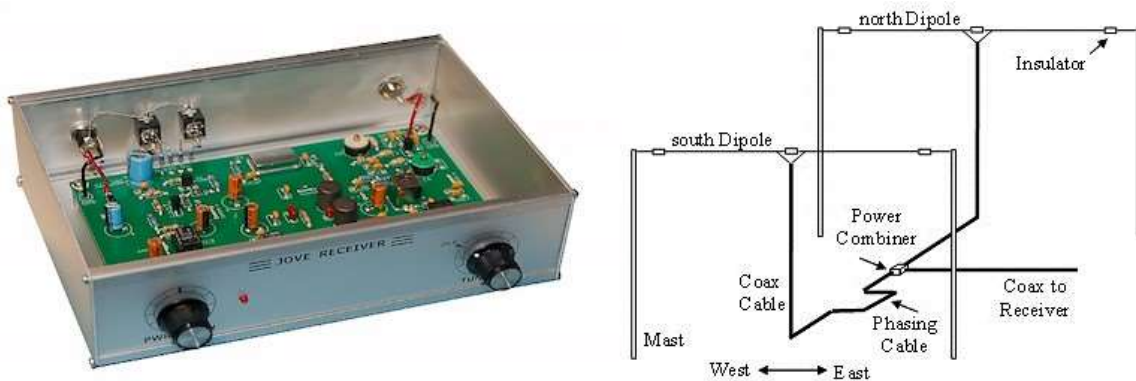

Figure 1. A Radio JOVE RJ1.1 receiver and a schematic of the dual-dipole antenna.

In addition to the hardware, three software packages were developed. These were Radio Jupiter Pro (Jupiter emission prediction program), Radio-SkyPipe (strip chart program) and Radio Sky Spectrograph (control and display of radio spectrograph data).

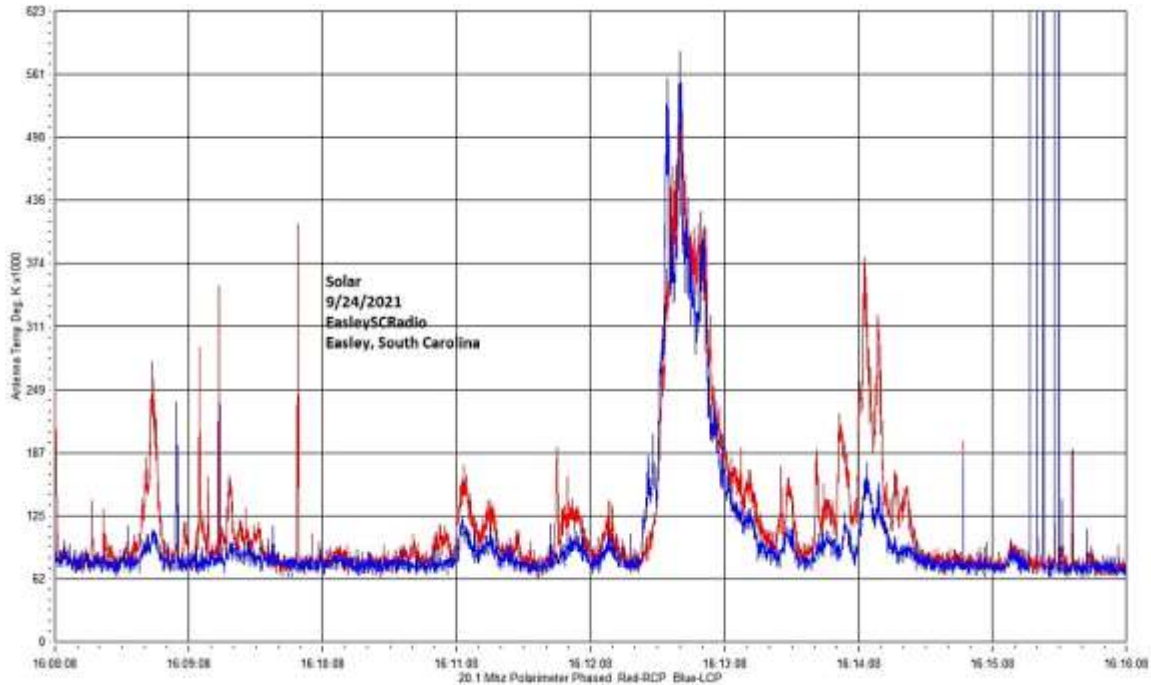

Figure 2. A SkyPipe strip chart showing multiple solar bursts using a JOVE receiver. John Cox, SC.

### The Growth of Radio JOVE

As of Autumn 2021, over 2,500 kits have been sold at cost to schools and individuals around the world. Thousands of data submissions from observers have been made to the Radio JOVE data archive.

The Radio JOVE web site has always provided a wealth of information describing observation methods and various educational materials intended to teach radio astronomy techniques and scientific methods. Biannual newsletters are produced, and several telephone help sessions are held each year.

A sub-group of experienced observers known as the Spectrograph Users Group (SUG) evolved from the core JOVE group. These observers developed data collection and analysis techniques using more advanced equipment and techniques. SUG members have contributed to articles published in peer-reviewed scientific journals. This group remains active under the Radio JOVE listserv at <https://groups.io/g/radio-jove/>.

### Moving Forward with New Technology

In the past, Radio JOVE provided the hands-on experience of building a radio kit. We have many RJ1.1 receivers in operation successfully contributing scientifically valuable data. It has, however, become increasingly difficult to obtain parts for the RJ1.1 receiver kits and we therefore decided to replace the RJ1.1 receiver with a new SDR-based design for the receiver portion of our radio telescope kits. While we continue to support the hardware and software for the original RJ1.1 receivers, the only kits now available for purchase from Radio JOVE contain this newly designed system.

In recent years, new technologies have made software defined radios (SDRs) ever more affordable. These radios can operate on a single frequency like the original JOVE receiver but can also generate spectrograms which depict radio activity as a function of both time and frequency. Such displays offer new insights into our studies of the Sun, Jupiter, the Galaxy, and both natural and artificial Earth-based radio emissions.

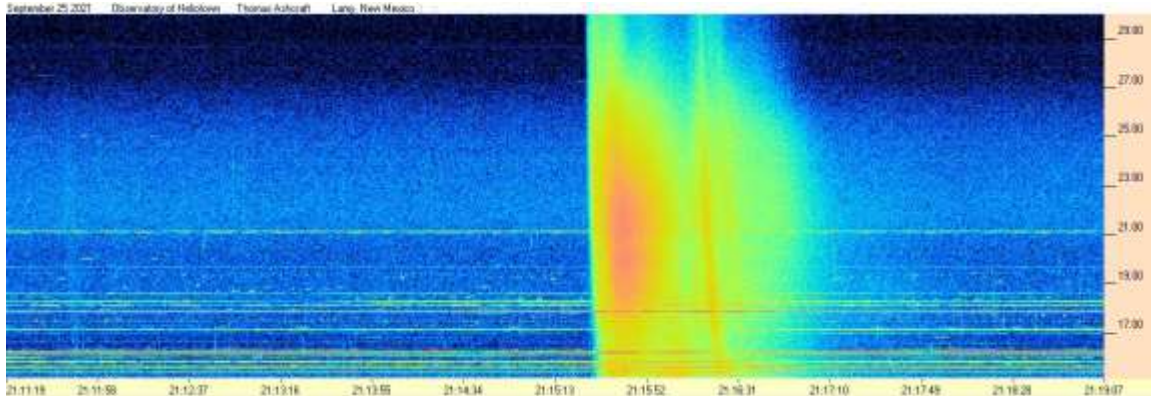

Figure 3. Radio spectrogram showing multiple solar bursts received by Tom Ashcraft in New Mexico. Horizontal scale is time, and the vertical scale is frequency. Amplitude is displayed using different colors corresponding to the strength of signals.

Radio JOVE continues to sell radio telescope packages including an antenna, receiver, and software; however, the receiver is now a commercially built SDR.



Figure 4. The JOVE team has had considerable success with the SDRPlay RSP1A unit and will provide support for using this instrument for our radio astronomy program. Not all SDR types can be supported, but it is our intent to provide support for some other SDRs as they become available during this period of rapid SDR development.

It continues to be our goal to introduce new observers to the scientific method and help them experience the thrill of receiving cosmic radio signals. Through a series of educational training modules and observing and analysis projects we aim to guide new observers to levels where they can contribute to Citizen Science projects.

We continue to support our large user base that uses JOVE RJ1.1 receivers – both in terms of technical support for the receivers but also with new and exciting observing projects for both RJ1.1 and SDR users.

We welcome both new and experienced observers to the JOVE 2.0 program as we share the excitement of receiving, studying, and understanding radio signals from our corner of the galaxy.

Please see the Radio JOVE web site at <https://radiojove.gsfc.nasa.gov> for more information.



## RADIO JOVE 2.0 RADIO TELESCOPE KIT ORDER FORM

Order Online using PayPal™

\* \* \* Please allow 2 to 3 weeks for delivery. \* \* \*

**IMPORTANT:** Before you order the Jove receiver kit and/or the antenna kit, we suggest that you read the on-line manuals. You will need to provide additional materials and tools to complete the antenna. The cost of additional materials for the antenna support structure (masts, etc.) may be in the range of US\$75 to US\$100. Also note that the optimal antenna height can be up to 20ft, depending upon your latitude.

<p><b>Item # RJK2u</b> – Complete 2.0 Kit: Receiver + Unbuilt Antenna Kit + Software</p> <p>This kit includes an SDRplay RSP1A, USB Cable, SMA/BNC cable, F-adapter, unbuilt Antenna Kit (RJA), printed assembly manuals, and Radio-Sky Spectrograph (RSS) software.</p> <p>Note: Kit does not include antenna support structure.</p> <p><b>Price: \$215 + Shipping (See reverse for shipping)</b></p>	<p><b>Item # RJK2p</b> – Complete 2.0 Kit: Receiver + Professionally Built Antenna Kit + Software</p> <p>This kit includes an SDRplay RSP1A, USB Cable, SMA/BNC cable, F-adapter, Professionally Built Antenna Kit (RJA2), printed assembly manuals, and Radio-Sky Spectrograph (RSS) software.</p> <p>Note: Kit does not include antenna support structure.</p> <p><b>Price: \$384 + Shipping (See reverse for shipping)</b></p>
<p><b>Item # RJA</b> – Unbuilt Antenna Kit</p> <p>The RJA Radio JOVE Antenna Kit includes a printed construction manual, stranded copper easy-to-solder antenna wire, ceramic insulators, RG-59 easy-to-solder coax cable, screw-on Fconnectors, and a power combiner.</p> <p>Note: Kit does not include antenna support structure. Assembly requires a soldering gun and other tools.</p> <p><b>Price: \$90 + Shipping (See reverse for shipping)</b></p>	<p><b>Item # RJA2</b> – Professionally Built Antenna Kit</p> <p>The RJA2 Radio JOVE Antenna Kit includes a printed installation manual, two professionally assembled dipole antennas constructed of #14 Copperweld wire with Budwig center insulators and center support rope attachment points, high quality RG-6 coax with pre-installed commercial grade connectors, and a power combiner.</p> <p>Note: Kit does not include antenna support structure.</p> <p><b>Price: \$249 + Shipping (See reverse for shipping)</b></p>
<p><b>Item # LTJ2</b> – Listening to Jupiter, 2nd Ed. by R. S. Flagg</p> <p>PDF download of Richard Flagg's book "Listening to Jupiter, 2nd Ed., 2005". The file is downloaded from a secure website.</p> <p><b>Price: \$10 + \$0 shipping (PDF file download)</b></p>	<p><b>Item # RJR2</b> – Radio JOVE 2.0 Receiver-Only Kit</p> <p>This kit includes one SDRplay RSP1A SDR receiver, USB Cable, SMA/BNC cable, and F-adapter, printed assembly manuals, and Radio-Sky Spectrograph (RSS) software.</p> <p><b>Price: \$135 + Shipping (See reverse for shipping)</b></p>



# RADIO JOVE 2.0 RADIO TELESCOPE KIT ORDER FORM (continued)

Order Online at [https://radiojove.net/kit/order\\_form.html](https://radiojove.net/kit/order_form.html) OR  
 Complete this form and mail with payment

Payment may be made by Credit Card via PayPal™, U.S. Check, U.S. Money Order, International Money Order in U.S. funds drawn on a U.S. bank, or Western Union Money Transfer made payable to **The Radio JOVE Project**. No bank-to-bank wire transfers are accepted. Purchase Orders are accepted from U.S. Institutions.

**Send to:** The Radio JOVE Project  
 1301 East Main St  
 MTSU Box 412  
 Murfreesboro, TN 37132, USA  
 email: [chiggins@mtsu.edu](mailto:chiggins@mtsu.edu)  
 FEIN: 20-5239863

Item	Description	Quantity	Item Price	Shipping (see below)	Subtotal
RJK2u	Complete Radio JOVE 2.0 Kit Receiver + unbuilt Antenna		\$215		
RJK2p	Complete Radio JOVE 2.0 Kit Receiver + Professionally Built Antenna		\$384		
RJA2	Professionally Built Antenna-Only Kit		\$249		
RJA	Unbuilt Antenna-Only Kit		\$90		
RJR2	Receiver-Only Kit		\$135		
LTJ2	Listening to Jupiter, 2 <sup>nd</sup> Ed., by R.S. Flagg (PDF download)		\$10	\$0	
<b>Total:</b>					

**Shipping Fees for Radio JOVE:** We ship all packages using USPS Priority Mail flat rate boxes.  
 U.S.A.: \$17.00  
 Canada: \$57.00  
 All Other International Shipping: \$85.00

**Ship to:** (Please print clearly)

Name: \_\_\_\_\_  
 Address: \_\_\_\_\_  
 City, State, Postal Code: \_\_\_\_\_  
 Province, Country: \_\_\_\_\_  
 Email: \_\_\_\_\_

Visit the Radio JOVE web site and fill out the team application form at [https://radiojove.net/sign\\_up\\_form.php](https://radiojove.net/sign_up_form.php) even if you are just an interested individual so that you can receive important information about kit updates, online services, and activities within the project as they occur!



Please send questions, reports, and observations to John Cook: [jacook@jacook.plus.com](mailto:jacook@jacook.plus.com)

**BAA Radio Astronomy Section**, Director: Paul Hearn

**RADIO SKY NEWS**

**2023 SEPTEMBER**

### VLF SID OBSERVATIONS

Activity in September was a little higher than in August, with 71 C and 17 M-class flares recorded. The GOES data does not show any X-class flares, although some of the M flares were very close. Most of the SIDs that we recorded were less complex than in previous months, and so the total SID count including the unclassified peaks is lower than in August. September also includes the autumn equinox, so our daytime recording period is getting shorter. Roberto Battaïola in Milan had the advantage of monitoring the 20.3kHz from Isola di Tavolara, and recorded this 'well timed' flare peaking at 07:15UT on the 2<sup>nd</sup>:

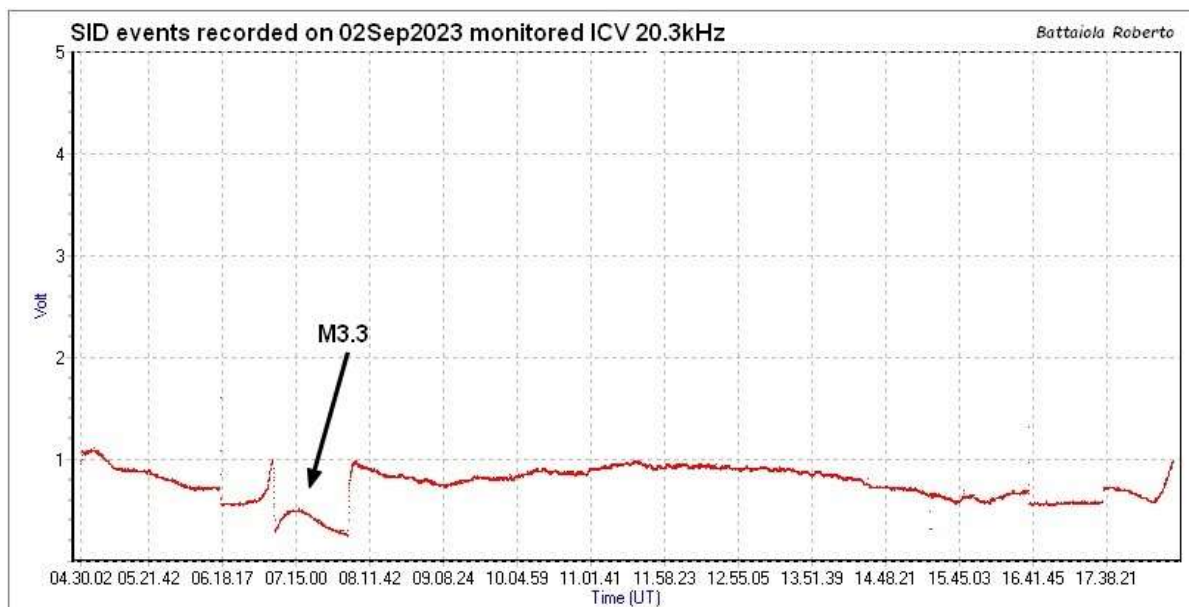

The flare started just before the sudden drop in signal level, but the peak sits neatly near the middle before the signal rises again and the flare fades out. Excellent timing! Isola di Tavolara is a small island near Sardinia, due south of Milan, at 9 degrees east.

The 30<sup>th</sup>. was the busiest day of the month with 12 SIDs recorded. Paul Hyde's recording shows the afternoon's activity on several VLF signals:

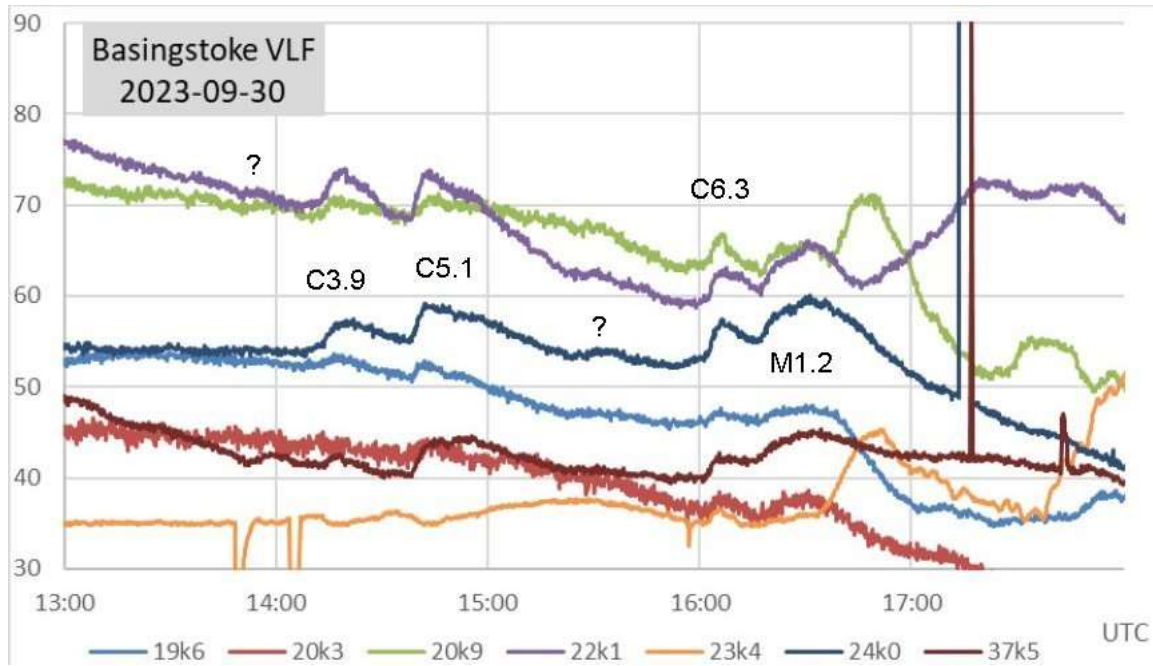

Some of the minor unclassified flares have produced small indistinct SIDs, but not on all the signals. The M1.2 flare has produced a very odd-looking SID at 20.9kHz compared to the smooth response at 24kHz.

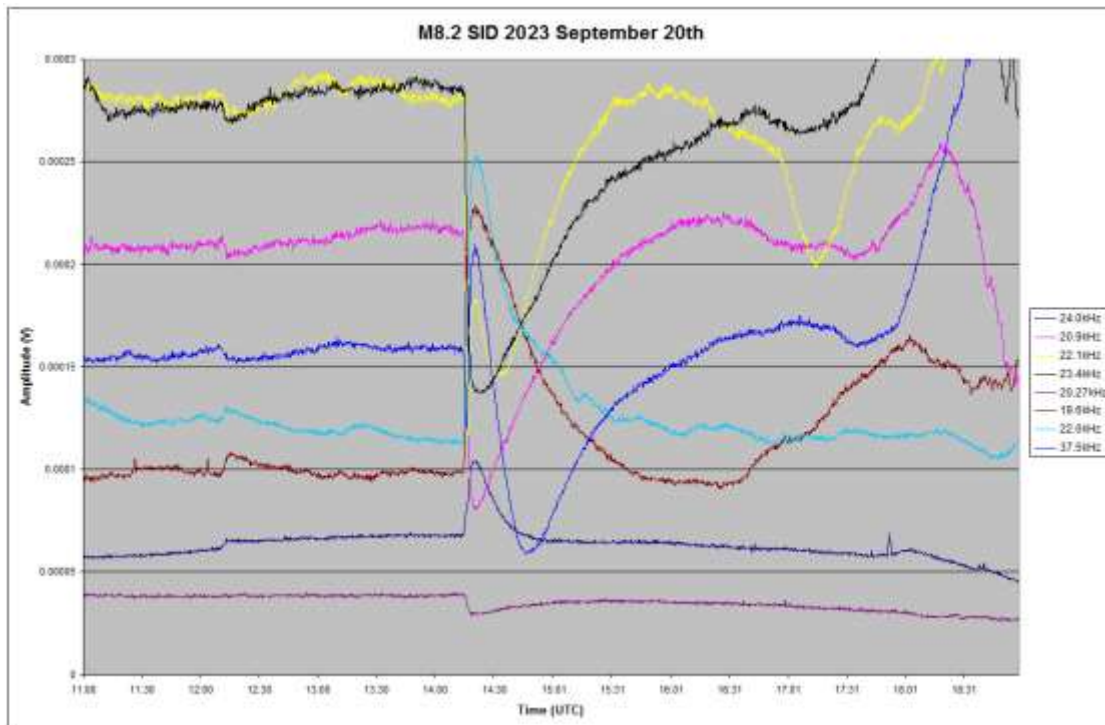

The M8.2 flare peaking at 14:22UT on the 20<sup>th</sup> was one of the strongest and shows a good variety of SID shapes on this recording by Mark Edwards. The chart runs from 11:00 to 19:00, and just shows the much weaker C3.4 flare at 12:13, the C4.2 at 18:04 and C5.5 at 18:40. The last two show best on the Atlantic path at 24kHz, dark blue on the chart.

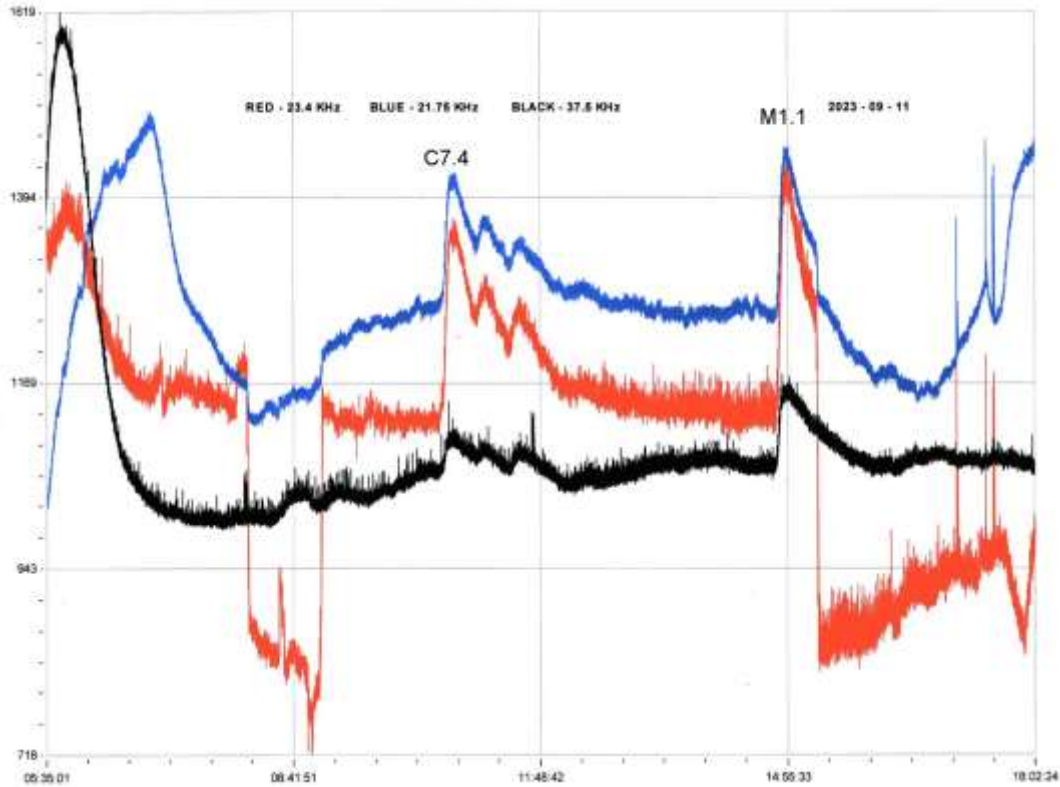

Colin Clements' recording from the 11<sup>th</sup> shows the strong M1.1 flare at 14:50, along with the more complex SID from the C7.4 flare at 10:40. The main peak of this flare was followed by two smaller peaks, unclassified in the GOES data.

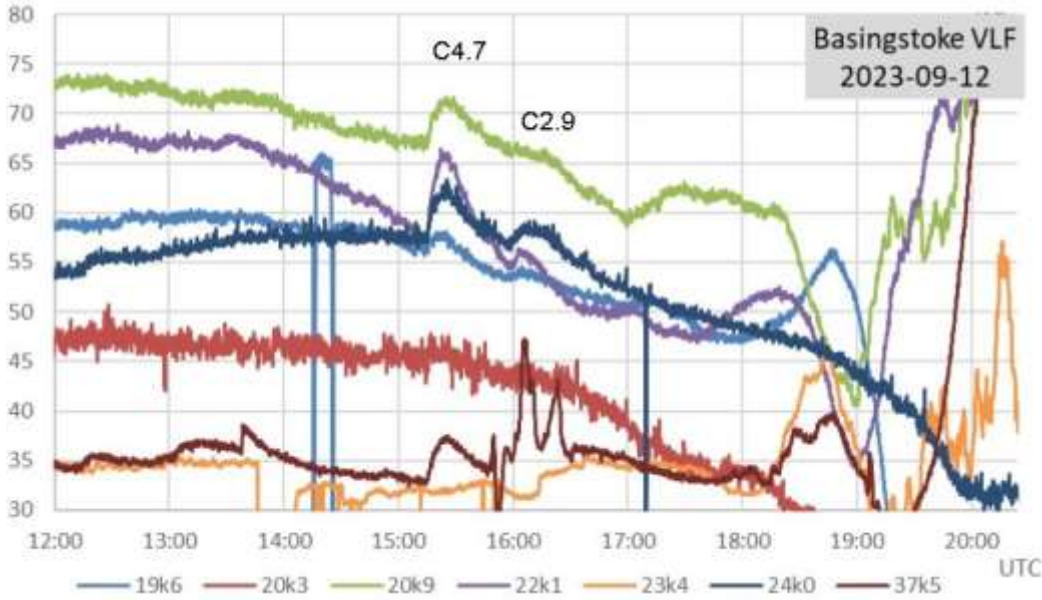

There was more activity on the 12<sup>th</sup>, the afternoon shown in the recording by Paul Hyde. The two SIDs shown were from much weaker flares but are accompanied by a strong disturbance at 37.5kHz linked to a very active magnetic period.

### MAGNETIC OBSERVATIONS.

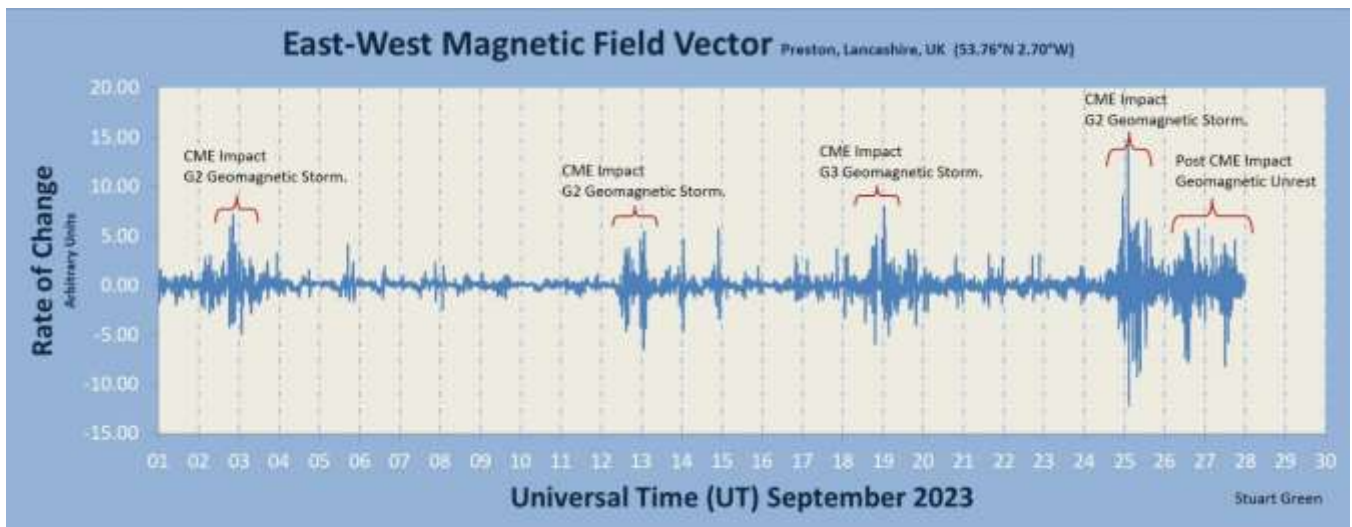

Stuart Green’s monthly summary of magnetic activity shows several periods of disturbance with some quiet periods in between. The 37.5kHz disturbance shown in Paul Hyde’s recording from the 12<sup>th</sup> matches well with the very active magnetic disturbance shown in the charts from Roger Blackwell and Nick Quinn:



Steying Magnetometer (50.8 North, 0.3 West)

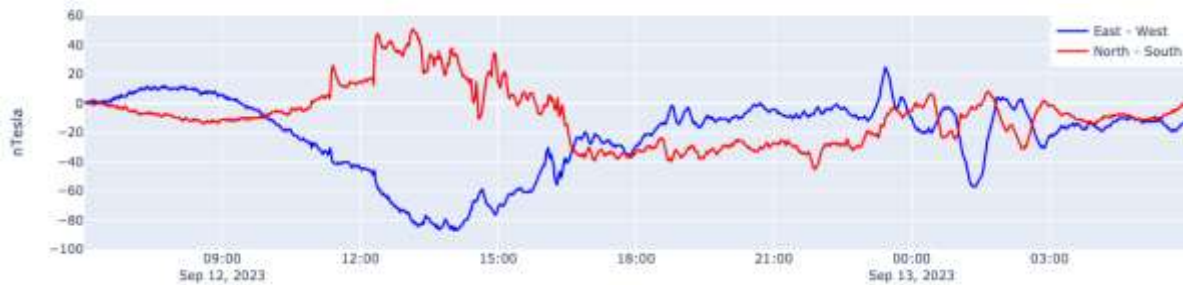

There were numerous CMEs shown in the satellite data, so assigning a specific event to this disturbance is difficult. The STCE bulletin suggests a link to a halo CME from the 7<sup>th</sup>. The sensor midnight reset in Roger Blackwell's recording makes the chart for the 13<sup>th</sup> look more disturbed than the conditions were at the time. The disturbance did continue at a lower level through the next few days until the arrival of another CME on the 18<sup>th</sup>. All our recordings show a sudden impact at about 13:30, with a strong disturbance for the rest of the day.

Wobister Magnetometer (59.17N, 3.06W)

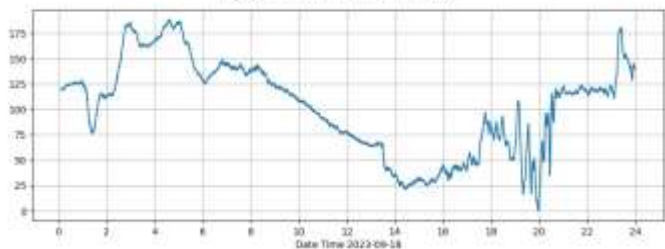

Wobister Magnetometer (59.17N, 3.06W)

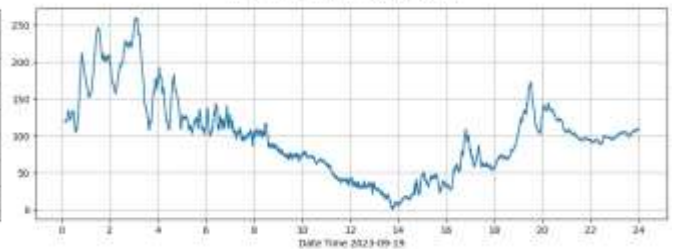

Callum Potter's recording shows the sudden impact, followed about four hours later by some rapid turbulence in the magnetic field. The chart for the 19<sup>th</sup> covers a larger magnetic range up to 250nT, while the chart for the 18<sup>th</sup> is 175nT. The STCE bulletin links this to a large filament eruption on the 16<sup>th</sup>.

Steyning Magnetometer (50.8 North, 0.3 West)

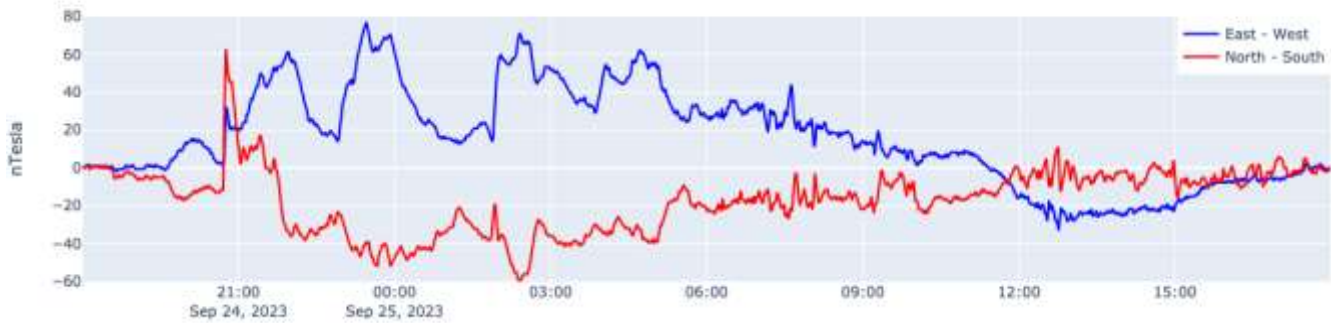

The summary chart shows strong magnetic activity from the 24<sup>th</sup> through to the end of the month. Nick Quinn’s recording for the 24<sup>th</sup>/25<sup>th</sup> shows another strong impact feature at about 20:45, followed by some large but slow disturbance through the early morning of the 25<sup>th</sup>. The turbulence then decreases in amplitude but increases rapidly in speed. Roger Blackwell’s chart for the 25<sup>th</sup> shows this well:

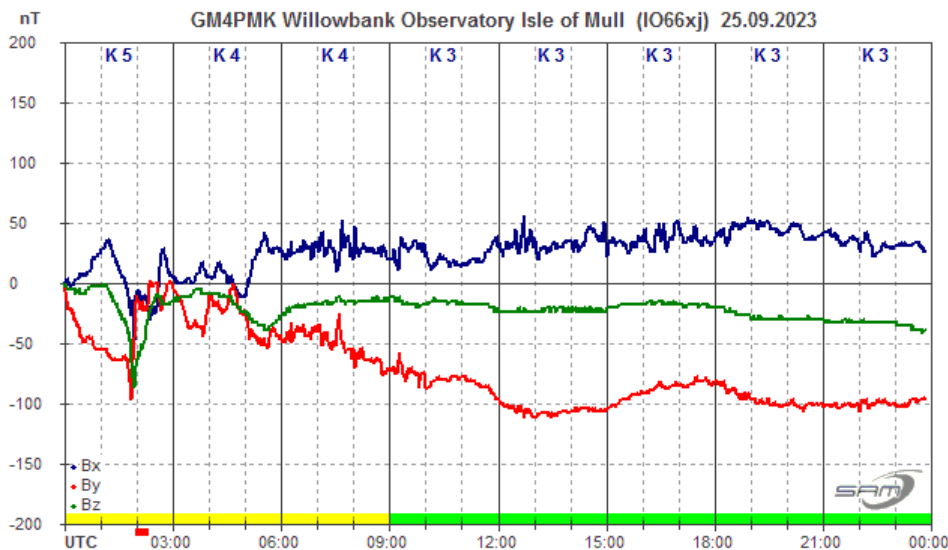

The source of the activity seems to be a combination of multiple CME’s and a coronal hole high speed wind. The disturbance continued right through to the end of the month, fading slowly. Callum Potter also reported that the activity on the 12<sup>th</sup> / 13<sup>th</sup> also produced some excellent aurora visible in Orkney.

Magnetic observations received from Roger Blackwell, Stuart Green, Callum Potter, Nick Quinn, and John Cook.

### SOLAR EMISSIONS.

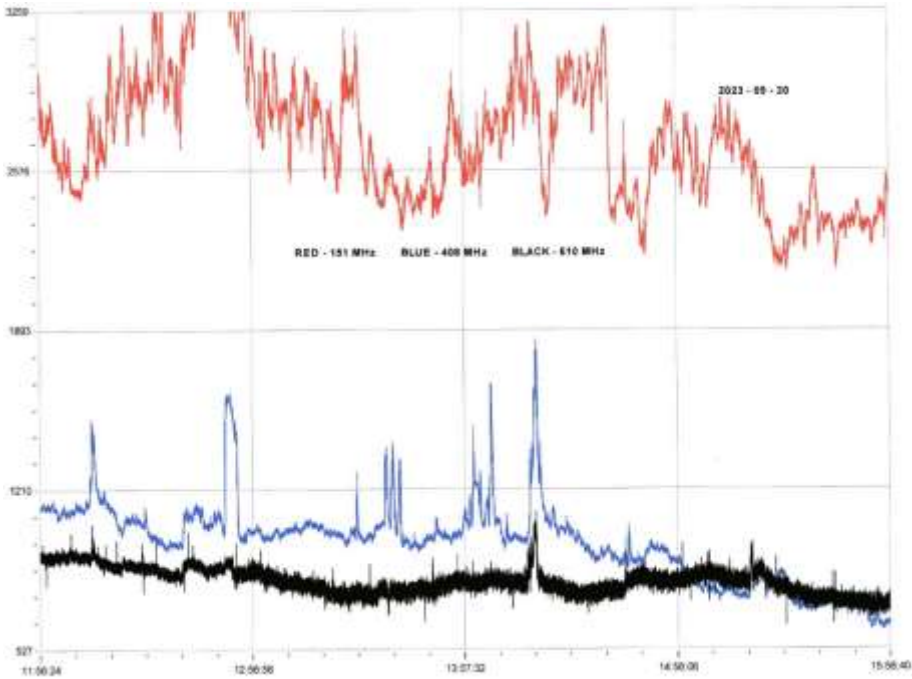

Colin Cements' recording from the 20<sup>th</sup> shows some significant noise, particularly at 151MHz (red) through the afternoon. The M8.2 flare at 14:20UT matches with the strong 408MHz (blue) spike, along with a much weaker spike at 610MHz (black).

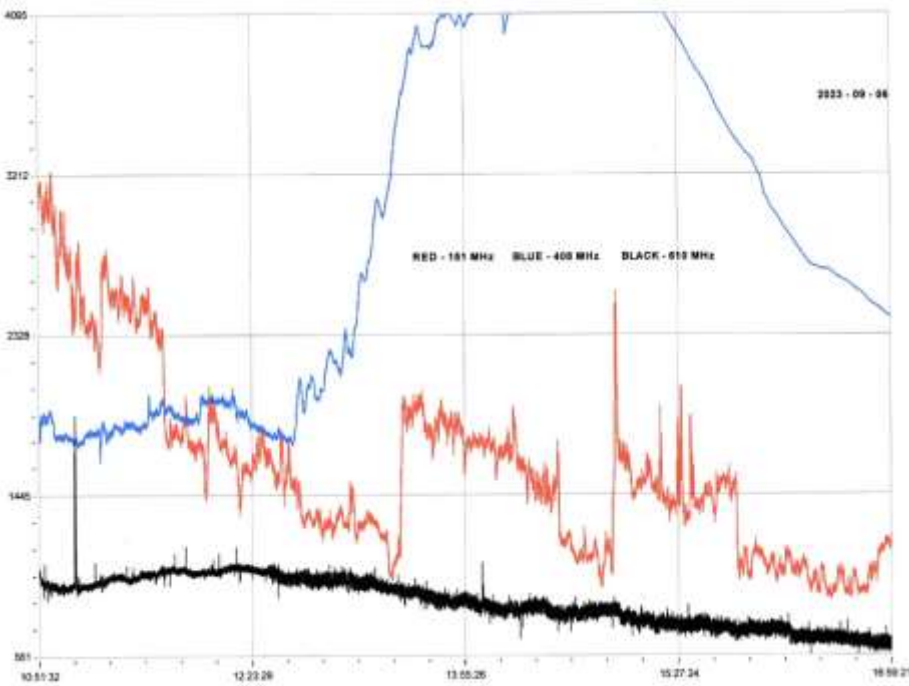



The recording from the 6<sup>th</sup> is more of a puzzle, with a very strong 408MHz signal over the entire afternoon. There was a series of C-flares in the afternoon, but unlikely to be responsible for this signal. With the sun now much lower in the sky, Colin's outdoor aerials will lose their view of the sun over the next month.

**MUONS.**

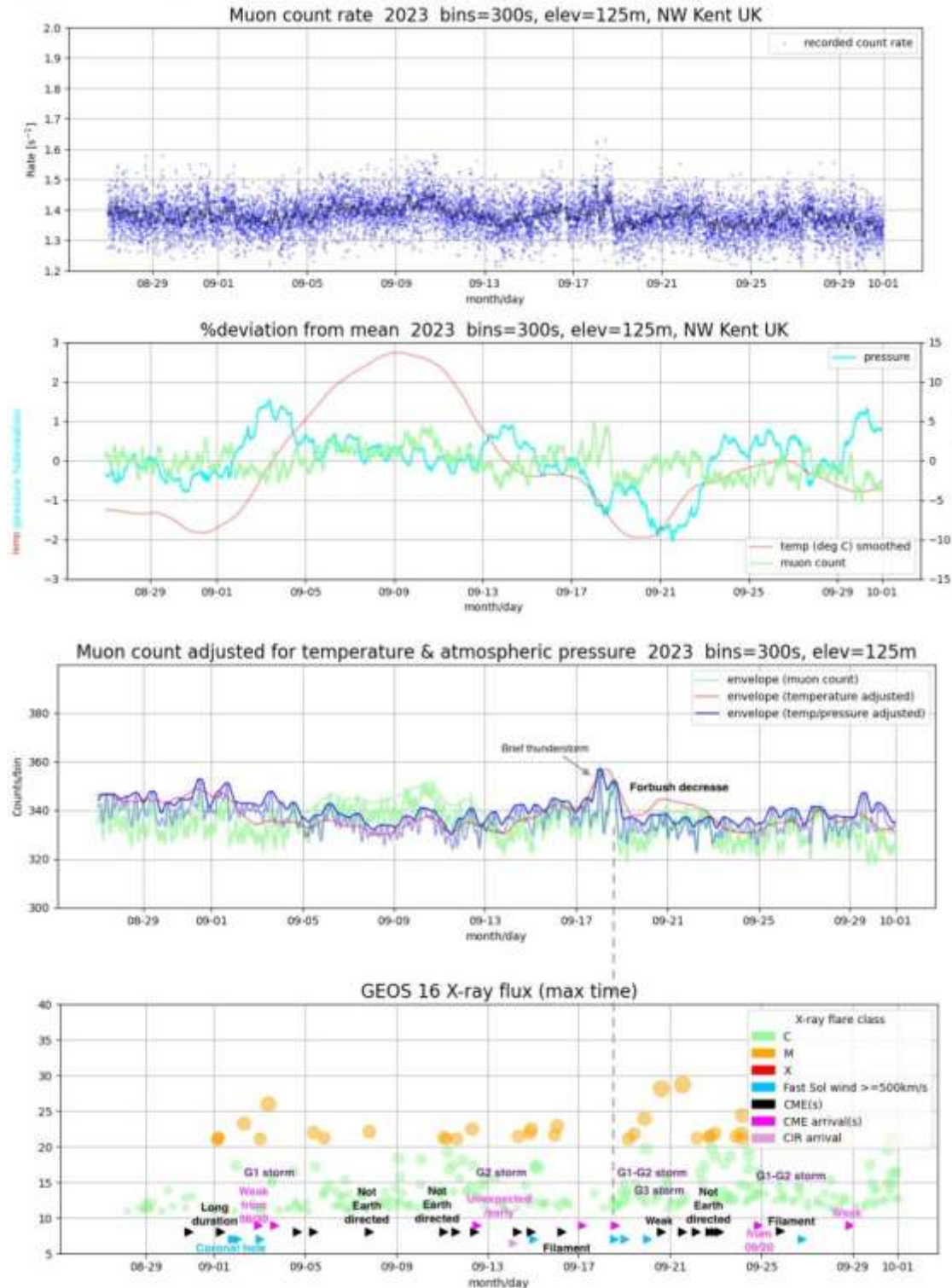

Mark Prescott's Muon recordings show another strong Forbush decrease on the 18<sup>th</sup>, following the large CME impact seen in our magnetic observations. It is slightly camouflaged by a local thunderstorm overnight on the 17<sup>th</sup>, but the adjusted average does show it. There were also Forbush decreases on the 13<sup>th</sup> and 15<sup>th</sup> but were not clear in Mark's data.

VLF SID OBSERVATIONS.

Solar flare activity in October was much lower than last month, only about ¼ of the level recorded at the peak in May. This may be an indication of a double peaked solar cycle, similar perhaps to the previous cycle. Predictions still show a peak expected in 2024 or 2025. It is also worth noting that there were some stronger flares during our nighttime, slightly biasing our statistics. This should even out over the longer term.

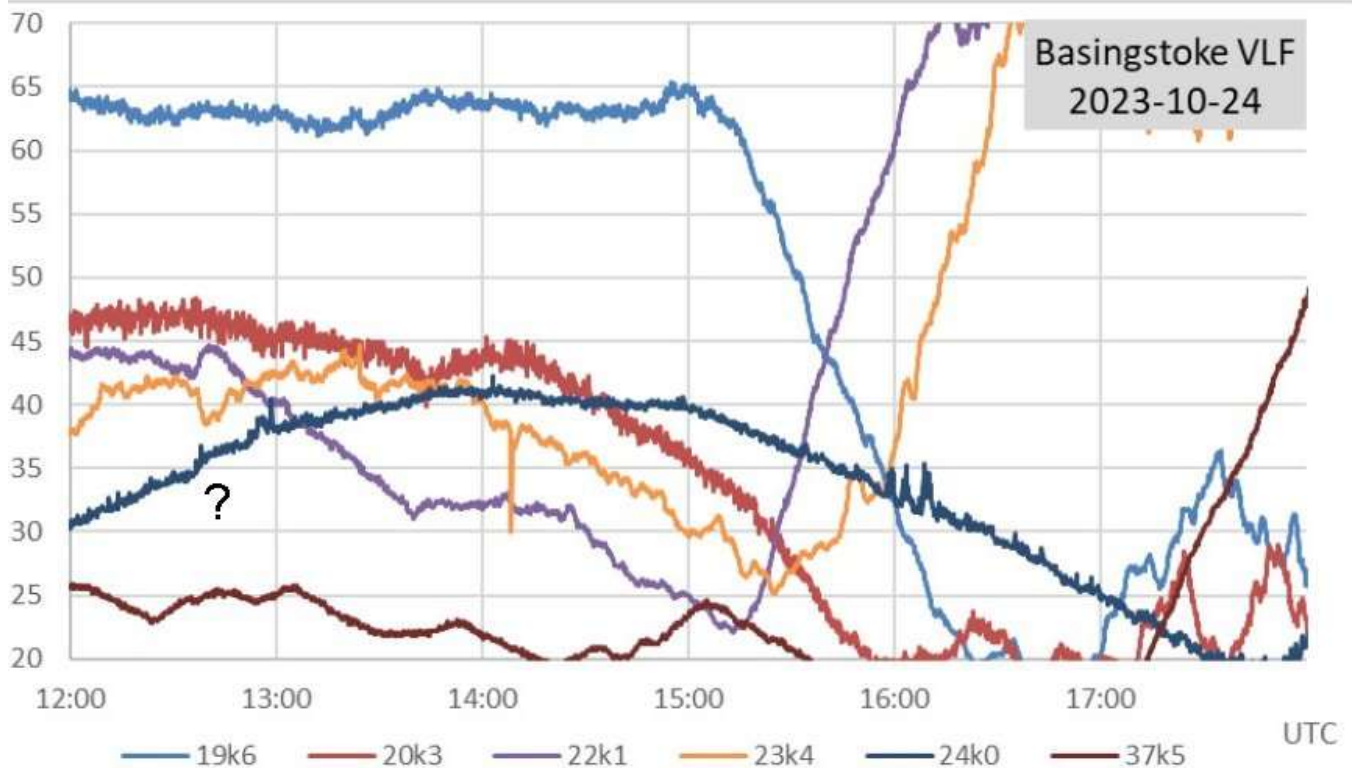

This recording from October 24<sup>th</sup> by Paul Hyde shows a rather puzzling SID-like response at 12:40 on 22.1kHz and 23.4kHz. They are good mirror images, and so probably not transmitter effects. There is also a very small rise in the 24kHz signal. The nearest flare listed in the SPWC satellite data is magnitude B8.6 at 12:26, ending before the SID starts. The rest of the day remained quiet with some small C-class flares, none of which were recorded. The recording also shows the changing sunset times over the various paths; 19.6kHz and 22.1kHz being the earliest, followed 30 minutes later by 23.4kHz, and over two hours later the trans-Atlantic signals at 24kHz and 37.5kHz.

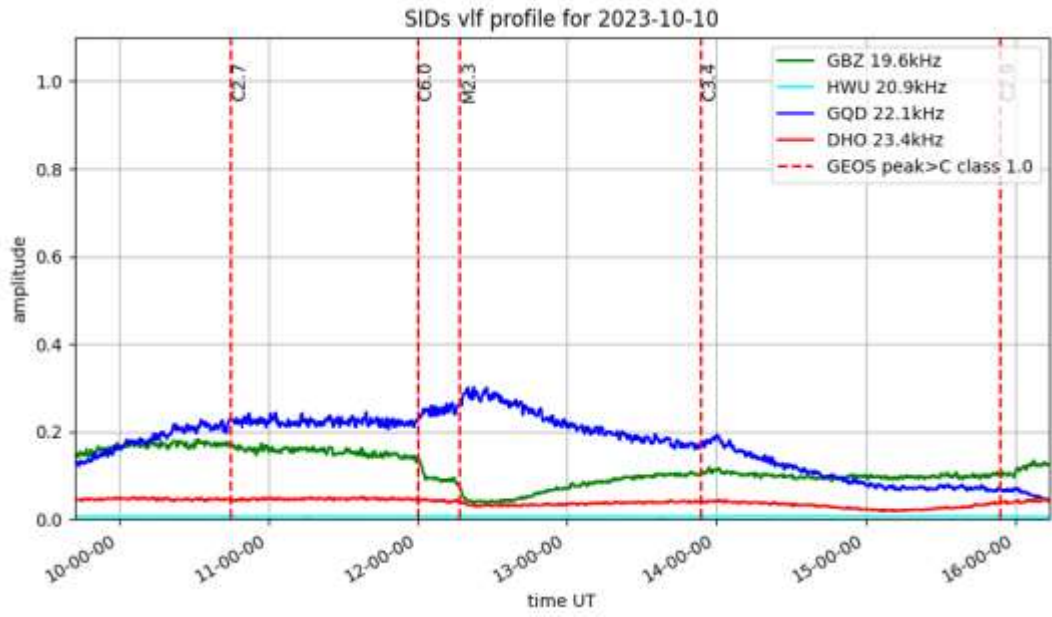

The recording by Mark Prescott from the 10<sup>th</sup> shows the stronger of the two M-class flares recorded. The M2.3 flare has interrupted the earlier C6.0 flare, giving good mirror image SIDs at 19.6kHz and 22.1kHz. 23.4kHz has remained largely unaffected, with just a very minor drop in signal level. Different active regions produced these flares, although they were less than 10 degrees apart. The later C3.4 flare is also well shown at 22.1kHz.

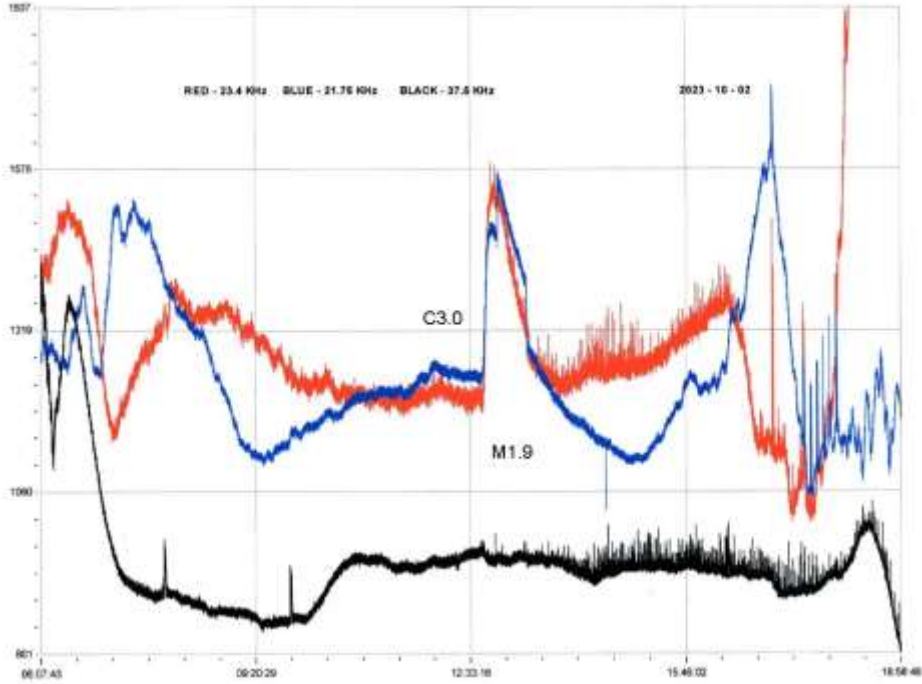

Colin Clements' recording from the 2<sup>nd</sup> shows the M1.9 flare at 23.4kHz (red) and 21.75kHz (blue) with very strong SIDs, along with the much weaker C3.0 flare. The 21.75kHz response appears to be a spike and wave

type SID, although the dip is fairly weak and the following rise very sharp. Grindavik at 37.5kHz remained unaffected.

**MAGNETIC OBSERVATIONS.**

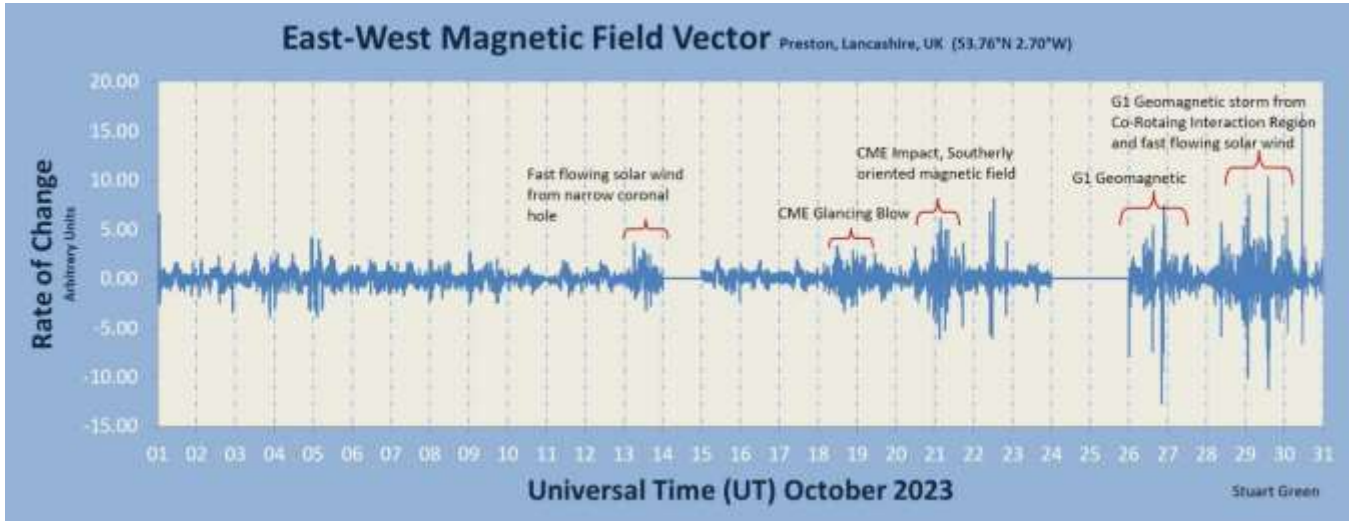

Stuart Green’s monthly summary of magnetic activity shows a very quiet period to start the month, followed by increasing activity. The two gaps were due to local interference that has been removed from the data. There were CMEs associated with some of the stronger flares, but they were mostly not Earth directed, and so caused minimal disturbances. There were also some coronal holes present, resulting in some periods of high-speed solar wind.

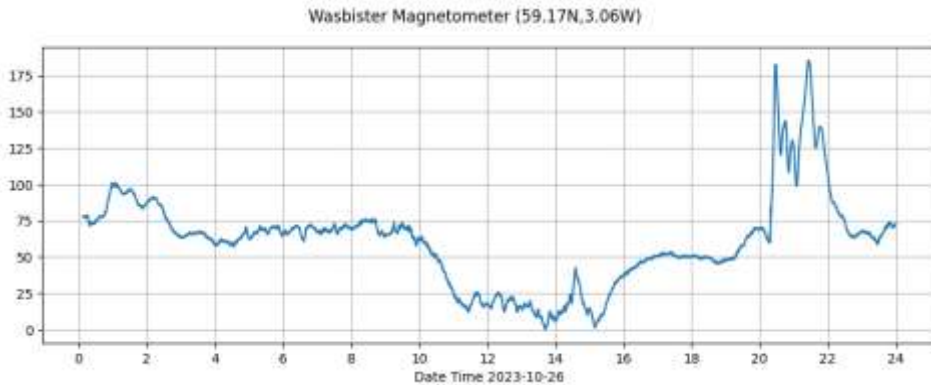

The sudden impact at about 20:30 on the 26<sup>th</sup> is shown here by Callum Potter. It was recorded by all our observers, and appears to be a CME impact, although the source is not known. Its disturbance was very short, fading out the next morning as shown by Roger Blackwell.

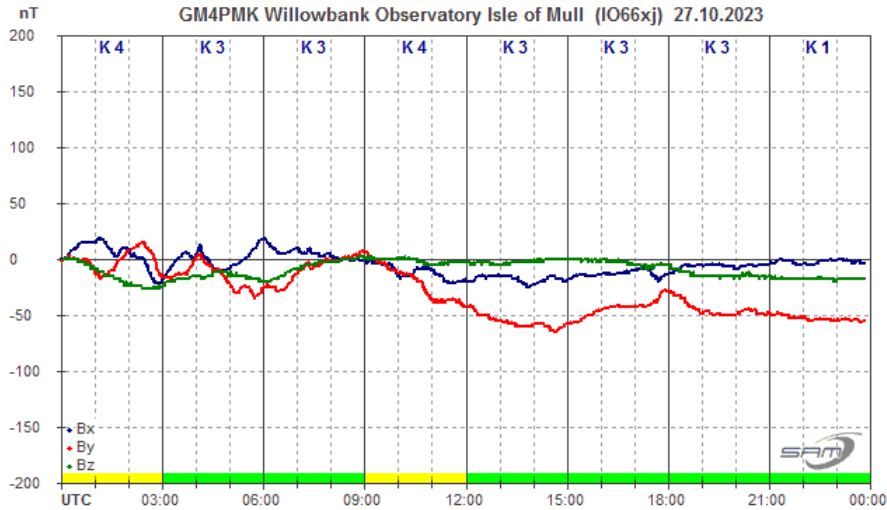

The space weather web site reported an incidence of PC3 magnetic waves on the 17<sup>th</sup>. These were identified by the Lofoten observatory in Norway, showing a period from about 16:40 to 17:10 with a stable sine wave magnetic disturbance. Callum Potter has our most northerly sensor in Orkney, but did not record anything that stands out:

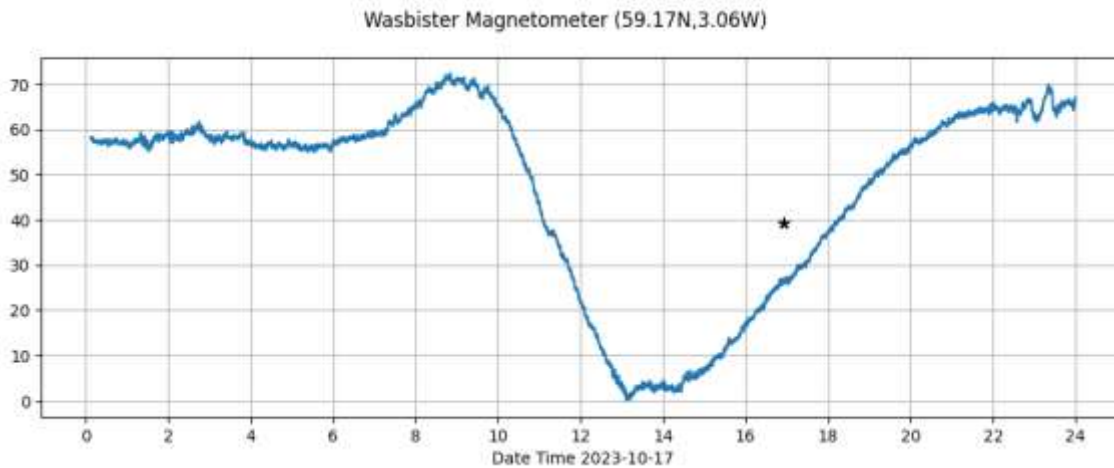

I have marked the position '\*' on his recording. This link is to the space weather item, showing the disturbance in greater detail:

[https://spaceweathergallery2.com/indiv\\_upload.php?upload\\_id=200865](https://spaceweathergallery2.com/indiv_upload.php?upload_id=200865)

These effects are usually seen during periods of very quiet solar activity.

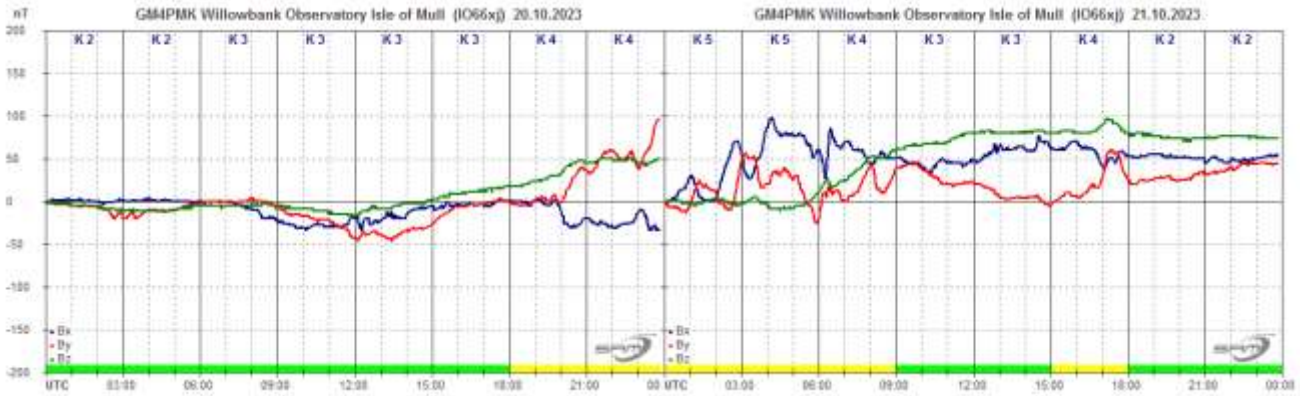

A combination of higher speed solar wind and minor CME impacts produced some moderate disturbance overnight from the 20<sup>th</sup> to 21<sup>st</sup>, shown here by Roger Blackwell.

Steyning Magnetometer (50.8 North, 0.3 West)

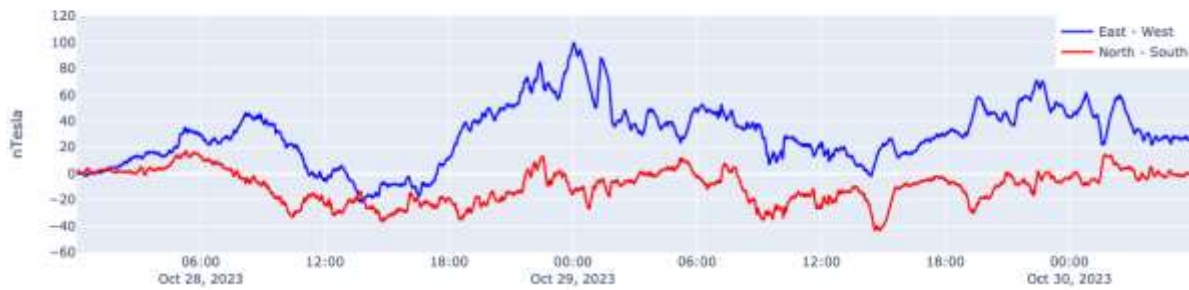

Nick Quinn's recording from the 28<sup>th</sup> / 29<sup>th</sup> shows a similar disturbance, mostly due to a faster solar wind.

Wasbister Magnetometer (59.17N, 3.06W)

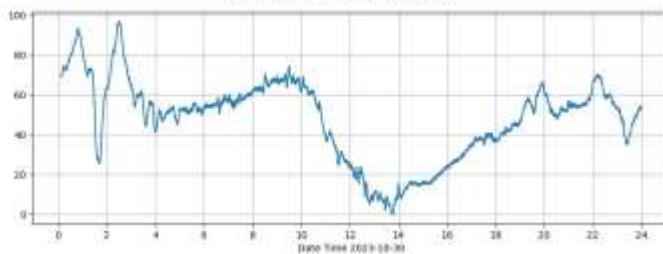

Wasbister Magnetometer (59.17N, 3.06W)

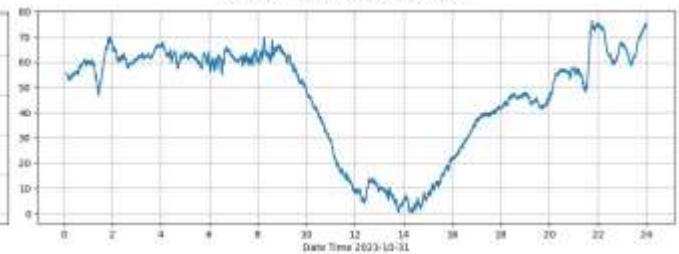

The disturbance continued to the end of the month, shown in Callum Potter's recording. While comparing these recordings, note the different location details covering the north and south of the country.

Magnetic observations received from Roger Blackwell, Colin Clements, Stuart Green, Callum Potter, Nick Quinn, and John Cook.

## SOLAR EMISSIONS.

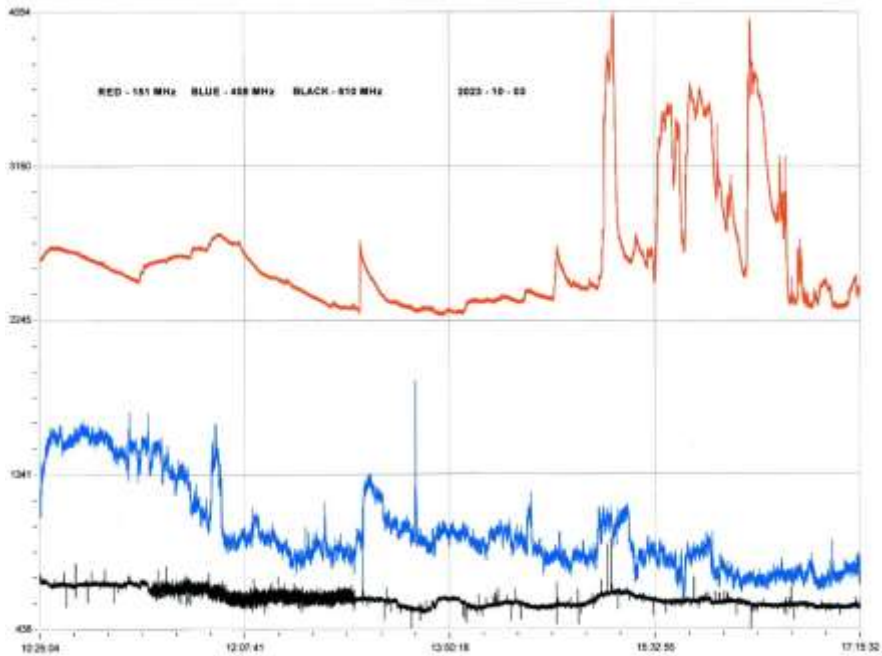

With the sun much lower in the sky, Colin Clements' VHF / UHF aerials are now being shadowed by the local houses. The 151MHz system did manage to detect some emissions in the afternoon of the 3<sup>rd</sup>, probably related to the C- class flares that we recorded. The 408MHz and 610MHz systems showed much less activity due to the shadowing. Colin has been experimenting with alternative aerial designs for use in the house loft during the winter months. These are Bi-Quad designs, using wire mesh reflectors, and vertically polarised to fit inside the loft. The outdoor aerials are horizontally polarised. The 151MHz aerial was under test on the 29<sup>th</sup>, and showed some emissions from the flares on the 29<sup>th</sup>:

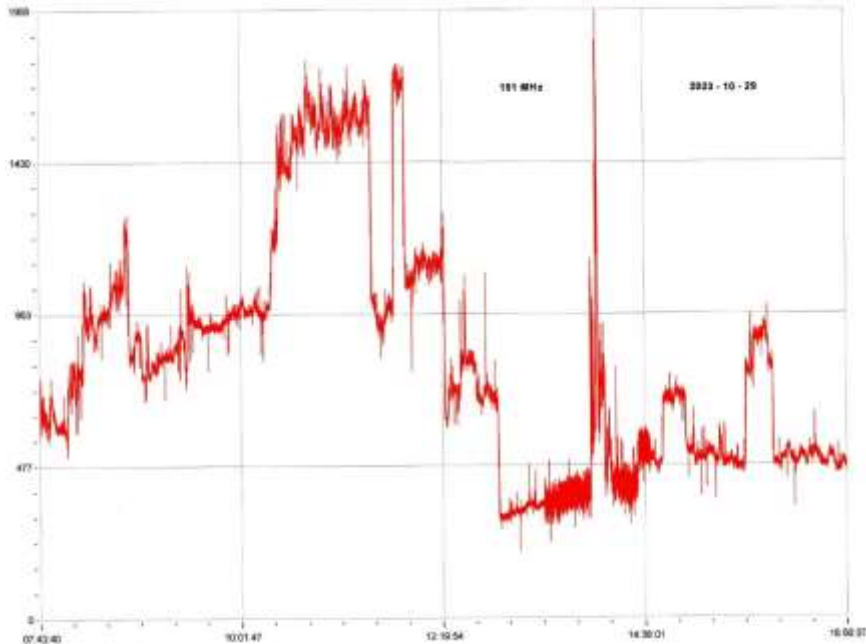

MUONS.

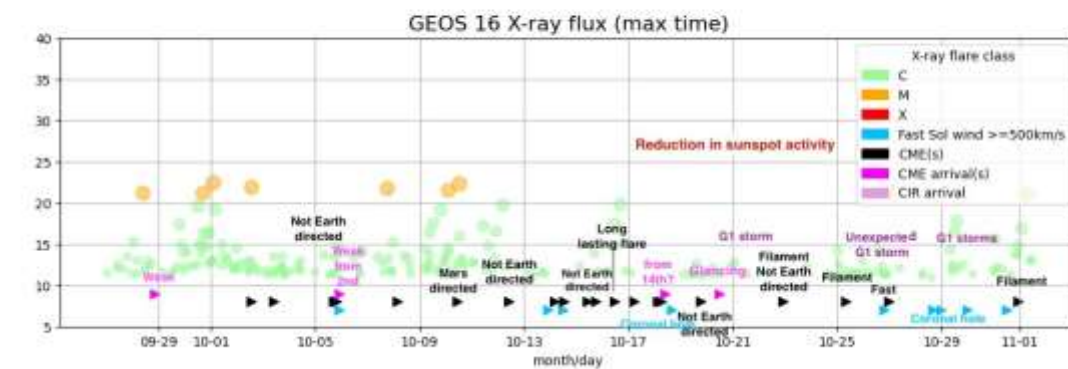
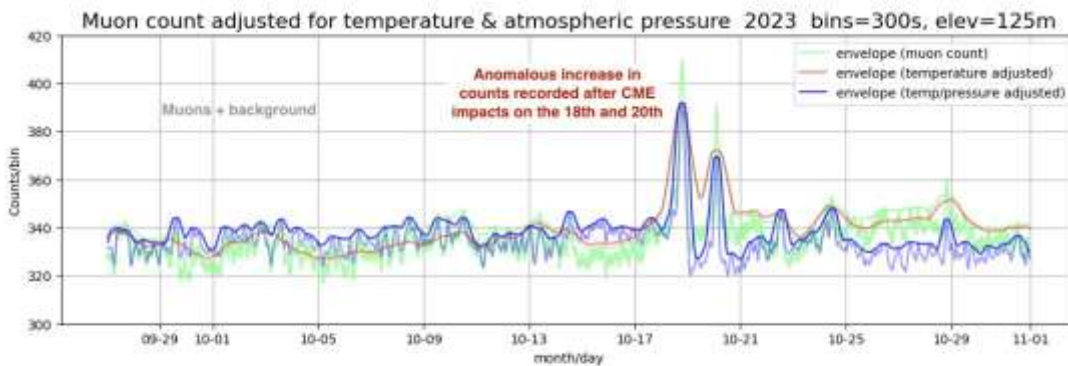

Mark Prescott's muon recording shows two strange peaks in activity on the 18<sup>th</sup> and 20<sup>th</sup>, matching the flares and solar wind recorded in the SID and magnetic data. The magnitude of the muon peaks is much greater than expected. Following these peaks, the temperature / pressure adjusted counts are lower than previously.



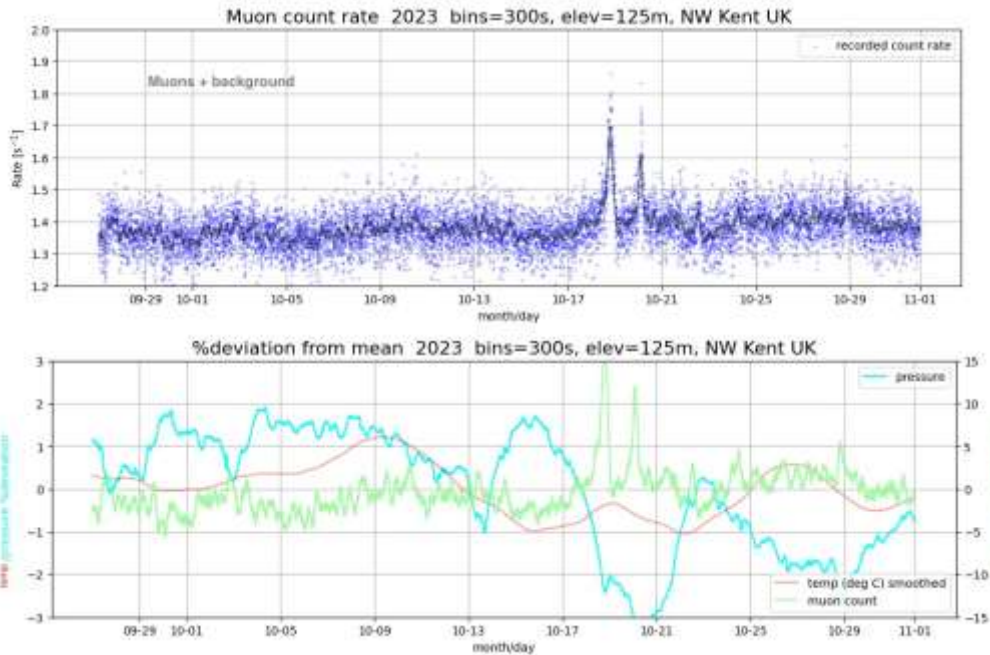

The pressure chart (light blue) also shows a strong drop during these events, so may well have affected the way that the incoming radiation reacts as it reaches our ground level sensors.

**METEORS.**

There were no observations of the October Orionids received. November and December are busy months for meteor activity, and so any reports will be welcome.

At the BAA AGM, John Mason, director of the meteor section, talked of a possible display of Bielid meteors in early December. This is a rarely seen shower, but there have been predictions of a good display this year. Predictions are no guarantee of course, but it would be worth a look. I believe that the predicted date was around the 3<sup>rd</sup>/4<sup>th</sup>.

# BARTELS CHART

YEAR	DAY	DETECTED		ACTIVE		SPE		B, C, M, X = FLARE MAGNITUDE		Specific station start (in green)	
		1	2	1	2	1	2	1	2	1	2
2566	2021 Jan 25										
2567	2021 Feb 20										
2568	2021 Mar 16										
2569	2021 Apr 16										
2570	2021 May 8										
2571	2021 Jun 11										
2572	2021 Jul 4										
2573	2021 Aug 2										
2574	2021 Sep 24										
2575	2021 Oct 20										
2576	2021 Nov 18										
2577	2021 Dec 10										
2578	2022 Jan 10										
2579	2022 Feb 8										
2580	2022 Mar 1										
2581	2022 Apr 1										
2582	2022 May 1										
2583	2022 Jun 1										
2584	2022 Jul 1										
2585	2022 Aug 1										
2586	2022 Sep 1										
2587	2022 Oct 1										
2588	2022 Nov 1										
2589	2022 Dec 1										
2590	2023 Jan 1										
2591	2023 Feb 1										
2592	2023 Mar 1										
2593	2023 Apr 1										
2594	2023 May 1										

### VLF flare activity 2005/23

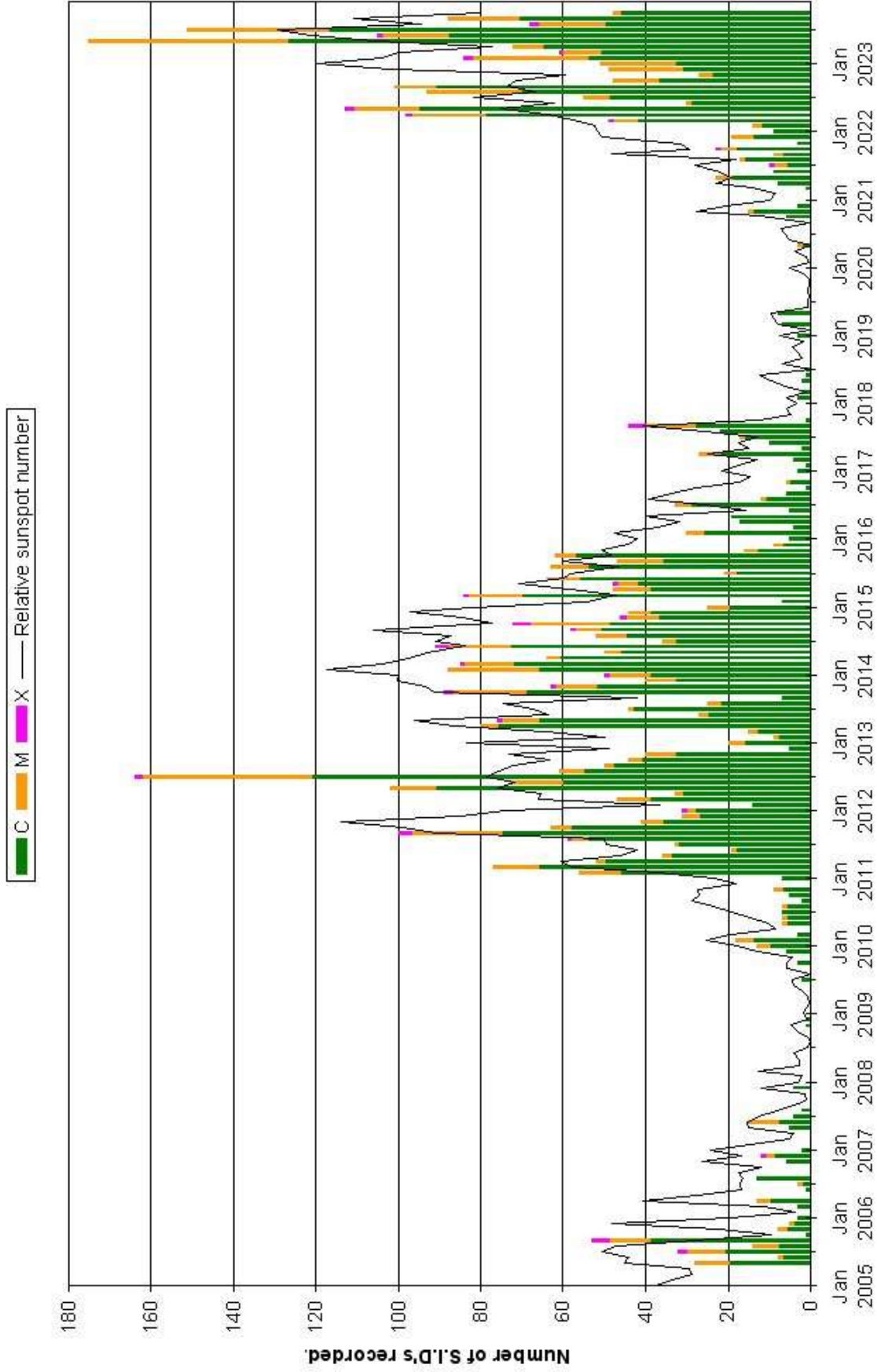



**British Astronomical Association**

Supporting amateur astronomers since 1890

**Radio Astronomy Section**

## BAA RA Section programme 2024

<p><b>Fri. Jan. 5th</b> 19:30 GMT (19:30 UTC)</p>	<p><b>Andrew Thornett</b> ~O~ <b>Martin Bertges</b></p>	<p>Recent endeavours for the search for the H-1 line. ~O~ <b>Home built</b> Cherenkov radiation muon detector</p>
---	---	---

[Join the RA conversation](#)

[Join the muon conversation](#)

[Join the UK Beacon conversation](#)

[Society of American Radio Astronomers](#)

[UK Radio Astronomy Association \(UKRAA\)](#)

[BAA RA YouTube channel](#)

---

**Paul Hearn**  
BAA Radio Astronomy Section Director  
UKRAA Trustee

### ADALM Pluto as Dual Channel SDR for Interferometry

Wolfgang Herrmann

#### 1. Introduction

Dual channel software defined radios (SDR) are of interest for two reasons: They open the possibility to receive two polarizations and to do interferometry. There are a couple of SDRs which have this capability. The product lineup from Ettus research includes several devices designed for dual channel operation. The USRP B210 is one of these [1] but it is comparatively expensive. The original Lime SDR also had two radios, but this unit is no longer available. Then there are products from Nuand with dual channel radios [2]. The KrakenSDR has even five channels but is quite limited in bandwidth [3]. Also, it seems that special procedures are required to provide phase alignment between the channels in the KrakenSDR.

Now there is an additional option: The ADALM Pluto from Analog Devices [4] with its later hardware revisions. It is a comparatively affordable solution which provides two channels after a small modification. This article will explain how to achieve dual channel operation and test its performance for interferometry.

#### 2. The ADALM Pluto software defined radio

The ADALM Pluto software defined radio from Analog Devices has been around for a number of years and has been used at our observatory quite extensively. All software defined radios which we have used so far have their pros and cons. We found that the ADALM Pluto has a good gain stability and an overall flat spectral response. However, the spectral response has a “ripple” which can be annoying. A comparison of various SDRs was published as part of the series of articles on hydrogen observations [5].

Even though the AD9363 radio chip used in the ADALM Pluto is a 2 x 2 transceiver, only one of the radios is made available in the original design of the ADALM Pluto. The AD9363 is specified to cover the frequency range from 325 MHz to 3.8 GHz. However, a “hack” can be made which makes the ADALM Pluto believe it has an AD9361 chip which then covers the range from 70 MHz to 6 GHz. Usually this works quite well although not all specifications may be reached over the full frequency range. There are many places where this easy modification is explained, one is at [6].

Since about a year there is a newer hardware revision (“C” and above) available which provides the option to make use of the second radio of the chip.

#### 3. How to enable dual channel operation of the ADALM Pluto

One of the hardware changes with the Revision C of the ADALM Pluto is that the second receive and transmit channels are available at u.FL connectors on the board. So, while these second channels are not immediately accessible from the outside, additional u.FL – SMA cables can be added. There is an excellent YouTube video which describes the process and I highly recommend using this as a guideline [7]. This video not only describes the

hardware additions, but also describes how to configure the device to support dual channel operation. Last but not least, the video describes how to use the two channels with a Python program.

Our version of the change is depicted below in fig. 1. Since there is sufficient space for three additional SMA connectors we have opted to bring out the second receive channel and both clock in and out signals. It is worth noting that the clock out signal is only available if a clock in is provided, and the unit has been set to external clocking.

In our setup we have not used the second TX channel as we do not need the TX in our application.



Figure 1: Modified ADALM Pluto (Rev. C board)

#### 4. Testing

Our main interest at present is to use the device for interferometry. Therefore, we have done tests for this application where two test signals with adjustable phase are provided to the SDR.

The test setup is depicted below in fig. 2.

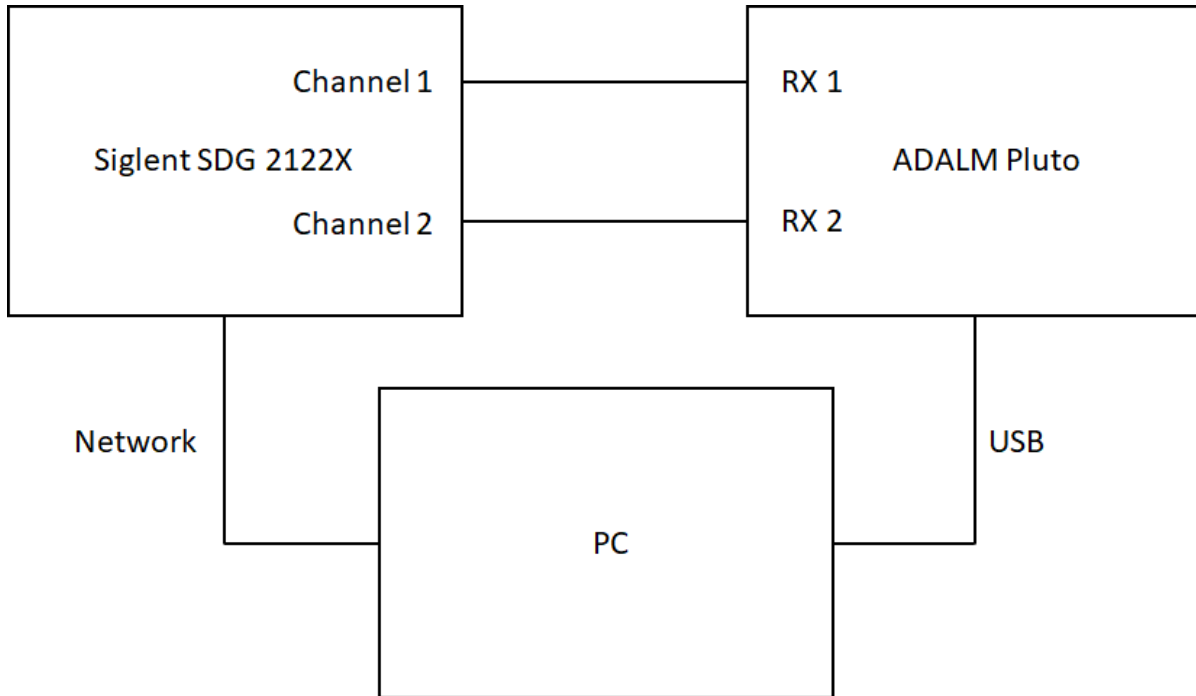

Figure 2: Test Setup

A Siglent SDG 2122X signal generator is connected to the two RX input ports of the ADALM Pluto. The signal generator has two output ports which can be set to have the same signal however with an adjustable phase difference. The phase setting can be controlled via a PC. The same PC connects to the SDR and collects the IQ samples from both channels.

So, we are receiving two IQ samples,  $I_1Q_1$  and  $I_2Q_2$ .

These are processed by multiplying one sample with the complex conjugate of the other sample (eq. 1) and forming the vector sum of both signals, squared to deliver power (eq. 2).

$$z = (I_1 + Q_1) * (I_2 - Q_2) \tag{1}$$

$$p = (I_1Q_1 + I_2Q_2)^2 \tag{2}$$

These signals have been recorded over a phase variation range of  $0^\circ$  to  $1440^\circ$  (4 cycles). The result is shown below in fig. 3. Since the phase signal  $z$  is a complex number, the plot shows the real and the imaginary part separately.

As can be seen, the phase detection is almost perfect. As expected, the real and imaginary parts of the phase signal are shifted by  $90^\circ$ . The power signal is 0 at  $0^\circ$  phase angle which indicates that the two signals are shifted by  $180^\circ$ . If that is a concern in an application, this can be fixed by using  $-I_2-Q_2$  in the calculation of eq. 2.

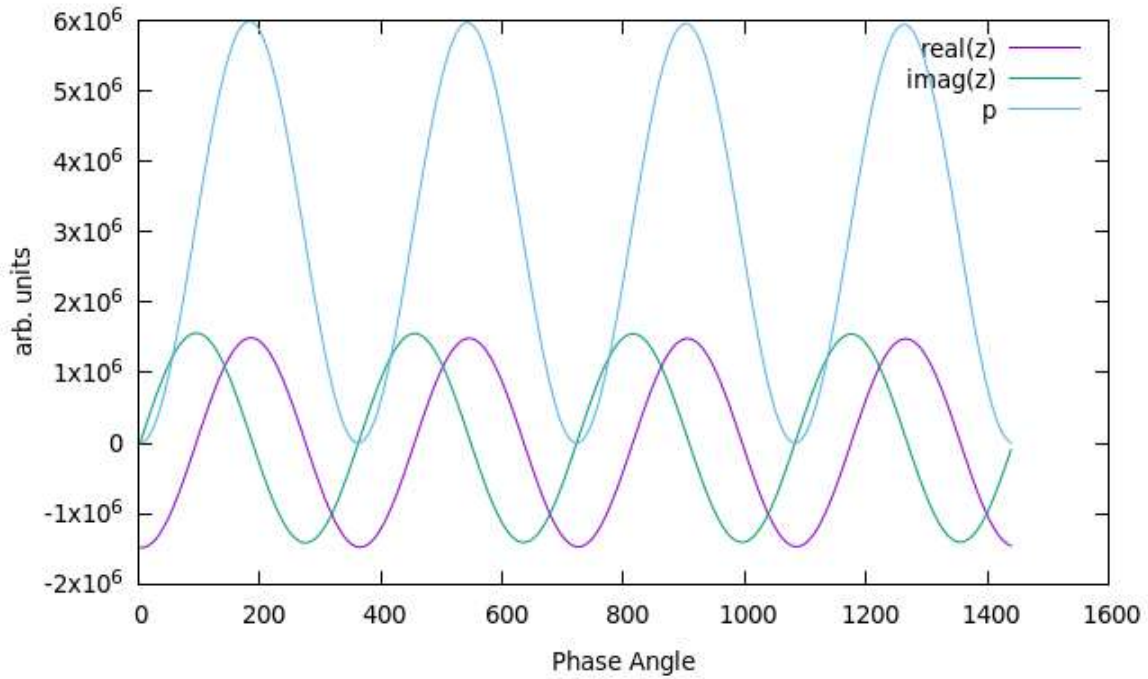

Figure 3: Recorded phase and power signal

Also, the repeatability was tested by comparing the phase signal from two runs. In between the runs the ADALM Pluto was disconnected from the USB port so that a cold start of the Pluto was forced. There is a perfect alignment between the two tests as shown in fig. 4. The traces from run two lie exactly on top of the previous run and are indistinguishable.



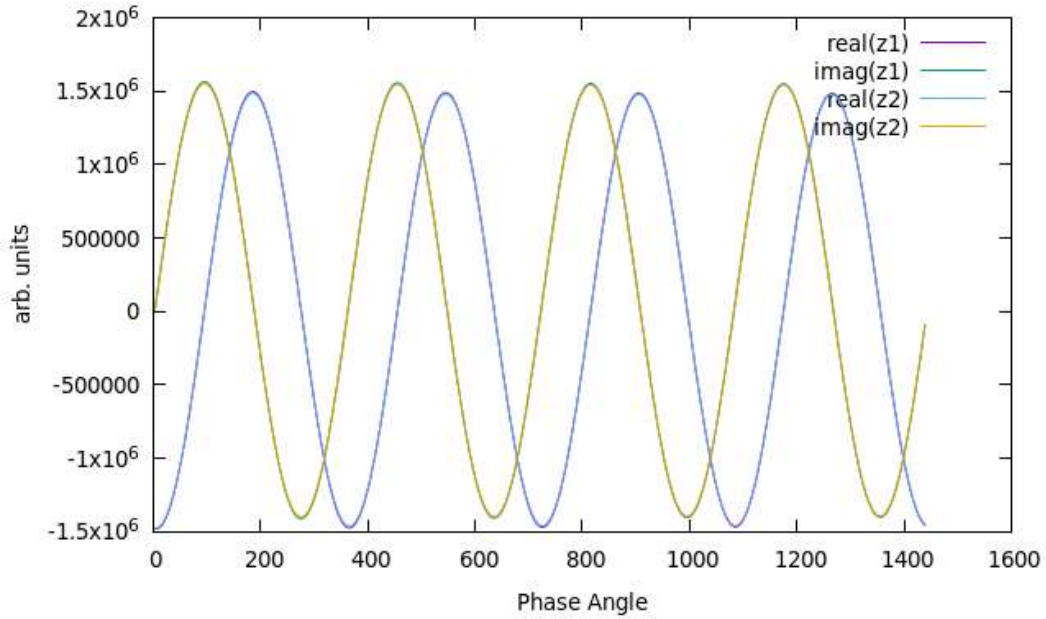

Figure 4: Phase signal of two runs

Next the phase stability was tested. For this purpose, a signal was split up by a 3dB splitter and connected to both receiver ports. This 3dB splitter introduced a phase shift of about  $34.6^\circ$ .

The phase angle between the two signals was calculated in the software and the result was recorded over more than three hours, see fig. 5.

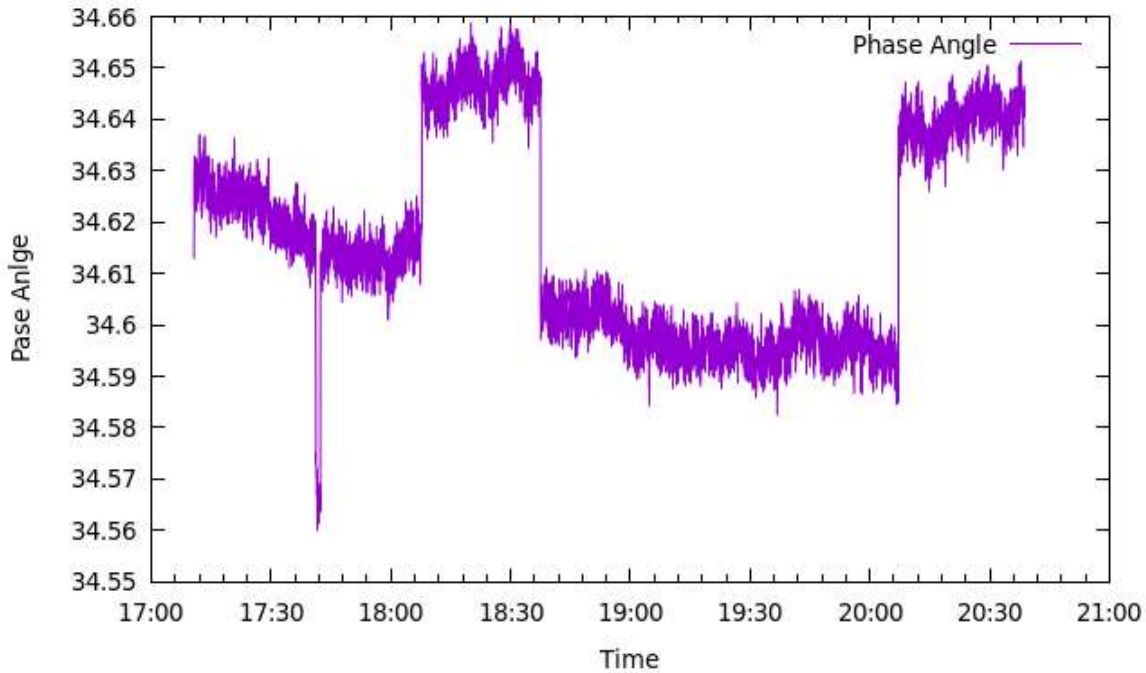

Figure 5: Phase variation over time

Besides a small drift there were some jumps. However, the overall variation stayed within  $0.1^\circ$  which is perfectly fine for our purpose.

### 5. Real world example

The data shown above has all been taken in the laboratory. Of course, verification of lab results in the real application is required.

A test was made using the Ku-band interferometer setup at our observatory. This is a meridian transit instrument with two 1.2-m dishes equipped with PLL-type LNBS, clocked from a common reference signal. The baseline of the instrument is 10.3 meters. The recording was taken with a 10 MHz sampling rate at an IF frequency of 1500 MHz. This converts to a sky frequency of 11.1 GHz.

Of course, at this frequency and baseline, the fringe spacing is smaller than the diameter of the sun. Therefore, the fringes are not as pronounced as they would be for a more compact object. Nevertheless, due to the high flux of the sun this is sufficient as a proof of concept experiment.

The result (i.e. the fringes) can be seen in fig.5. The fringe time is  $\sim 37$  seconds.

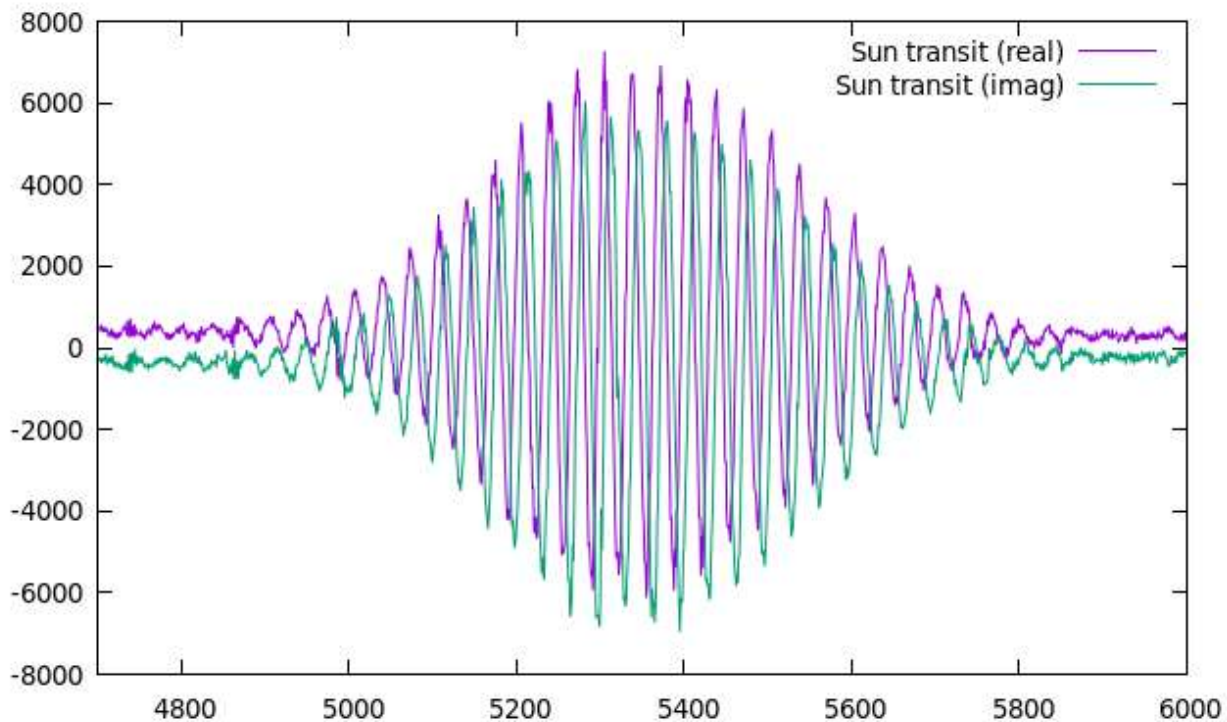

Figure 6: Fringes from a sun transit

### 6. Conclusion

The ADALM Pluto with hardware revision C and above is a software defined radio which can easily be modified to work as a dual channel receiver. The phase between the two receivers is stable and thus allows interferometry experiments. This unit is probably the most affordable solution at the time of writing which just works without having to worry about synchronization.

### Literature and Web-Links:

[1] <https://www.ettus.com/all-products/ub210-kit/>

[2] <https://www.nuand.com/>

[3] <https://www.krakenrf.com/>

[4] <https://www.analog.com/en/design-center/evaluation-hardware-and-software/evaluation-boards-kits/adalm-pluto.html>

[5] SARA Journal

[6] <https://www.rtl-sdr.com/techminds-performing-the-frequency-expansion-and-cpu-core-mod-on-the-plutosdr/>

[7] <https://www.youtube.com/watch?v=ph0Kv4SgSul>



**About the Author:** Dr. Wolfgang Herrmann is the president of the "Astropheiler Stockert e.V.", the organization which operates the observatory.

He received his PhD in Physics from the University of Bonn. He has spent most of his professional career in the telecommunication industry. At retirement age, he now enjoys learning as much as possible about radio astronomy, doing observations and improving the instruments at Astropheiler.

Contact the author at [messbetrieb@astropeiler.de](mailto:messbetrieb@astropeiler.de)

## Evaluation: 4 Small Radio Telescope Systems for Hydrogen Line Acquisition

Alex Pettit Oct 2023

A Qualitative Comparison of four radio telescope systems was performed.  
using parabolic reflectors from 1.2 meters to 3.7 meters in diameter.

Two systems used Spectra Cyber 1420 MHz Spectrometers,  
Two used Software Defined Radio (SDR) (Receiver / Analog to Digital Converter) Systems.

The 1.2m SDR and the Spectra Cyber 3.7m system used the same RAS (WD5AGO) Low Noise Amplifier.  
The SDR based 3.7m radio telescope used the nooelec SAWbird+ H1 LNA

### Data Acquisition

The data sets were from 24 hour drift scans at a Declination of approximately + 40 degrees.

(1.2m +40°, 2.7m +40°, 3.7m\_SDR +36°, 3.7m\_SpecCy +37° ) .

Each scan (file) was acquired over a 4 to 5 minute time frame (1° to 1.25° drift in RA)

### Comparisons

=====

#### 1.2m Dish with SDR Rx/ADC

The 1.2 m dish shows the greatest difference between Cold\_Sky and Peak H1 brightness. This is probably the result of the deep  $f/D = 0.27$  reflector reducing the 290K ground noise pickup.

The wide beamwidth of the 1.2m reflector captures a wide area of the sky but lowers its ability to resolve details.

With a software defined radio (SDR), all frequency channels are simultaneously acquired. A 300 second scan allows 300 seconds of data to be acquired and averaged for each frequency channel thus providing good statistical convergence (smoothing) of the random data.

Software: Air Spy SDR# Studio with IF\_Ave plug-in for acquisition, averaging and file saving.

The dB scale is referenced to Cold\_Sky = 0 dB.

Cold\_Sky vs Peak H1 brightness (2.9 dB) = 1.95:1 Power Ratio

The plot amplitude calibration was verified using a series of attenuators.

The data file frequency resolution: 2.93 kHz ( 512 ch FFT )

Antenna Beam-Width FWHM 1.2meter dish = 21.1 degrees

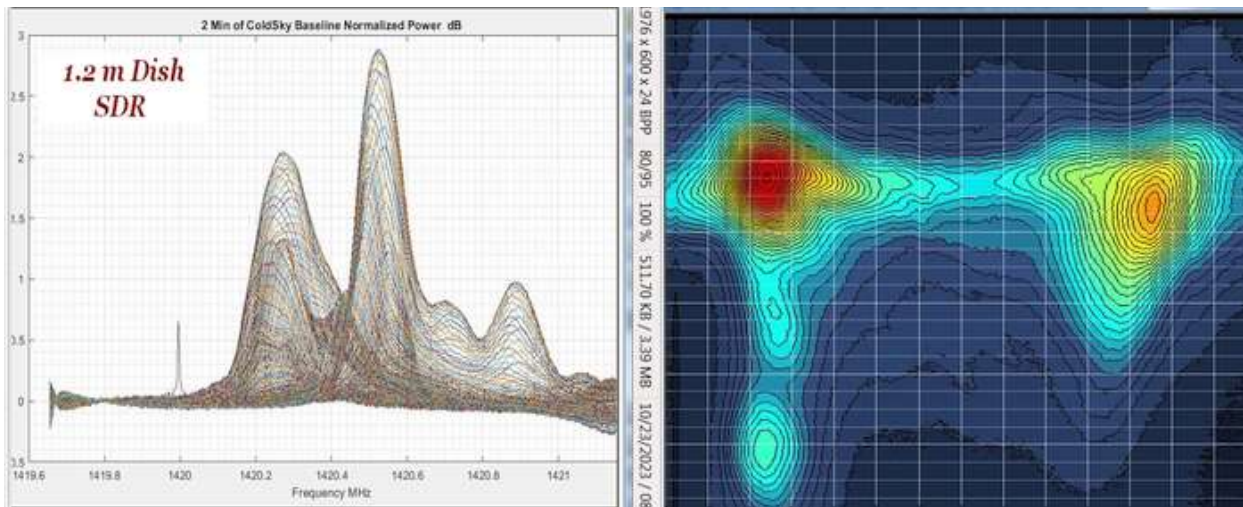

=====

**2.7m and 3.7m Dish with Spectra Cyber Spectrometer Analyzer**

These systems show the result of using a Spectra Cyber "stepped frequency scanner " Spectrometer.

By setting a Sample and Integration Time of 1 second, each frequency channel takes one second to be acquired. A full frequency set of 280 channels thus requires 280 seconds, but each frequency channel is averaged over only one second.

The Spectra Cyber displays and saves data scaled in "Volts". It is related to signal power, but this has not as yet been quantified. The plot amplitude, "Volts" (power); the frequency scale is ' freq channels'.

There is more spatial detail being resolved in the 2.7m and 3.7m dishes over the 1.2m, but the lower signal from one second duration per channel acquisition and lessened statistical averaging masks much of that improvement.

The 2.7m and 3.7m systems have similar H1 Peak signal levels relative to Cold\_Sky. There is slightly more spatial resolution shown in the larger 3.7m reflector data.

Software: Spectra Cyber Software for acquisition, averaging and file saving.

The (uncalibrated) power amplitude is referenced to Cold\_Sky = ' 1.0 '

Uncalibrated Cold\_Sky vs Peak H1 brightness for each ~ 5.2:1 (Power Ratio ?)

The data file frequency resolution: 5.0 kHz

Antenna Beam-Width FWHM 2.7meter dish = 9.40 degrees

Antenna Beam-Width FWHM 3.7meter dish = 6.85 degrees

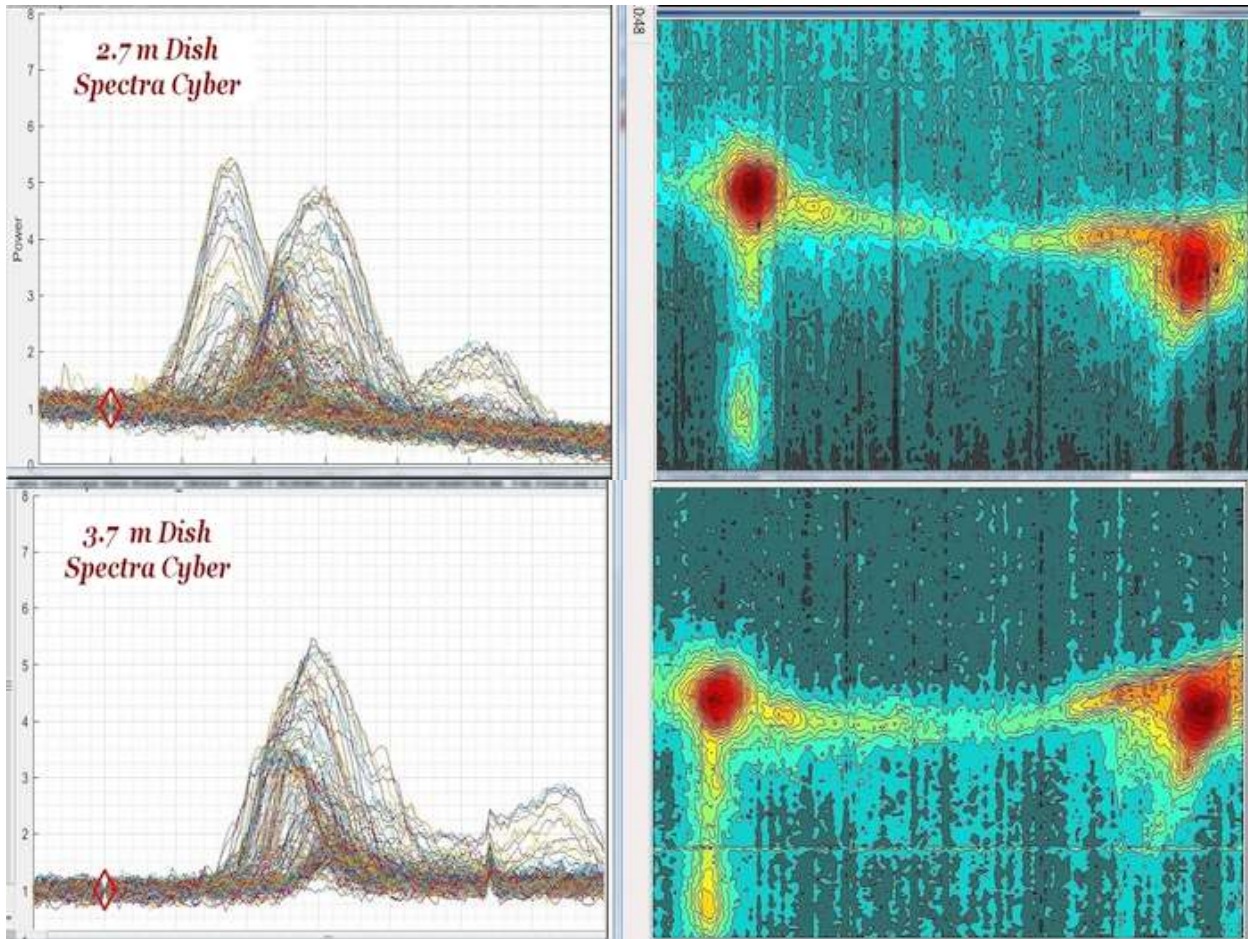

=====

### 3.7m Dish with SDR Rx/ADC

The 3.7 m dish shows up to 2.1 dB difference between Cold\_Sky and Peak H1 brightness.  
 The more narrow beam width allows this antenna to resolve greater spatial details.

With a software defined radio (SDR), all frequency channels are simultaneously acquired. A 300 second scan allows 300 seconds of data to be acquired for each frequency channel thus providing good statistical convergence (smoothing) of the random data.

Software: Air Spy SDR# Studio with IF\_Ave plug-in for acquisition, averaging and file saving.

The dB scale is referenced to Cold\_Sky = 0 dB.

Cold\_Sky vs Peak H1 brightness (2.1 dB) = 1.62:1 Power Ratio

The data file frequency resolution: 6.24 kHz ( 512 ch FFT )

Antenna Beam-Width FWHM = 3.7meter dish = 6.85 degrees

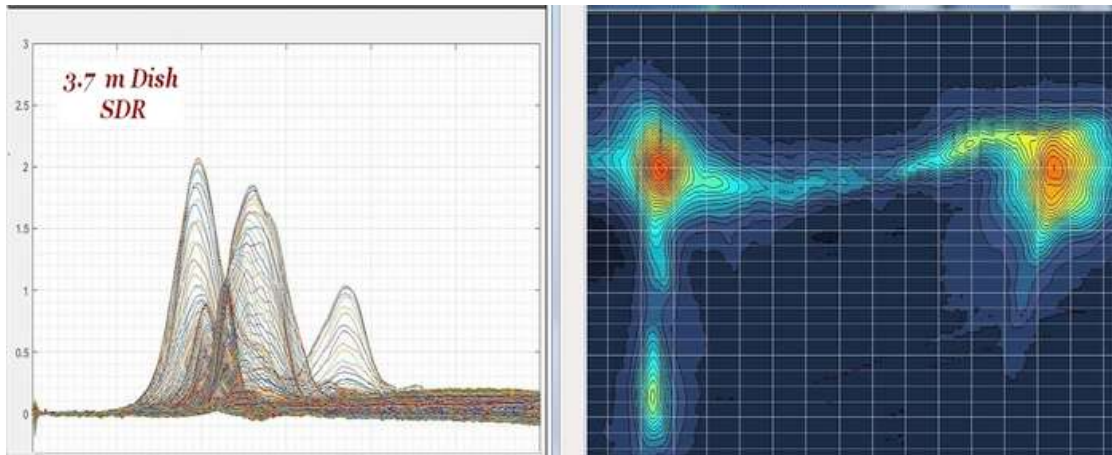

=====

**Hydrogen Line Resolution: 1.2m Parabolic Dish vs 3.7m Parabolic Dish**

**An interesting performance comparison of two parabolic reflectors**

Both Spatial Brightness and Doppler Velocity Resolution is correlated to the beam size.

The 1.2m dish captures a larger area of the sky but at a reduced resolution. It creates an overall average in Brightness and Doppler shifted Velocity from its wide 'field of view' of Milky Way neutral hydrogen clouds.

The more narrow beam-width of the 3.7m dish captures a smaller 'slice' of the neutral hydrogen clouds. This enhances its ability to resolve details in Brightness and Doppler shifted Velocity within its 'field of view'.

Milky Way Drift Scans @ Dec +40 Degrees, RA 00:00 to 08:00 Hrs

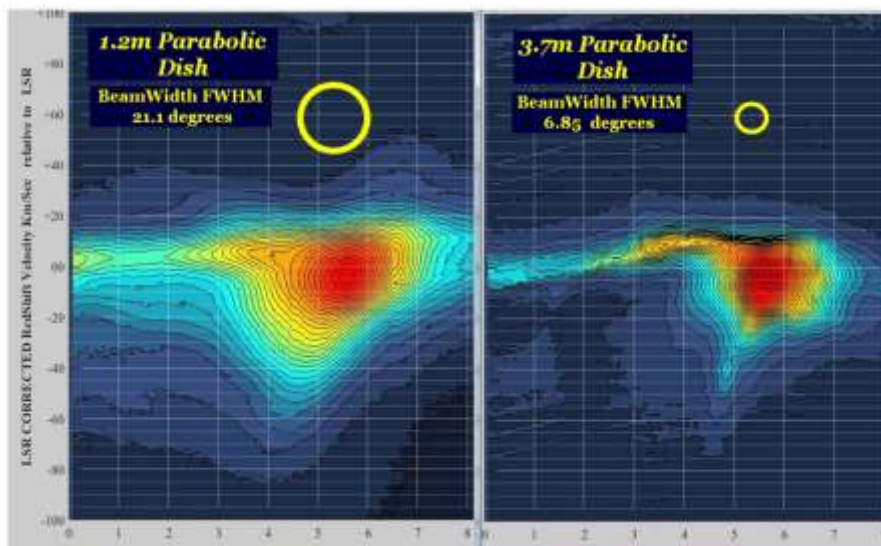

*Thanks to Richard Russel, Wolfgang Hermann, Charles Osborne, and Preston Ozmar for contributing their data in support of this project.*

## A Jansky Solar Polarization Radio at 11.7 GHz and 12.2 GHz

By Rodney Howe, Paul Oxley

*“Hi Rich,*

*We (Paul and I) were both at the SARA conference at GBT in summer 2007. We’d known each other for many years through DSES at Table Mountain, where Paul helped us set up OH and HI receivers for the 18 meter dishes there. I had asked Paul if he could build a solar radio to detect ELF plasma waves on the sun. He said sure it would be a nice challenge! Here’s a couple pics during that meeting.*

*Rodney”*



### Abstract

Choosing the appropriate polarization frequencies on the surface of the sun at 11.7 GHz and 12.2 GHz we test for a couple of possible phenomena: (1) in a polarized recording of data, can we measure electromagnetic wave polarizations in both electric and magnetic components during a solar minimum (2010). (2) the temperatures that are being measured at 11.7 GHz are approximately 15,000 Kelvin and the temperature at 12.2 GHz is approximately 17,000 Kelvin, (Athay, G.,1986). The plasma polarization between these two temperatures could be a measure of the thermal Doppler motion at the solar surface as polarization amplitude differences vary between two LNB frequencies.

### Introduction:

A radio receiver capable of detecting polarizations of thermal plasma motion requires the ability to output in frequency buckets that are separated by a two Hertz snapshot of the sun during a drift scan. In addition, the output of the Local Oscillator (LO) must be low enough to not contribute significantly to the desired result. This allows the analysis to discriminate between the polarization components of the received signal from those of the solar normal



drift scans. Paul Oxley's (2007) solar radio uses an Invacom QPH-031 dual polarities, dual frequency LNB that is available from the Receive Only Satellite market.

*Table 1: Receiver stability requirements for measuring polarization waveforms on Sun.*

<b>Long Term Frequency Stability</b>	<b>+/- 100 ppm Max</b>
<b>Short Term Frequency Stability</b>	<b>10 Hz/Second</b>
<b>Power Output</b>	<b>+13 dBm</b>
<b>Tones (All sources)</b>	<b>-18 dBc</b>

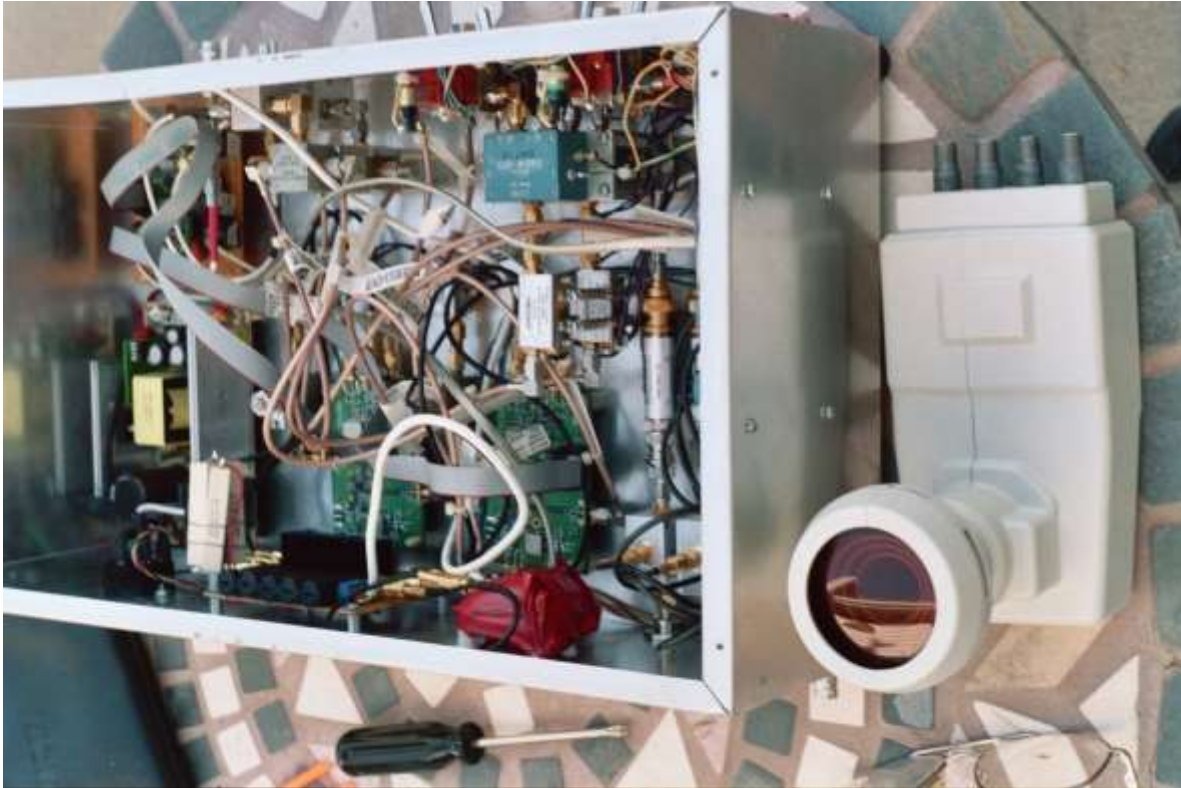

*Illustration 1: A 90 centimeter offset dish with Invacom QPH-031 dual polarity dual frequency LNB.*

**Methods:**

Paul Oxley's solar radio uses an Invacom QPH-031 dual polarities, dual frequency LNB that is available from the Receive Only Satellite market. The four LNB outputs are at L Band Intermediate Frequency (IF) (950 MHz to 1450 MHz). The two linearly polarized inputs are in the frequency band 11.7 GHz to 12.2 GHz. The circular polarity inputs are in the band 12.2 GHz to 12.7 GHz. The IF is down converted to base band and sampled by a 20 MHz A/D converter using the National Instruments PCI5102 board. The two frequencies are phased locked (PLL) down to 2

Hertz, which are the polarizations of interest. Table 1 lists the receiver stability requirements for measuring polarization waveforms on the Sun. Illustration 2 shows the Invacom QPH-031 dual polarity dual frequency LNB to the right of the opened chassis view of Paul Oxley's receiver. Illustration 1 shows the Invacom QPH-031 dual polarity dual frequency LNB on a 90 cm offset dish.



*Illustration 2: Paul Oxley's receiver (left), Invacom QPH-031 dual polarity dual frequency LNB (right).*

**Results:**

For every daily Sun Scan there is a 2 second snapshot taken at the peak of the sun scan. These data from all 4 channels are captured as Angle, Imaginary, Real and Magnitude values (Jansky measures). Then a FFT run does a quadrature cross correlation at 2 Hertz bins. When all values are positive together there is a good chance, we are detecting different polarization amplitudes across the face of the sun.

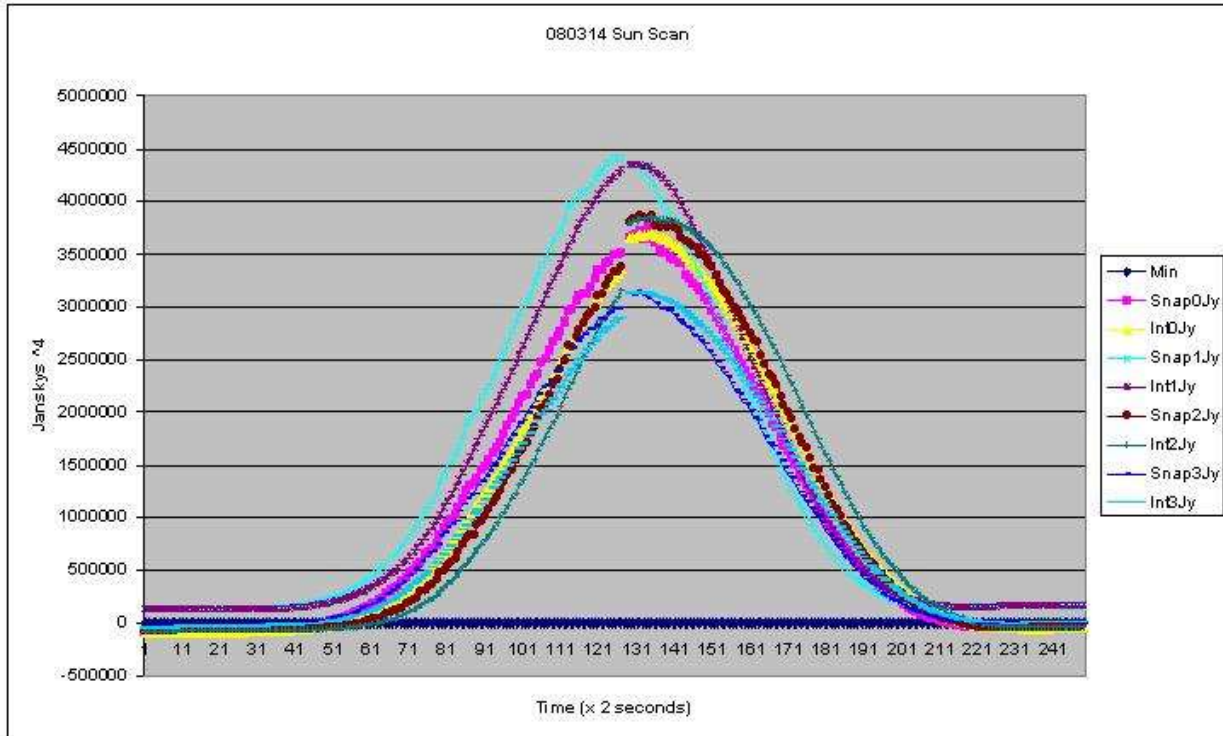

Illustration 6: Channels 0 - 3 during a Sun Scan. There is pause near the peak where a 2 minute snapshot of data was taken for the Quad Cross Correlation routines to examine the polarization of Vertical, Horizontal, Right Circular and Left Circular polarization measured in Janskys.

Quad Cross Correlation routines:

```
ptr0 = ch0fftptr;
ptr1 = ch1fftptr;
ptr2 = ch2fftptr;
ptr3 = ch3fftptr;
crossptr = fftcode->compalloc(ch0FFTsamps);
    ELF_FFTEditCntl->Insert("QUAD CROSS DATA\nFREQ,REAL,IMAG,MAG,ANGLE\n");
    i = 0;
for(ptr=crossptr; ptr!=NULL; ptr = ptr->next) {
    if(i > ch0FFTsamps/2) break; // Printout lower half +1
    if(ptr0 == NULL || ptr1 == NULL || ptr2 == NULL || ptr3 == NULL) break;
    // Create Products
    ptr->freq = ptr0->freq;
    ptr->mag = sqrt(sqrt(ptr0->mag) * sqrt(ptr1->mag) *
    sqrt(ptr2->mag) * sqrt(ptr3->mag));
    ptr->angle = (ptr0->angle + ptr1->angle + ptr2->angle +
    ptr3->angle) / 4;
    ptr->real = ptr->mag * cos(ptr->angle);
    ptr->imag = ptr->mag * sin(ptr->angle);
    sprintf(buf,"%0.1f,%g,%g,%g,%g\n",
        ptr->freq ,
```

```

ptr->real * meanJy / bw // Restore Jy Val
,ptr->imag * meanJy / bw
, ptr->mag * meanJy / bw
,ptr->angle );
ELF_FFTEditCntl->Insert(buf);
i++;
ptr0 = ptr0->next;
tr1 = ptr1->next;
ptr2 = ptr2->next;
ptr3 = ptr3->next;}
ELF_FFTEditCntl->Insert("END QUAD CROSS DATA\n");

```

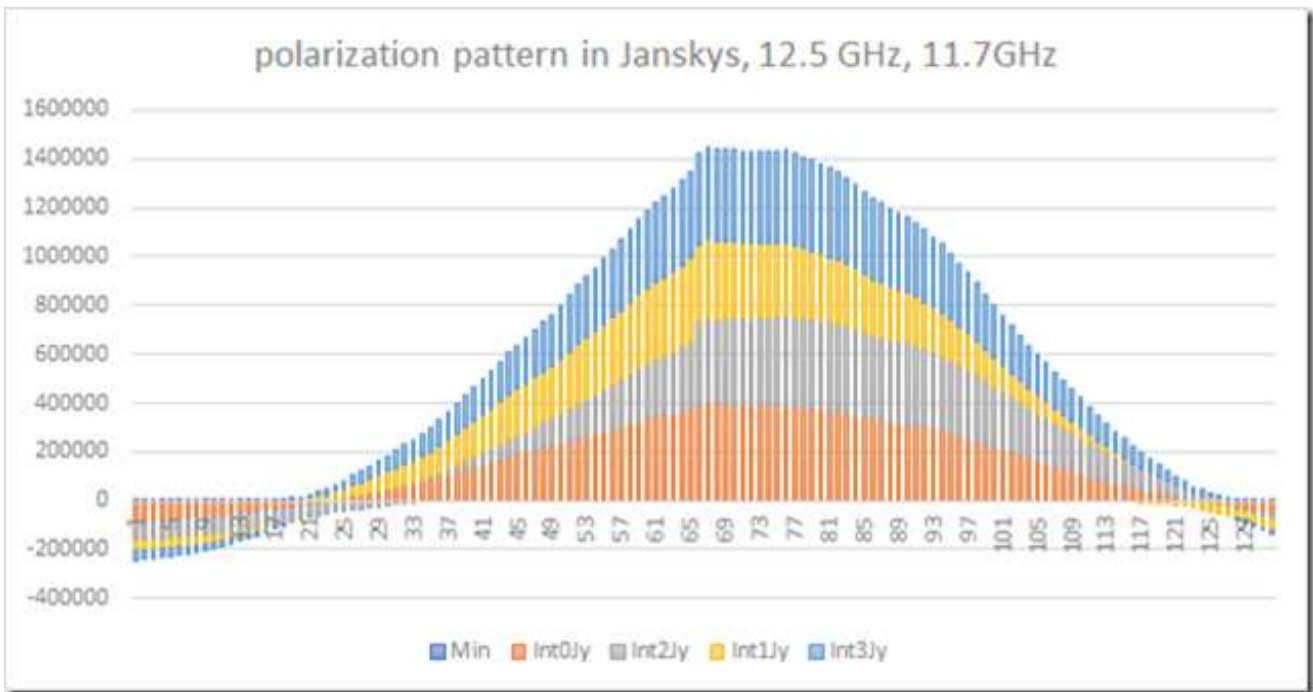

*Illustration 7: The above graph shows the polarization intensities in Janskys for each of the Vertical (int0Jy), Horizontal (int2Jy), Right Circular (int01Jy) and Left Circular (int3Jy) frequencies from the 12.2 GHz and 11.7 GHz LNBS.*

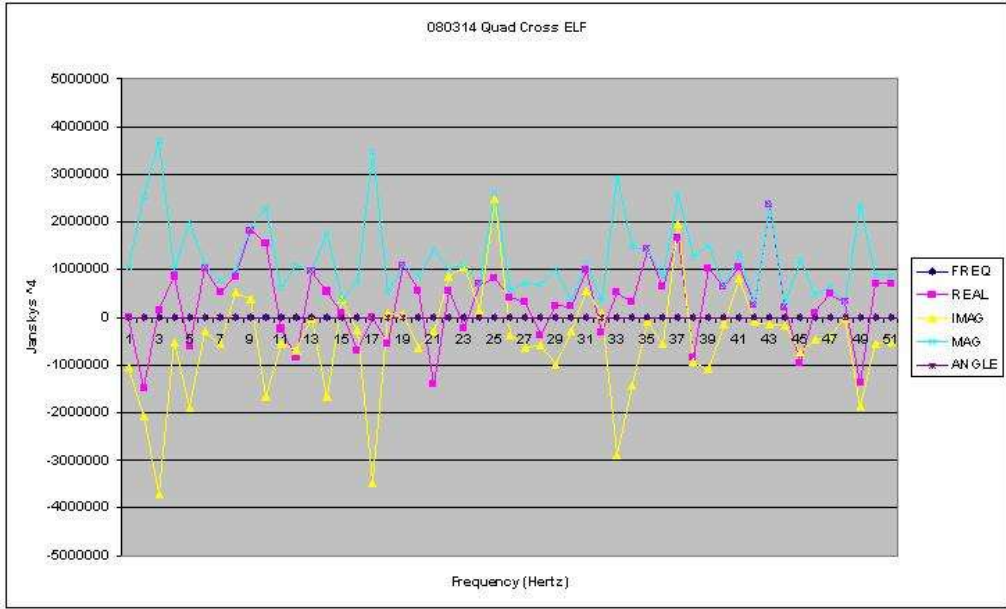

Illustration 8: This is the result of a Quad Cross Correlation starting at 0 Hertz to 100 Hertz (in 2 second bins). When Angle, Real, Imaginary, and Magnitude values (Jansky measures) are positive there may be a significant correlation between the two frequencies and a possible indication of a mixture of polarizations at different amplitudes, and altitudes on the sun.

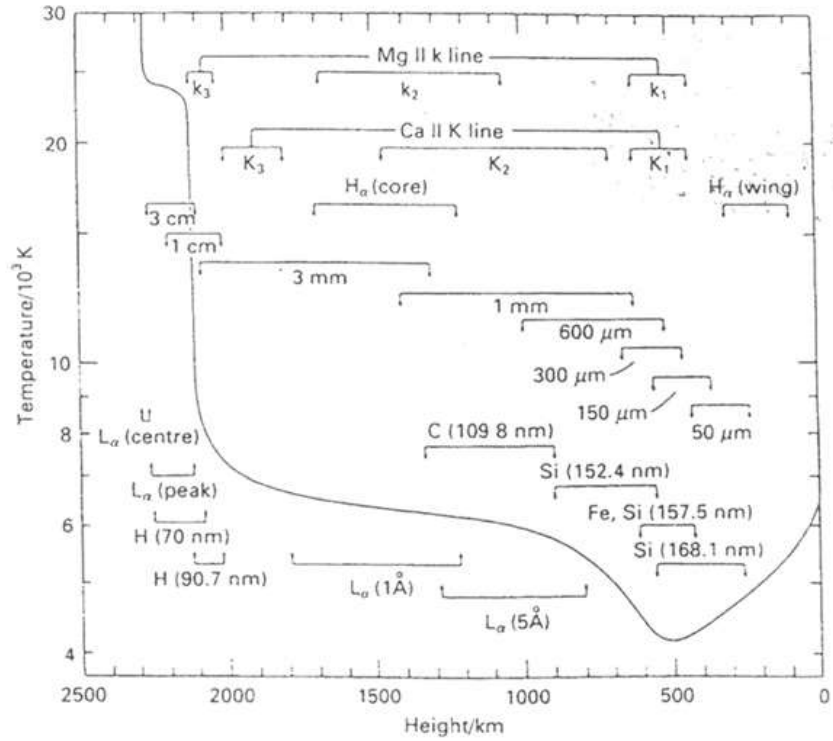

Illustration 9: The altitudes of the transition region for the temperature region being recorded, i.e., between 11.7 GHz and 12.2 GHz, above the photosphere. As there may be differences in polarizations of the transition region during active flares on the sun, these are only estimates as in this Athay Chart, (1986).

## Discussion:

The temperatures resulting from the emission of microwaves at the two frequencies noted above occur at different altitudes in the transition zone separated by a few hundred kilometers. However, depending on the opacity of the Sun's transition zone we are looking at variations of the transition zone's polarizations between these two frequencies, which may change depending upon solar activity such as flares. Where the Cross -Correlations recorded by the Solar Radio may indicate how polarization in these regions (altitudes) of the sun are transferring thermal energy into the corona, we'll only be able to test these hypotheses by analyzing data from a quiet sun through the solar minimum, and comparing these data with other satellite data collected on polarizations between the photosphere and the corona. (Aschwanden, M. J., 2006)

## References

Athay, G. (1986), in *Physics of the Sun*, Vol. 2, edited by P.A. Sturrock *et al.* ( D. Reidel: Dordrecht)

Jansky measures: <https://en.wikipedia.org/wiki/Jansky>

Oxley, P.L., (2007), *Designing a Tunable LO for ELF Measurements*, SARA Proceedings.

Aschwanden, M. J., 2006, *Physics of the Solar Corona*, ISBN 3-540-30765-6 Springer-Verlag Berlin Heidelberg New York

Rose W., K, 1998, *Advanced Stellar Astrophysics*, Cambridge University Press

# Optimizing Antenna-LNA $T_{SYS}$ Performance by Transmission Line Matching

Peter W East

## Abstract

The first rule for amateur radio telescope builders is to maximize sensitivity by connecting the low noise amplifier (LNA) directly to the antenna; maybe via a low-loss band-defining filter. However, this is not always the best strategy, especially if the antenna and/or the LNA impedances are not well matched and even moderately reactive [1]. In Reference 1, it is shown that resistive mismatches are responsible for added thermal noise and that reactive mismatches reduce the available power. In these cases, the professional solution is to design a specific matching circuit. A simpler alternative for amateurs is to use a short length of transmission line as an impedance transformer to improve the antenna-LNA match. The advantages of matching, include maximizing power transfer from the antenna to the LNA and also minimizing resistive mismatch noise - a double whammy improvement! With available cheap Vector Network/Antenna Analyzers (VNA), amateurs can easily measure RF component complex impedances to underpin transmission line length calculation.

## Introduction

Maximum power is transferred from a matched antenna to a following LNA when the LNA load resistance is equal to that of the antenna. When the source and load are unmatched but purely resistive, there is a mismatch power loss which both attenuates the wanted signal and in addition produces extra thermal noise. With reactive source and load components, the presence of the reactance reduces the load current, which in turn reduces the available power to the LNA, but generates no extra noise. With combined resistive and reactive source and load components, the result is less predictable, producing both mismatch loss and reduction in available power. An example in Reference 1 showed that by improving the match in a practical case by using a quarter-wave transmission line transformer, the resistive mismatch noise was much improved. This article explores the use of a calculated length of transmission line between the antenna and LNA, acting as an impedance transformer, in an attempt to optimize the RF path match and improve the system noise temperature  $T_{SYS}$ . A Python computer program using the transmission line equations is appended; by inserting measured system impedance values and running the program in a Python integrated development environment (IDE), it outputs data and graphical plots from which the optimum transmission line length can be chosen to minimize the system  $T_{SYS}$ . The line insertion loss is small as its electrical length is invariably less than half a wavelength at the design center frequency.

## The Problem



Figure 1. Attenuation and Mismatch (Return Loss) Contribution to  $T_{sys}$  Noise Temperature

Typical radiometer antennas and LNAs will have match specifications with voltage standing wave ratios (VSWRs) in the region 1.5 to 2.0 when measured in a 50 ohm transmission line. The corresponding return loss range is -14dB to -9.5dB.

Figure 1 shows that with even modest attenuation or mismatch system specifications, these losses can have quite a large effect on the system noise temperature  $T_{SYS}$ .

The standard form of the radiometer system noise equation is,

$$T_{SYS} = A(1 - \rho^2)T_S + [1 - A(1 - \rho^2)]T_a + T_{LNA} \quad (1)$$

Where,  $A$  is the antenna-LNA connection power loss factor (connector attenuation) and  $\rho$  is the voltage reflection coefficient at the antenna terminal ( $\rho = |(z_S - z_L)/(z_S + z_L)|$ , where  $z_S$  and  $z_L$  are the source and load impedances).  $\rho^2$  is a measure of the return loss ( $10 \cdot \log(\rho^2)$ , in dB).  $T_{LNA}$  is the LNA noise temperature and  $T_a$  is the ambient temperature (= 290 °K)

Equation 1 implies that both signal attenuation and mismatch noise increase with junction mismatch and attempts to improve the RF chain match to reduce  $\rho$  could pay dividends.

This equation is strictly only true if neither the antenna nor the LNA have any reactance components. The equation modification where there are significant reactance components is analyzed in the following sections culminating in a modified  $T_{SYS}$  formula, Equation 6.

## RF Analysis

### a) Direct Antenna-LNA Connection

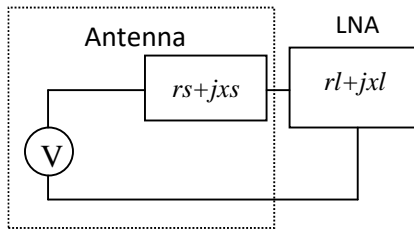

Figure 2. Antenna-LNA Direct connection

From Figure 2, for direct antenna-LNA connection and with the antenna complex source impedance,  $z_S = rs + jxs$  and LNA complex load impedance  $z_L = rl + jxl$ , the power absorbed by the load resistance component, calculated using basic circuit theory, is given by [2],

$$P_{rl} = \frac{V^2 rl}{(rs + rl)^2 + (xs + xl)^2} \quad (2)$$

and the maximum available power with reactance occurs when,

$$rl^2 = rs^2 + (xs + xl)^2, \text{ so that the available power now is,}$$



$$P_{availX} = \frac{V^2 \sqrt{rs^2 + (xs + xl)^2}}{\left( rs + \sqrt{rs^2 + (xs + xl)^2} \right)^2 + (xs + xl)^2} \quad (3)$$

The ratio of the power absorbed by the load resistance to the maximum available power with zero reactance is the attenuation loss factor,

$$A_{Mloss} = \frac{4 rl rs}{(rs + rl)^2 + (xs + xl)^2} \quad (4)$$

This is equivalent to the transmission line power ratio,  $1 - |\rho|^2$ , where  $\rho$  is the complex voltage reflection coefficient. It includes the resistive mismatch loss and the available power loss due to the reactance.

The ratio of the power absorbed by the load resistance to the available power with reactance is a measure of the circuit resistive mismatch attenuation loss factor and is given by,

$$\frac{P_{rl}}{P_{availX}} = A_{rlX} = \frac{2 rl \left( rs + \sqrt{rs^2 + (xs + xl)^2} \right)}{(rs + rl)^2 + (xs + xl)^2} \quad (5)$$

The effect of reactance components in the source and load is summarized in Figure 3.

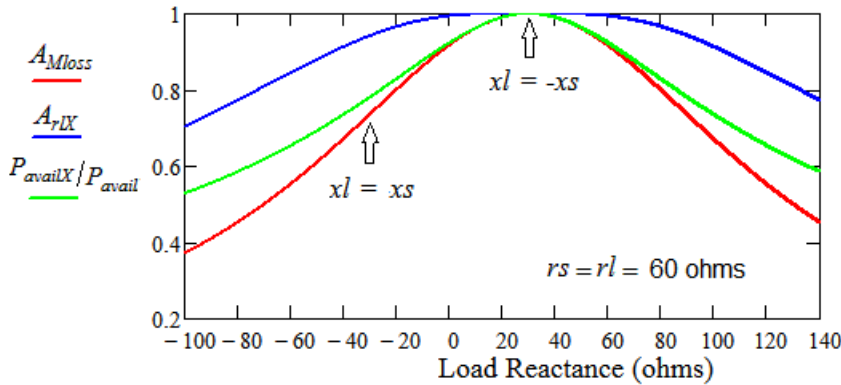

**Figure 3.** Loss v Load Reactance; Total loss (red), Available Power (green), Resistive Mismatch Loss (blue)

Figure 3 is derived from Equations 3, 4 and 5 and plotted as a function of the load reactance. For this example, the antenna impedance is,  $60 - j30 \Omega$  and the LNA impedance given by  $60 + jxl \Omega$ , where  $xl$  is varied over Figure 3 x-axis range. It shows that unbalanced source and load reactance (away from  $xl = -xs$ ), reduces the available power for the load and indicates the reactive portion of return loss (Equation 5) that does not contribute to the system noise.

Note that the red curve is equivalent to the transmission line return loss measure and that the blue curve (resistive mismatch) and the green curve (available power loss due to reactance) represent its real and reactance components. In this example, with equal resistive components, optimum match occurs when the reactive components cancel and clearly demonstrates that large reactance unbalance is to be avoided.

Using the information from this section, by separating the complex impedance loss factor components,  $T_{SYS}$  of Equation 1 modifies to,

$$T_{SYS} = A.A_{Mloss}.T_S + [1 - A.A_{rIX}]T_a + T_{LNA} \quad (6)$$

In practice, there are other noise sources collected by the antenna including, sky noise,  $T_{sky}$ , cosmic microwave background,  $T_{CMB}$ , and spillover/side or back-lobe noise,  $T_{spill}$  that also contribute to  $T_{SYS}$ . These are in turn attenuated with the wanted signal  $T_S$  by the loss factors:  $A.A_{Mloss}$

An indicative measure of the working target signal-to-noise ratio (SNR) is,

$$SNR = \frac{A.A_{Mloss}.T_S}{(1 - A.A_{rIX})T_a + T_{LNA} + A.A_{Mloss}(T_{sky} + T_{CMB} + T_{spill})} \quad (7)$$

#### b) Transmission Line Antenna-LNA Connection

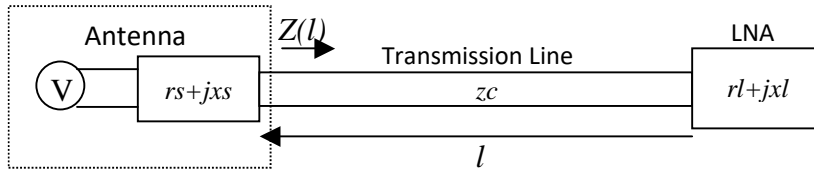

**Figure 4.** Antenna-LNA Transmission Line Connection

Inserting a loss-less transmission line, length  $l$ , characteristic impedance  $zc$  terminated by a load  $zl$ , the line input impedance (Figure 4), is given by,

$$Z(l) = zc \left[ \frac{\frac{zl + zc}{2} e^{j\frac{2\pi fl}{c}} + \frac{zl - zc}{2} e^{-j\frac{2\pi fl}{c}}}{\frac{zl + zc}{2} e^{j\frac{2\pi fl}{c}} - \frac{zl - zc}{2} e^{-j\frac{2\pi fl}{c}}} \right] \quad (8)$$

where,  $zl = rl + jxl$

and,  $f$  is the signal frequency

The voltage and current along the line length  $l$ , measured from the load is given by,

$$V(l) = il \left[ \frac{zl + zc}{2} e^{j\frac{2\pi fl}{c}} + \frac{zl - zc}{2} e^{-j\frac{2\pi fl}{c}} \right] \quad (9)$$

$$I(l) = \frac{il}{zc} \left[ \frac{zl + zc}{2} e^{j\frac{2\pi fl}{c}} - \frac{zl - zc}{2} e^{-j\frac{2\pi fl}{c}} \right] \quad (10)$$

$V(l)$ , describes the voltage standing wave and the load current  $il$  is given by,

$$i_l = \frac{Z(l)}{z_s + Z(l)} \left[ \frac{1}{\frac{z_l + z_c}{2} e^{j\frac{2\pi fl}{c}} + \frac{z_l - z_c}{2} e^{-j\frac{2\pi fl}{c}}} \right] \quad (11)$$

where,  $z_s = r_s + jx_s$

The available power with reactance terms (Equation 3) now becomes,

$$P_{availX} = \frac{V^2 \sqrt{r_s^2 + [x_s + \text{Im}(Z(l))]^2}}{\left( r_s + \sqrt{r_s^2 + [x_s + \text{Im}(Z(l))]^2} \right)^2 + [x_s + \text{Im}(Z(l))]^2} \quad (12)$$

Equations 4 and 5 are similarly modified with  $r/l$  and  $x/l$  replaced by the real part of  $Z(l)$ , ( $\text{Re}(Z(l))$ ) and the imaginary (reactance) part of  $Z(l)$ , ( $\text{Im}(Z(l))$ ), respectively.

A property of a transmission line loaded with a complex impedance is that both the input impedance magnitude and vector argument (phase) varies as a function of the transmission line length and tuning the length for best match provides a useful alternative to bespoke matching circuits.

### Application

Traditionally, understanding reflections at microwave junctions and optimizing microwave circuit performance with matching circuits uses the Smith Chart but for this article a Python 3 program (see Appendix) has been written exploiting the transmission line equations above to facilitate evaluation and optimizing the antenna - LNA match. For antenna complex impedance values, either a Vector Network Analyzer or the Vector Antenna Analyzer (Figure 5) are suitable.



Figure 5. Vector Antenna Analyzer Type: N1201SA

The test example offered in Reference 1 is repeated here, but instead of using the case of applying a quarter-wave transformer, the analysis considers the response for arbitrary lengths of intermediate transmission line up to half a wavelength.

**Reference 1 Example:  $T_{SYS}$  Noise Calculations with Intermediate Transmission line.**

For this example, consider using an LNA with 0.4 dB noise figure (with an input VSWR of 1.8 at 50  $\Omega$  characteristic impedance, connected to the antenna with a connector loss of 0.2 dB. The Mini-Circuits ZX60P33U LNA input impedance at 600 MHz is,  $30.8 - j13.5 \Omega$ . The antenna measured VSWR is 1.5 and the antenna source impedance is  $62.5 + j20 \Omega$ . The ambient temperature,  $T_a$  is assumed to be 290° K.

In this case, analyze the system with an arbitrary length transmission line up to half a wavelength.

Before the Python analysis program *matchplot.py* (see Appendix) is run, it is user-initialized by changing the default parameters in lines 17 to 24. These are currently set to the above example figures.

```
Spyder matchplot.py; Input data - ADJUST IN PROGRAM TO SUIT
zc = 50                ## Line characteristic impedance (ohms)
zl = 31.8 - 1j*13.5   ## Source (antenna) impedance (ohms)
zs = 62.5 + 1j*20     ## Load (LNA) impedance (ohms)
f = 600000000         ## Radiometer center frequency (Hz)
Atten_dB = 0.2        ## RF chain attenuation/loss (dB)
LNA_dB = 0.4          ## LNA noise figure (dB)
Tsky = 15             ## Sky temperature
Tspill = 20           ## Spillover or side/backlobe temperature
```

Running the program in the *Spyder IDE* with these figures, the graphical output is shown in Figure 6.

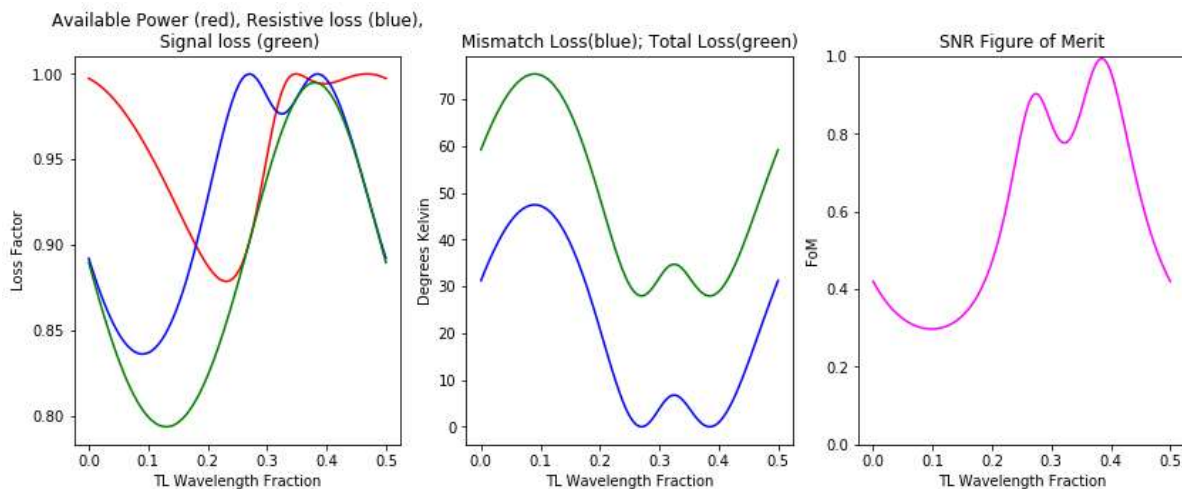

**Figure 6.** Example Results: Power Loss Factors and Resistive Noise Temperature

In Figure 6, the x-axis plots the transmission line electrical length over the range 0 to half a wavelength. Note the x-axis zero corresponds to direct antenna-LNA connection.

*Notes:*

In the left hand plot, the **red** curve records the available power from the antenna including the path attenuation as a ratio of the maximum, occurring when the source and load resistances are equal and the reactance parts cancel (Equation 2).

The **blue** plot indicates the mismatch real power loss factor from which the resistive noise temperature can be calculated.

The product of the available power and the resistive mismatch loss factors indicate the expected signal attenuation factor (**green**) due to the total mismatch return loss.

In the center plot, the **blue** curve indicates the resistive mismatch noise temperature in  $T_{SYS}$  and clearly indicates that a transmission line of 0.27 or 0.38 wavelengths will optimize the system performance. The **green** curve indicates the total noise temperature level, including the LNA, and contributions from the antenna-LNA attenuation, plus sky, CMB and spillover/sidelob/backlobe noise estimates.

The right hand **magenta** plot displays an SNR figure of merit (FoM) plot which indicates the advantage of the optimum transmission line of 0.38 times the signal wavelength over direct antenna LNA connection (equivalent to the measure at the zero length ordinate).

The FoM is defined as the SNR from Equation 7 divided by the SNR with no mismatch loss, i.e with  $A_{Mloss} = 1$  in Equations 6 and 7. So at 0.38 x wavelength the antenna-LNA are fully matched in this example (only the physical loss  $A$  and its noise contribution remain) and the fully matched  $T_{SYS}$  (Equation 6) becomes,

$$T_{SYS} = A(T_S + T_{sky} + T_{CMB} + T_{Spill}) + [1 - A]T_a + T_{LNA} \quad (13)$$

It is interesting to note from Figure 6, that the original guess of a quarter-wave transformer line, fortuitously found a region of improved performance.

Referring back to the **red**, **green** and **blue** curves in the first plot, with 0.38 wavelengths of 50  $\Omega$  transmission line between the antenna and LNA, the overall  $T_{SYS}$  performance will ensure the maximum available source power and virtually zero resistive mismatch noise.

*Spyder matchplot.py; Output Data:*

Input Data:

zc= 50 zs= (62.5+20j) zl= (31.8-13.5j) f= 600.0 MHz

loss= 0.2 dB, LNA\_noise = 27.978 deg K

Tsky etc: = 15.0 deg K, Tspill = 20.0 deg K.

The finer version of Table 1 (with user variable N=50 data increments, output by the program) and the Figure 6 plots indicate that optimum performance and minimum resistive mismatch noise, equivalent to an added noise temperature of <0.1 °K, occurs when the transmission line length is 0.38 wavelengths long and 95% of the available power from the antenna is passed to the LNA including the connection attenuation loss.

The transmission line cable's actual physical length depends upon the cable choice velocity factor.

For comparison, with direct antenna-LNA connection (line length = zero) the resistive mismatch noise adds >32 °K to  $T_{Sys}$ .

TL Length /Lambda	Mismatch Temp:	Available Power Ratio	Return Loss Factor	Figure of Merit
0.0	31.266	0.952	0.849	0.658
0.049	43.945	0.937	0.795	0.559
0.099	47.265	0.912	0.763	0.527
0.149	39.291	0.879	0.76	0.563
0.199	20.993	0.848	0.786	0.692
0.249	2.333	0.843	0.836	0.899
0.299	3.849	0.909	0.897	0.918
0.349	4.056	0.954	0.941	0.942
0.399	0.913	0.949	0.946	0.983
0.449	13.804	0.954	0.908	0.823

**Table 1.** Optimum Transmission Line Length Search Summary (N=10)

**Short Cut**

With the aid of a plotting math package, the optimum line lengths can be found quickly by referring to the derivation of Equation 3, where from differentiating Equation 2, the maximum available power with reactance occurs when:

$$rl^2 = rs^2 + (xs + xl)^2 \tag{14}$$

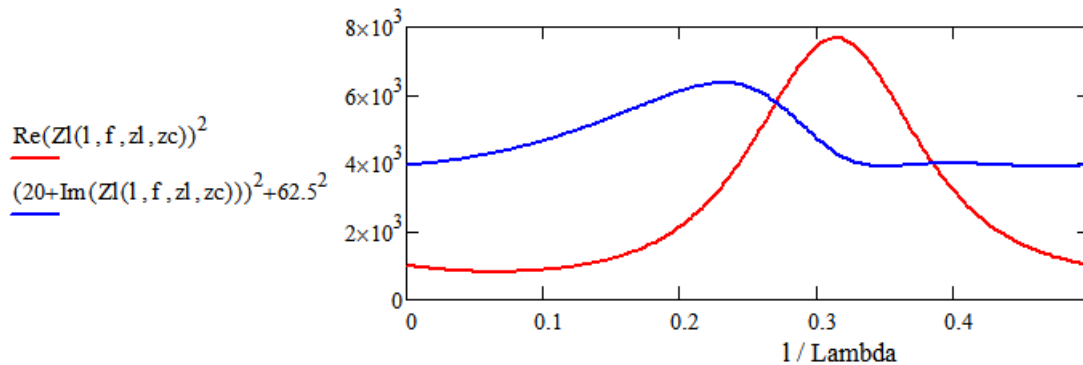

**Figure 7.** Confirmation of Optimum Transmission Line Lengths.

With the transmission line inserted between the antenna and LNA, the transmission line LNA load  $rl$  becomes  $Re(Z(l))$  and the reactive load  $xl$  at the transmission line input becomes  $Im(Z(l))$ . Plotting Equation 14 equality in Figure 7, where they cross confirms the optimum peak lengths noted in Figure 6. The source antenna impedance is  $62.5 + j20 \Omega$ . The crossing points are at  $1/\text{Lambda} = 0.27$  and  $0.38$ ; ( $\text{Lambda}$  is the wavelength at the band center frequency).

Unfortunately, this simple short-cut does not identify which of the two is the best line length.

Figure 7 indicates that the line resistive and reactance components vary over a wide range as a function of line length and it is this property that improves the probability of matching/balancing the corresponding components of the antenna.

## Practicalities

There are a few practical considerations in implementing this  $T_{SYS}$  optimization method, apart from developing the skill to terminate correctly the required length of RF cable.

1. Not all VNAs provide the impedance information as required here - some reminders on typical measures and transformations...

a). *Magnitude + phase*:  $Z \angle \phi : \rightarrow r + jx = Z \cdot \cos(\phi) + jZ \cdot \sin(\phi)$ ;

b). *Magnitude + Inductance/Capacitance*:  $x_L = 2\pi f L$ ;  $x_C = -1/(2\pi f C)$ ;  $\phi = \arcsin(x/Z)$ ;  $r = Z \cos(\phi)$

c). *Complex S-parameter*,  $S_{11} = s_{real} + js_{imag}$ ;  $Z_{in} = Z_C(1 - S_{11})/(1 + S_{11})$ ;  $Z_C$  is line characteristic impedance (50  $\Omega$ ).

The complex division is best done with a math package, but if not available, here is the long-hand version: -

$$\left( \frac{a + jb}{c + jd} = \frac{ac + bd}{c^2 + d^2} + j \frac{bc - ad}{c^2 + d^2} \right).$$

2. For antenna impedance measurement, it is best to point the antenna to the sky and measure a few points over the operating bandwidth.

3. For LNA input impedance measurements, the recommendation is to use an attenuator (at least 10 dB to lower the VNA input power to avoid over driving. Most VNAs will need recalibration. For some suppliers, Minicircuits for example, they will have detailed input impedance information for their products available on their website.

4. Failing all these complications, a handy alternative is to make up a few odd lengths of cable up to half a wavelength and use the Y-factor  $T_{SYS}$  measurement method to determine the optimum cable length. Fine length adjustment might be possible using a few male and female connectors but beware, unless very high quality, each may have an associated insertion loss.

## Conclusions

The usual advice to connect the LNA directly to the antenna terminal is questionable, as most practical RF components (antennas/filters/LNAs) exhibit complex impedances which can seriously affect the observed system sensitivity unless correctly matched. This article has shown that in situations where it is not possible or feasible to exactly match components or design a specific matching circuit, that by using a length of transmission line as a general purpose impedance transformer, it is possible to choose a line length that optimizes the transfer of power between an antenna and LNA.

Whilst the optimum line length can be obtained by the Python program the length tolerance based on a variety of source/load complex impedance trials, appears variable. As may be the antenna and LNA impedance variation over their operating bandwidths. Usually for very broadband LNAs, the range of complex impedance variation across a narrow band may not be significant but this may not be true for amateur antenna feeds. This therefore needs to be carefully checked.

This technique appears a very worthwhile consideration for amateur radio telescope constructors as it can significantly reduce resistive mismatch noise whilst having little impact on the wanted signal level (compare Equations 1 and 6).

## References

1. East PW, Investigating the Radiometer Tsys Double Whammy Formula, Journal of the Society of Amateur Astronomers, September/October, 2023/

2. Doerry AW, Noise and Noise Figure for Radar Receivers, Sandia National Laboratories Report: SAND2016-9649, October 2016. <https://www.osti.gov/servlets/purl/1562649>

## Appendix: Python Program

This program was developed using the Spyder IDE which is part of the Anaconda software distribution available from: <https://docs.anaconda.com/free/anaconda/install/windows/>

*Although every care has been taken in producing this program it is not guaranteed and its use is entirely at the discretion of the user.*

The following program listing can be 'copied', 'pasted' in Notebook, saved as *matchplot.py* and run in Spyder with user data entered in the program lines 17 to 24. Alternatively, it can be downloaded from:

<http://y1pwe.co.uk/RAProgs/matchplot.py>

Note that complex impedances in Python are written:  $a + 1j*b$  where a and b are the component impedance resistance and reactance numerical values, in ohms.

The output plots are found in the working directory in the file: *Graphs.png*

### matchplot.py Listing:

```
##matchplot.py
"""
author: PWE
Spyder Python 3.7
"""

import matplotlib.pyplot as plt
import numpy as np
import time
timestr=time.strftime("%d %m %Y")
print (timestr)

N = 50    # number of data increments
def rnd(z):    # definition rounds data to 3 dec places
    return float(int(1000*z))/1000

    ## Input data - ADJUST TO SUIT
zc = 50    ## Line characteristic impedance (ohms)
zl = 31.8 - 1j*13.5    ## Source (antenna) impedance (ohms)
zs = 62.5 + 1j*20    ## Load (LNA) impedance (ohms)
f = 600000000    ## Radiometer Centre Frequency (Hz)
Atten_dB = 0.2    ## RF chain loss (dB)
LNA_dB = 0.4    ## LNA noise figure (dB)
Tsky = 15    ## Sky+CMB temperature
Tspill = 20    ## Spillover or Side/backlobe temperature
Tslos = 1-(Tsky + Tspill)/290    # equivalent sky/spill loss factor
A = 10**(-Atten_dB/10)    #attenuation loss factor
Tlna = ((10**(LNA_dB/10)-1)*290)    #LNA equivalent temperature

# Print input data table
print ('\n Input Data:')
print ('zc=',zc,' zs=',zs,' zl=',zl,' f=',f/1000000,'MHz')
print ('loss: = ', rnd(Atten_dB), 'dB, LNA_noise = ', rnd(Tlna), 'deg K')
print ('Tsky etc: = ', rnd(Tsky), 'deg K  Tspill = ', rnd(Tspill), 'deg K \n')
```



```

# Constants:...
c = 299792458      # EM radiation velocity m/s
pi = 3.14159      # Value of pi

b = 2*pi*f/c      # Lossless wave function
lam = c/f         # Signal wavelength (m)
zp = zl + zc      # Mismatch junction impedance sum
zm = zl - zc      # Mismatch junction impedance difference

l = np.linspace(0, lam/2, N)  # length l -axis range (m)

#transmission line calculation definitions
def exl(l):
    return np.exp(1j*(l*b))    # complex exponential definition
def vl(l):                    # line voltage function definition
    return exl(l)*zp/2 + exl(-l)*zm/2
def il(l):
    return (exl(l)*zp/2 - exl(-l)*zm/2)/zc # line current function definition
def Zl(l):
    return vl(l)/il(l)        # Line impedance
def Il(l):
    return Zl(l)/((zs+Zl(l))*vl(l))    # Load current

Pav = 1/4/np.real(zs)      # Available Power with zero reactance

# Next definitions compute available power with reactive source and load
def pa1(l):
    return (abs(np.real(zs) + np.imag(Zl(l) + zs)*1j))
def pa2(l):
    return ((np.real(zs) + abs(np.real(zs) + np.imag(Zl(l) + zs)*1j))**2 + (np.imag(Zl(l) + zs))**2)
def Pavx(l):                # Returns available power
    return (pa1(l)/pa2(l))
def Prl(l):                #LNA load power dissipated
    return ((abs(Il(l)))**2)*np.real(zl)

#Figure of Merit SNR equivalent
def fom(l):                #SNR expected with antenna/LNA reactance
    return ((Prl(l)*A/Pav)/((290*(1-(Prl(l)*A/Pavx(l)))+Tlna + (Tsky+Tspill)*(Prl(l)*A/Pav))))
def fomm(l):              # max SNR with no reactance
    return (A/((290*(1-A)+Tlna+(Tsky+Tspill)*A))) # best SNR no mismatch loss
fomx = max(fom(l)/fomm(l)) # max and min FoM
fomn = min(fom(l)/fomm(l))
def Arlx(l):              # definition computes the complex mismatch + loss
    return (290*(1-(Prl(l)/Pavx(l))))

# plotting 3 2D plots
plt.figure(figsize=(14, 5))
sub1 = plt.subplot(1, 3, 1)
sub2 = plt.subplot(1, 3, 2)
sub3 = plt.subplot(1, 3, 3)

# The plots

```

```

# as a function of the line length between the antenna and LNA
# red - the available power compared to the no reactance case
# blue - resistive mismatches attenuation (noise) factor
# green - the product of the above = normal return loss factor
sub1.plot(l/lam, Pavx(l)*A/Pav, color='red')
sub1.plot(l/lam, Prl(l)*A/Pavx(l), color='blue')
sub1.plot(l/lam, Prl(l)*A/Pav, color='green')
sub2.plot(l/lam, 290*(1-(Prl(l)*A*Tslos/Pavx(l)))+Tlna, color='green')
sub2.plot(l/lam, 290*(1-(Prl(l)/Pavx(l))), color='blue')
sub3.plot(l/lam, (fom(l)/fomm(l)), color='magenta')

# Output data table
print ('Len/Lambda', ' ', 'Mism: Temp:', ' ', 'Avail: Power', ' ', 'Return: Loss', ' ', 'FoM' )
for ss in np.arange(N):
    if (fom(ss*lam/N/2)/fomm(ss*lam/N/2)) > 0*(fomx-(fomx - fomm)/2):
        print (rnd(ss*lam/N), ' ', rnd(Arlx((ss*lam/N/2))), ' ', rnd(Pavx((ss*lam/N/2))*A/Pav), ' ',
        rnd(Prl((ss*lam/N/2))*A/Pav), ' ', rnd(fom((ss*lam/N/2))/fomm((ss*lam/N/2))) )

# naming the axes...
sub1.set_title('Available Power (red), Resistive loss (blue),\n Signal loss (green)')
sub1.set_xlabel('TL Wavelength Fraction')
sub1.set_ylabel('Loss Factor')
sub2.set_title('Mismatch Loss(blue); Total Loss(green)')
sub2.set_xlabel('TL Wavelength Fraction')
sub2.set_ylabel('Degrees Kelvin')
sub3.set_ylim(0, 1)
sub3.set_title('SNR Figure of Merit')
sub3.set_xlabel('TL Wavelength Fraction')
sub3.set_ylabel('FoM')
plt.savefig('Graphs.png') # graphical plots
plt.show()

```

PWE November 2023



Peter East, [pe@y1pwe.co.uk](mailto:pe@y1pwe.co.uk) is retired from a Defense Electronics career in radar and electronic warfare system design. He has authored a book on Microwave System Design Tools, is a member of the British Astronomical Association since the early '70s and joined SARA in 2013. He has had a lifelong interest in radio astronomy; presently active in amateur detection of pulsars using SDRs, and researching low SNR pulsar recognition and analysis. He has recently written two other books, 'Galactic Hydrogen and Pulsars - an Amateurs Radio Astronomy' and 'An Amateurs Radio Astronomy - Small Aperture Pulsar Detection', both describing his work in Radio Astronomy. He maintains an active RA website at <http://www.y1pwe.co.uk/RAProgs/>

## The Auroral Oval and Auroral Zone

Whitham D. Reeve



Coronal mass ejections (CME) from the Sun on 27 and 28 November, intercepted Earth early on 1 December and caused a severe geomagnetic storm (figure 1). The interaction of the interplanetary magnetic field (IMF) with Earth's magnetic field opened a gap, allowing energetic particles in the solar wind to enter the magnetosphere. These particles rained down on Earth's high-latitude atmosphere where they collided with neutral atoms and molecules and, in the process, produced aurora and radio propagation effects. Events like this provide a good opportunity to discuss the *auroral oval* and *auroral zone*, the subjects of this article. The effects of the 1 December geomagnetic disturbance on radio propagation are published separately.

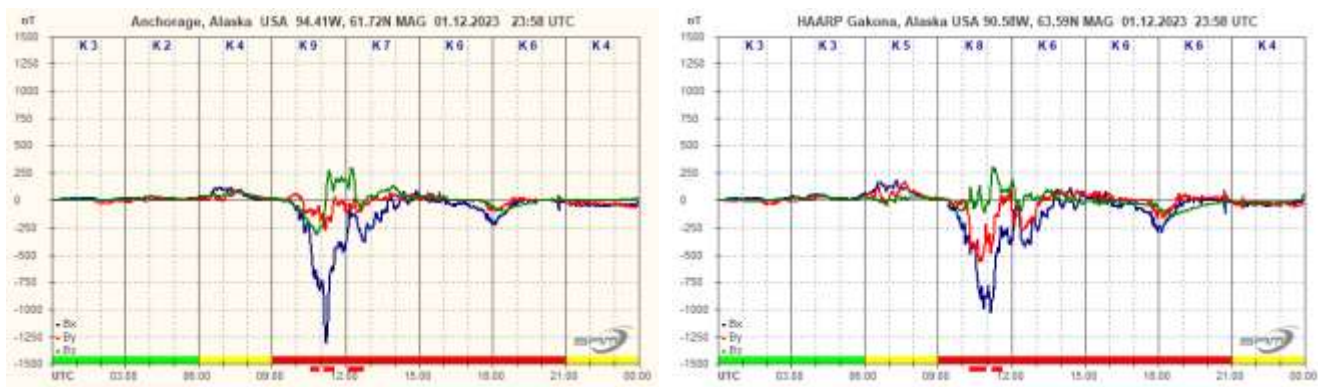

Figure 1 ~ Magnetograms from the SAM-III magnetometers at Anchorage and Gakona, Alaska for the 24-hour period 1 December 2023. The two sites are about 290 km apart and differ in magnetic latitude by about 2° and longitude by about 4°. The CME impact occurred at 0020 UTC and cannot be discerned in the traces because of the high vertical scale. About 6 hours after the sudden impulse, the magnetic field showed a brewing storm and just before 1000 experienced a major disturbance with the K-index going to maximum value (K9).

### Auroral Oval & Auroral Zone

Two concepts are used to discuss where aurora occurs and is observed - the auroral oval and auroral zone. The *auroral oval* is a belt of auroral emission around the north and south geomagnetic poles. The ovals are fixed in space with respect to the Sun, and the Earth rotates below them. The poleward and equatorward boundaries of the auroral ovals depend on conditions in the solar wind including speed, density, and magnetic field orientation as well as conditions in Earth's ionosphere and magnetosphere. The solar wind pushes the ovals toward the nightside of Earth, so they exist at lower latitudes on the nightside than on the dayside. The aurora itself occurs at altitudes of about 100 to 400 km but sometimes as high as 700 km.

When the Sun and its solar wind are quiet (figure 2-left), the auroral ovals shrink and their equatorward boundaries move poleward. Under these conditions, the oval belts are approximately 23° from the geomagnetic poles on the nightside of Earth and 15° from the poles on the dayside. Under these relatively quiet space weather conditions, aurora still occurs but only in a relatively narrow band.

During active conditions the ovals expand in diameter and width such that aurora occurs at much lower latitudes; however, the poleward boundaries do not change much (figure 2-right). The ovals reflect the footprints of closed

geomagnetic field lines at higher latitudes that thread through the Earth's plasma sheet (figure 3). Inside each auroral oval is a *polar cap*, which is threaded by magnetic field lines that are stretched to the magnetotail and are open to the IMF. It is the gap between the closed and open field lines that allows particles from the solar wind to enter the magnetosphere and produce the aurora.

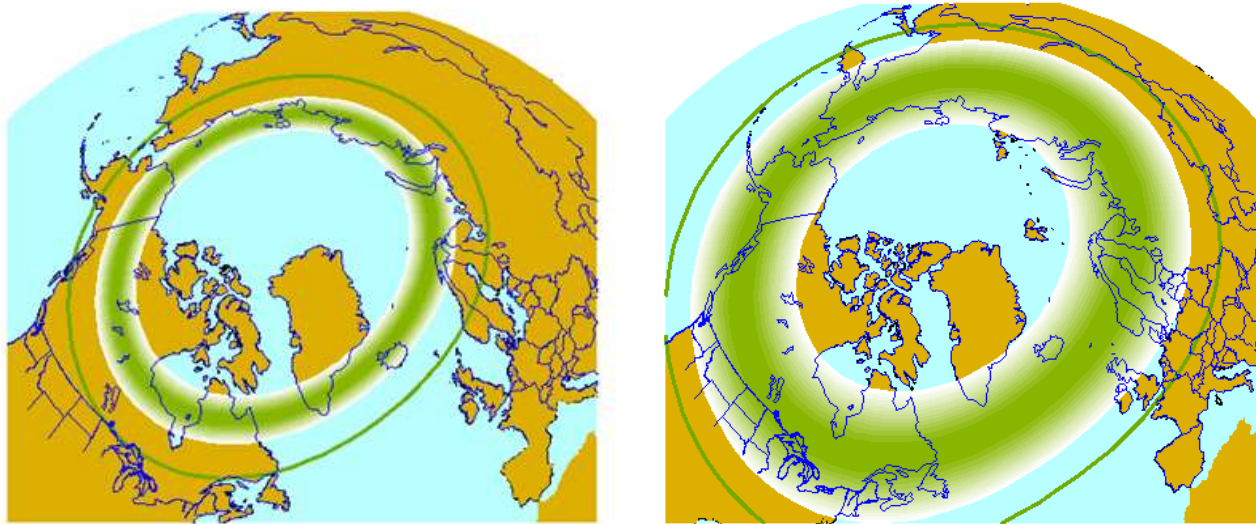

Figure 2 ~ Predictions of the auroral oval and auroral zone in the northern hemisphere. Left: Quiet conditions on 22 September 2023; Right: Comparatively active conditions on 1 December 2023. The wide green belt with white boundaries indicates the predicted auroral oval on the date of the image and the thin green line indicates the approximate boundary for viewing the aurora on the equatorward side of the oval. Note that the poleward boundary of the auroral oval changes very little. Images source: <https://www.gi.alaska.edu/monitors/aurora-forecast>

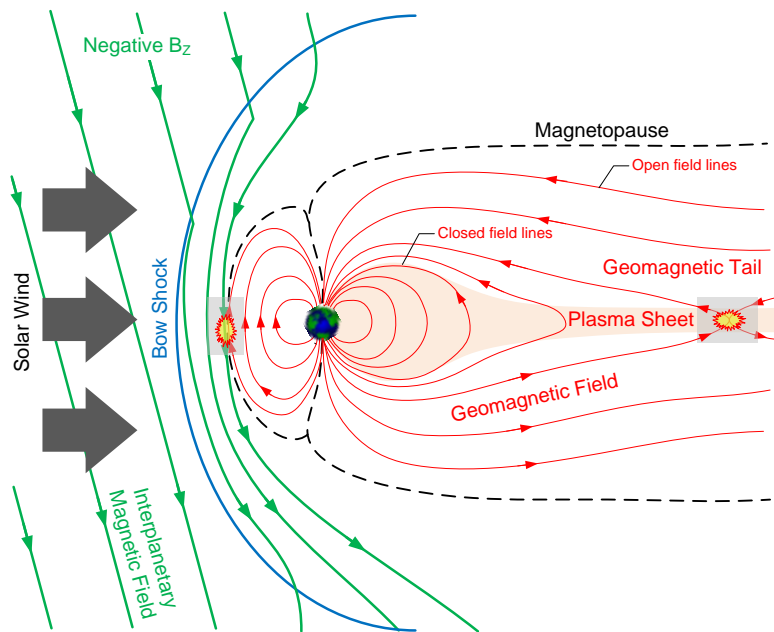

Figure 3 ~ Magnetosphere schematic. The Earth is the circle in the middle and its magnetic field lines are shown in red. The solar wind blows from the left and compresses the magnetosphere on the dayside and stretches it out on the nightside. The IMF is shown in green with a southward component opposite Earth's northward dipole field. Reconnection (red circle on the dayside) opens the geomagnetic field at the magnetopause and allows solar wind particles to enter the magnetosphere. The open field lines fold over into the magnetotail where they eventually close through another reconnection (red circle in the tail). The plasma sheet is a sheet-like region of relatively hot, dense plasma and lower magnetic field in the magnetotail near Earth's equatorial plane.

The *auroral zones* are where the likelihood of seeing nighttime aurora is highest for observers on the ground. As with the auroral oval, there is an auroral zone in each hemisphere, and they similarly expand and contract

depending on solar activity. The difference between auroral ovals and auroral zones is that the ovals are a projection onto the ground, whereas the auroral zones are the locations where aurora may be viewed from the ground. Because of their high altitude, aurora may be viewed some distance from the oval, both poleward and equatorward, so the auroral zone is always somewhat larger than the auroral oval.

The auroral zone is limited by Earth's curvature – if an observer is too far away, the aurora (in the auroral oval) will be below the horizon and out of sight. As a rule of thumb, aurora can be observed 500 km (300 miles) from the oval based on a 20° line-of-sight elevation angle at the observer's location and 225 km altitude for the aurora. Observers farther away than 500 km could see aurora if they have line of sight with an elevation angle below 20° or the aurora is above 225 km altitude. The opposite is true if the observer's location is blocked by mountains or high trees, or the aurora is confined to lower altitudes. And, of course, the sky must be clear between the observer and aurora.

For the geomagnetic storm of 1 December, aurora was reported to be visible in the northern hemisphere as far south as Arizona and California as well as in the southern hemisphere in New Zealand {SpcWx}, indicating that the auroral oval was pushed to at least 40° geographic latitude from its quiet resting place of around 70°.

{SpcWx} <https://spaceweather.com/archive.php?view=1&day=03&month=12&year=2023>

## Radio Propagation Effects of a Severe Geomagnetic Disturbance

Whitham D. Reeve



Earth's magnetic field became severely disturbed on 1 December 2023 after the arrival of multiple coronal mass ejections (CME) that departed the Sun on 27 and 28 November. The collision of the first CME with Earth's magnetosphere produced a sudden impulse that was recorded by the Anchorage SAM-III magnetometer (figure 1). Another CME arrived about 90 minutes later. It had no obvious immediate effect on the geomagnetosphere, but a disturbance was obvious a few hours later. These events involved not only disturbances to the geomagnetic field but also to Earth's ionosphere and HF radio propagation, which are discussed below.

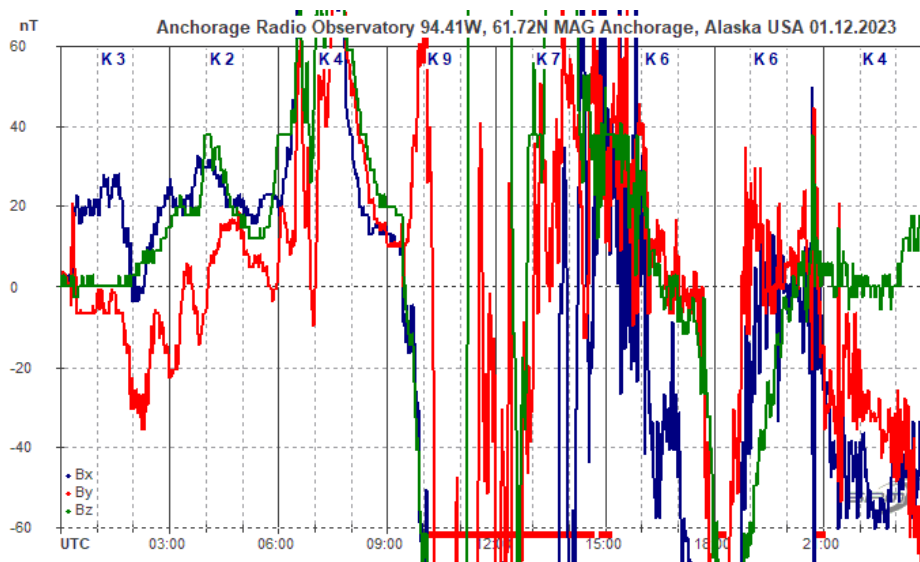

Figure 1 ~ Magnetogram (exaggerated vertical scale) at Anchorage, Alaska showing the sudden impulse at 0020 UTC on 1 December 2023; it is seen as a spike of 21 nT in  $B_y$  (red trace, east-west component) and rapid increase in  $B_x$  (blue trace, north-south component);  $B_z$  (green trace, vertical component) is unchanged until later. Earth's magnetic field did not become significantly disturbed until about 0600 when there was a rapid increase in all three magnetic components. This was followed 3 hours later by another much stronger increase in the  $B_y$  component and decrease in the  $B_x$  and  $B_z$  components. The vertical scale is exaggerated to show the deflection caused by the sudden impulse and this makes the traces of the later disturbances go off-scale.

The radio propagation effects were manifested in the HF radio band as sudden frequency deviations (figure 2) at the time of the sudden impulse and aurora radio reflections (figure 3) considerably later. Sudden frequency deviations (SFD) are caused by rapid electron density changes in the ionosphere, usually by the radiation from a solar flare; however, in this case, the ionosphere likely was compressed, heated and moved by the CME impact, which resulted in a rapid change in the wave number along the radio path. SFDs are discussed in detail in [{Reeve15a}](#) and [{Reeve15b}](#). Auroral radio reflections are caused by increased electron density in the ionosphere's E-region due to increased precipitation and collisions of energetic solar wind particles that enter the magnetosphere and collide with the atmosphere. Aurora radio reflections are discussed in detail in [{Reeve22}](#).

The instrumentation used for these observations was a SAM-III 3-axis magnetometer and three Icom R8600 Communications Receivers. The SAM-III uses its own software, SAM\_VIEW, to collect and display data from each

of three fluxgate sensors setup in the geographic coordinate system. The receivers are connected to a log periodic dipole array about 14 m above ground level. The demodulated audio output from each receiver is connected to a PC soundcard through an analog audio mixer. The receivers are setup to receive the WWV-WWVH time-frequency signals at 15, 20 and 25 MHz. The receivers are tuned with a nominal offset of 1 kHz above the carrier frequencies. With the receivers set to lower sideband (LSB) mode, the demodulated audio output is a nominal 1 kHz tone (each receiver uses a slightly different offset for identification). Argo software processes and displays narrowband waterfall spectra showing the demodulated signals from each receiver.

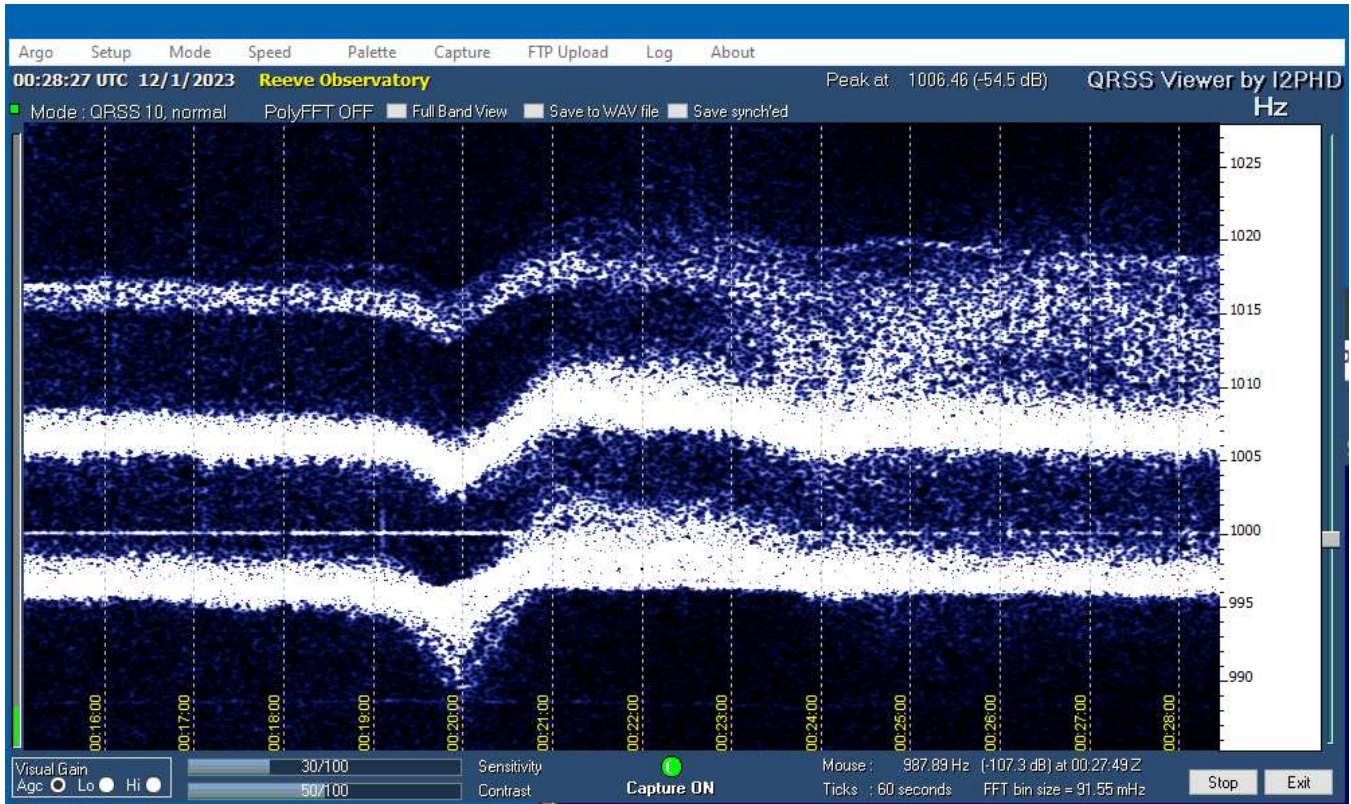

Figure 2 ~ Argo horizontal waterfall plot for 0015 to 0028 UTC on 1 December showing sudden frequency deviations of about 5 Hz at the time of CME impact with Earth’s magnetosphere – the peak deviation was at 0020. The traces for three carrier frequencies are shown: Lower trace, either WWV or WWVH on 15 MHz; Middle trace, WWV on 20 MHz; Upper trace, WWV on 25 MHz. The diffuse nature of the traces is due to the rapid constructive and destructive combining of signals from multiple reflective propagation paths. The faint straight horizontal trace at 1000 Hz is a spurious signal.

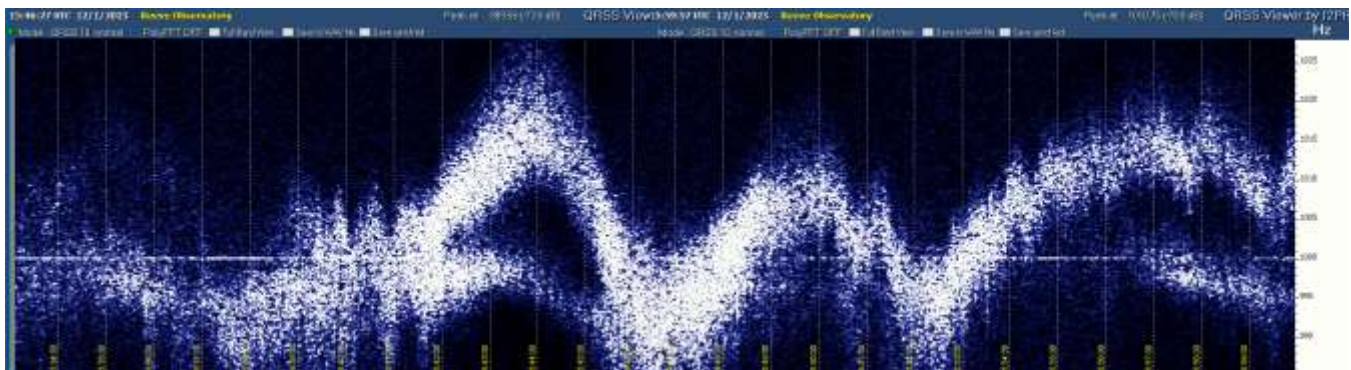

Figure 3 ~ Argo plot for 1534 to 1559 UTC, approximately 15 hours after the sudden frequency deviations above and several hours after the geomagnetic storm was well underway. The plot is two 12-minute Argo images that have been spliced together. The frequency scale on the right is 985 to 1028 Hz. The diffuse traces are the demodulated 15 MHz carrier, probably WWVH, after being reflected by aurora to the antenna and receiver system at Anchorage. Doppler frequency shifts caused by the rapidly moving electron clouds associated with the aurora led to the 25-30 Hz peak-peak quasi-cyclic frequency drift with an approximate period of 6 minutes. The faint straight horizontal trace at 1000 Hz is a spurious signal.

{Reeve15a} Reeve, W., Part I ~ Sudden Frequency Deviations Caused by Solar Flares, Concepts, 2015, download: [https://reeve.com/Documents/Articles%20Papers/Propagation%20Anomalies/Reeve\\_SuddenFreqDevConcepts\\_P1.pdf](https://reeve.com/Documents/Articles%20Papers/Propagation%20Anomalies/Reeve_SuddenFreqDevConcepts_P1.pdf)

{Reeve15b} Reeve, W., Part II ~ Sudden Frequency Deviations Caused by Solar Flares, Instrumentation and Observations, 2015, download: [https://reeve.com/Documents/Articles%20Papers/Propagation%20Anomalies/Reeve\\_SuddenFreqDevMeas\\_P2.pdf](https://reeve.com/Documents/Articles%20Papers/Propagation%20Anomalies/Reeve_SuddenFreqDevMeas_P2.pdf)

{Reeve22} HF Aurora Reflections Observed at Anchorage, Alaska USA, 2022, download: [https://reeve.com/Documents/Articles%20Papers/Reeve\\_AuroraRadioObsrv.pdf](https://reeve.com/Documents/Articles%20Papers/Reeve_AuroraRadioObsrv.pdf)



## Solar Polar field is going to flip: Beginning of Solar 25<sup>th</sup> maxima

Santanu Basu

I am Santanu Basu, amateur solar observer (certified by AAVSO for 1000 observations) and former VLF observer, as well as working in Variable stars research.

### Abstract

This article shows the beginning of solar polar magnetic field flipping and a start of solar 25<sup>th</sup> cycle maxima time, using the polar magnetic data of WSO from 1976 to 2020 and the SDO data from 2010 to 2023 and visual observation data of SILSO observatory from 1976 to 2023. I am using the R statistic code libraries (R, 2023) to show a spline fit of SILSO SSN visual and WSO magnetic data to notice the Solar polar field. The results show polar magnetic field started solar polar magnetic polarity reversal process somewhere from the middle of September 2023, and the process is continuing now, thru 2024 and will influence the peak of Solar Cycle 25.

### Introduction

The first observation of sunspots takes place from 1610, by Galileo. After his study of sunspots and identifying the 11-year cycle, known as Schwabe cycle ([Schwabe, 1844](#)) is important for us for knowing the sun and its magnetic field. In 1913 Hale was first reported about observed weak general magnetic field of the Sun with opposite polarity in the N- and S-hemispheres [Hale \(1913\)](#).

### Data

The visual SSN data comes from Solar Index and Long-Term Solar Observation (SILSO) <https://www.sidc.be/SILSO/home> from 1976 to October 2023.

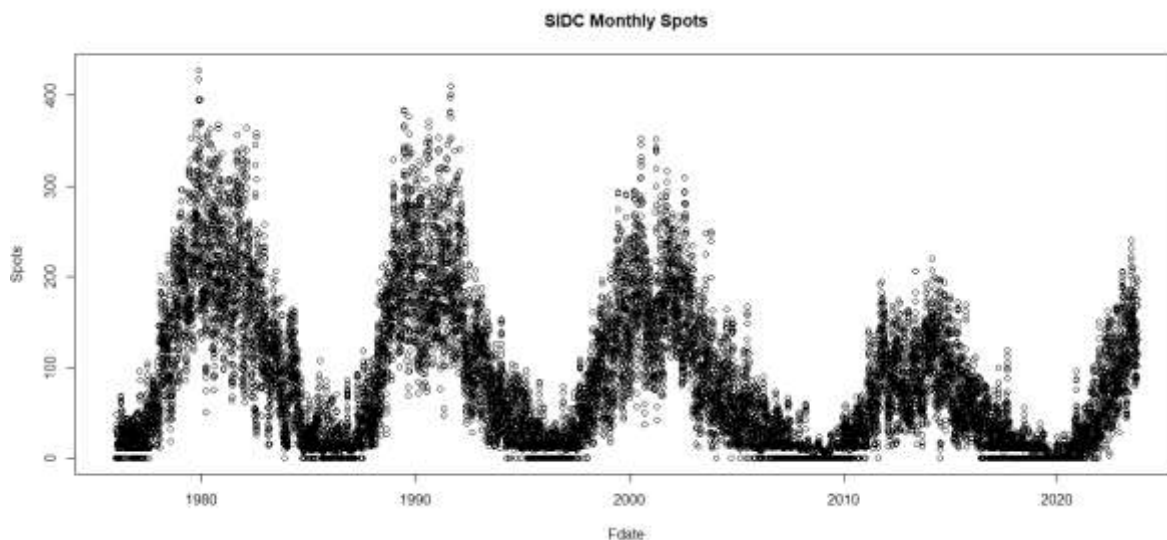

Figure 1 shows the SSN cycle from 1976 to 2023

WSO mean magnetic field data comes from Wilcox Solar Observatory (WSO) <http://wso.stanford.edu/> began to collecting daily observations of the Sun's global (or mean) magnetic field since 1976; I am using the data from 1976 to 2020 and the SDO magnetic data from 2010 to October 2023.

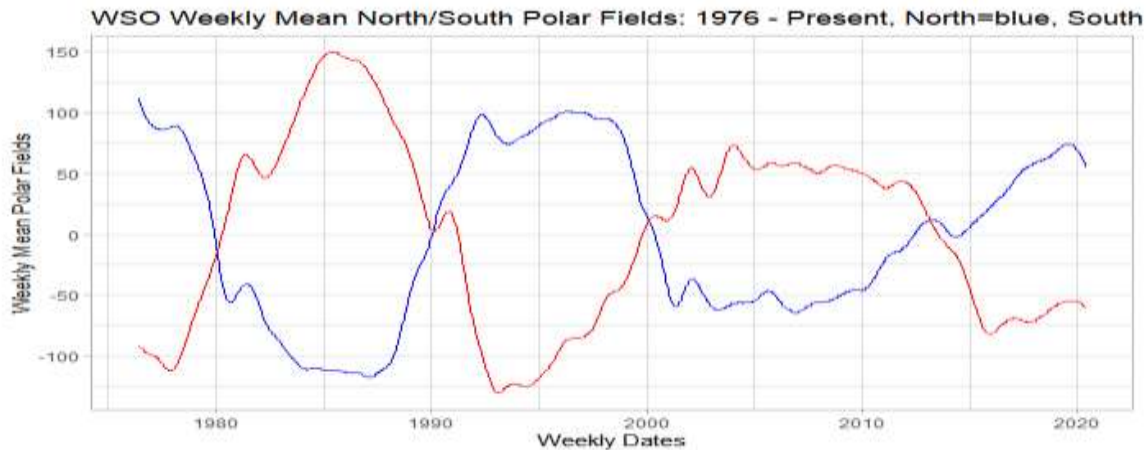

Figure 2 shows the WSO solar magnetic cycles from 1976 to 2020.

### Methods

The WSO polar magnetic field data shows how solar polar fields flip north to south and south to north, the WSO polar fields past record shows when the polar fields are starting to merge and the maxima is going to start, Figure 2. The time of merging of magnetic polar field is approx. 1980,1990,2000,2014 and the SSN peak gets in 1980-81, 1989-91, 2000-02, and 2013-15. Figure 1, more recently Figure 3 shows the SDO data as flipping from October 2023, and suggests the next maxima of 25<sup>th</sup> solar cycle is going to start, and it will be peak from somewhere between the middle or the end of 2024.

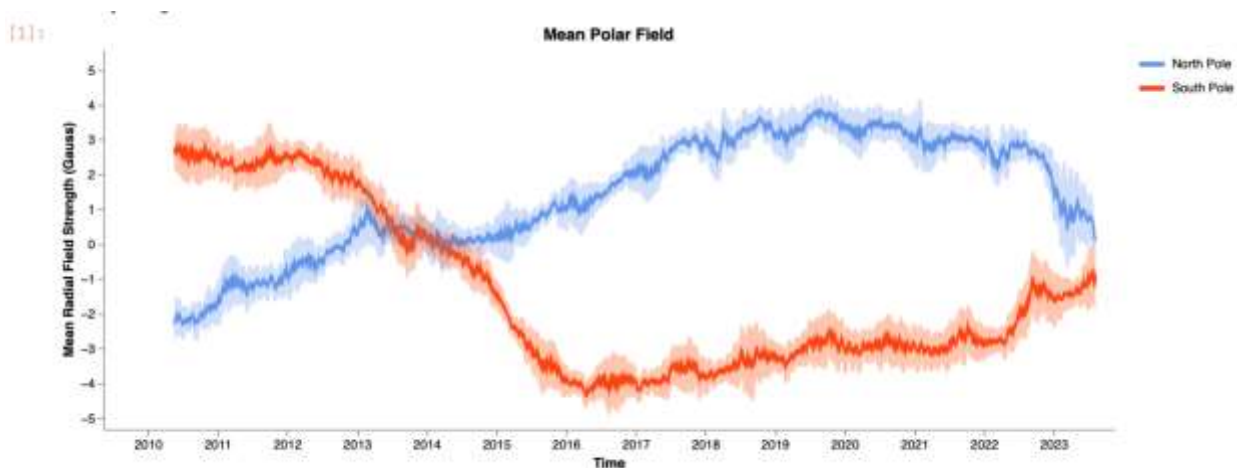

Figure 3 SDO data shows the current solar magnetic field flip beginning in October 2023.

The SDO graph (Figure 3) shows the polarity cross over procedure was in process of two years from 2013 to 2015 in previous cycle 24. The SDO data now shows the solar polarity fields are again crossing over for the current peak of Cycle 25.

### Results

In this article we also investigate the solar polar field which is start flipping and is an indication of the next solar maxima. I am using the R to show the spline of SIDC SSN. R is 'GNU S', a free and open-source statistical computing and graphics language that offers a broad range of statistical and graphical tools: also using R studios to get generate the mean magnetic polar field of the WSO from 1976 to 2020. R Studio is an integrated development

environment (IDE) for R. For plotting the SDO data I am using the mini-conda Jupyter notebook to get SDO mean polar field data, from [https://nbviewer.org/github/mbobra/plotting-polar-field/blob/master/plot\\_polarfield\\_d3.ipynb](https://nbviewer.org/github/mbobra/plotting-polar-field/blob/master/plot_polarfield_d3.ipynb) and I import the SIDC data from [http://sidc.be/silso/DATA/SN\\_d\\_tot\\_V2.0.csv](http://sidc.be/silso/DATA/SN_d_tot_V2.0.csv) using the R libraries, to get the SSN solar cycle plots (Figure 1) for the same time period as the WSO data.

## References

Hale, G. E. AJ, vol. 38, p.27 *Preliminary Results of an Attempt to Detect the General Magnetic Field of the Sun* ([Micola I 2019](#))

“Polar magnetic fields of the Sun influence solar activity minima and minimum. There are some difficulties in observation of the polar fields because they are observed from the Earth at large projection angle, and, moreover, the Sun’s northern and southern poles are invisible during some period due to the 7.25° inclination of the Earth’s orbit to the plane of the solar equator. To the same, the polar fields are in general significantly weaker than magnetic fields of sunspots and other active features on the middle and low latitudes.”

Mykola I. P Springer 2019, vol 294 A.N 137, *On Polar Magnetic Field Reversal in Solar Cycle 21,22,23 and 24*

Schwabe, S.H, 1843, *Astron Nachr.* 20, 283. 1843

R: <https://www.r-project.org/about.html>

RStudio : <https://www.geeksforgeeks.org/introduction-to-r-studio/>

# A water maser flaring event in the W51 star forming region

---

Eduard Mol

## Introduction and background

Astrophysical masers- the naturally occurring microwave equivalent of lasers- are commonly found in star forming regions and around red giant stars [1]. Masers are narrow-band, bright and point-like sources, and the microwaves they emit easily pass through dense gas and dust clouds. For these reasons, masers provide an excellent tool to study the dynamics of gas deep inside star forming regions [1, 2].

Westerhout 51 is a massive star forming region, based on parallax measurements its distance has been estimated at  $5.3 \pm 0.4$  kiloparsec ( $\sim 17000$  lightyears) [3]. The W51 complex hosts a number of active star-forming sites where maser emission has been observed [3, 4]. In October 2021, a flaring event was reported in W51 at the 22.2 GHz water maser line [5]. This flare reached a remarkably high maximum flux density of 140.000 Jansky in January- February 2022 [6].

Around the same time, I just finished my 1 metre dish setup for detecting water masers at 22.2 GHz. A description of this setup and some earlier observations was published in the August 2022 SARA Journal [7]. W51 was one of the very first targets, and I noted at the time that it seemed unusually bright compared to other maser sources. For about a year W51 was observed every 4- 6 weeks to see if there were changes in its spectrum.

## Data collection and processing

W51 was observed roughly once every 3- 6 weeks between February 2022 and February 2023. During observing sessions spectra were integrated and saved every 60 seconds using the SDR# IF average plugin. Total integration times ranged from 20 to 50 minutes. Off- target spectra for bandpass correction were recorded prior to and/or after recording on-target spectra. Correction for frequency drifting of the LNB was done since June 2022 using a weak, stable pilot tone generated with a GPSDO and recorded during observations. After bandpass correction and frequency correction the individual 60 second spectra were averaged. Note that the first three spectra were recorded before the frequency calibrator was installed, and the reported LSR velocities of those spectra are therefore likely inaccurate.

It would be desirable to estimate flux density, as this is independent of the radio telescope system used and would thus be best for comparison purposes. However, calibrating to flux density would require observation of a standard source like Cygnus A or Taurus A, which are too weak to easily detect with the 1 metre dish at 22.2 GHz. Variations in atmospheric noise further complicates calibration. I have therefore decided to report the spectra “as is” without converting the vertical scale to flux density or even antenna temperature. Note that the output of the IF average plugin is millivolt amplitude rather than power. For comparison purposes the output values have therefore been squared to represent spectral power, which is at least linearly correlated with antenna temperature and flux density via some unknown constants.

### Determination of the system temperature

The system temperature of the 1 metre dish was estimated with the “Y- method” following (eq. 1), using the sky as a cold reference and a nearby brick wall as the hot reference [8, 9].

$$T_{sys} = \frac{T_{hot} - Y \times T_{cold}}{Y - 1} \text{ (eq. 1)}$$

In this equation Y is the ratio between the measured receiver power of the hot and cold sources. For a first- order estimate, the sky at zenith was used as the “cold” reference, while a nearby brick wall was used as the “hot” reference. The wall was assumed to be near ambient temperature (25° C, ~300 K). The cold sky temperature varies at 22.2 GHz with the zenith angle and amount of clouds and water vapour, but is typically ~40 Kelvin near zenith at sea level when the sky is free of clouds [10]. The measured Y- factor was 1.95, filling this in (eq. 1) assuming  $T_{hot} = 300\text{K}$  and  $T_{cold} = 40\text{ K}$  gives us a  $T_{sys}$  of 274 K. However, because the maximum elevation of W51 is about 50° at my location, the actual  $T_{sys}$  during observations was likely somewhat higher.

### Results

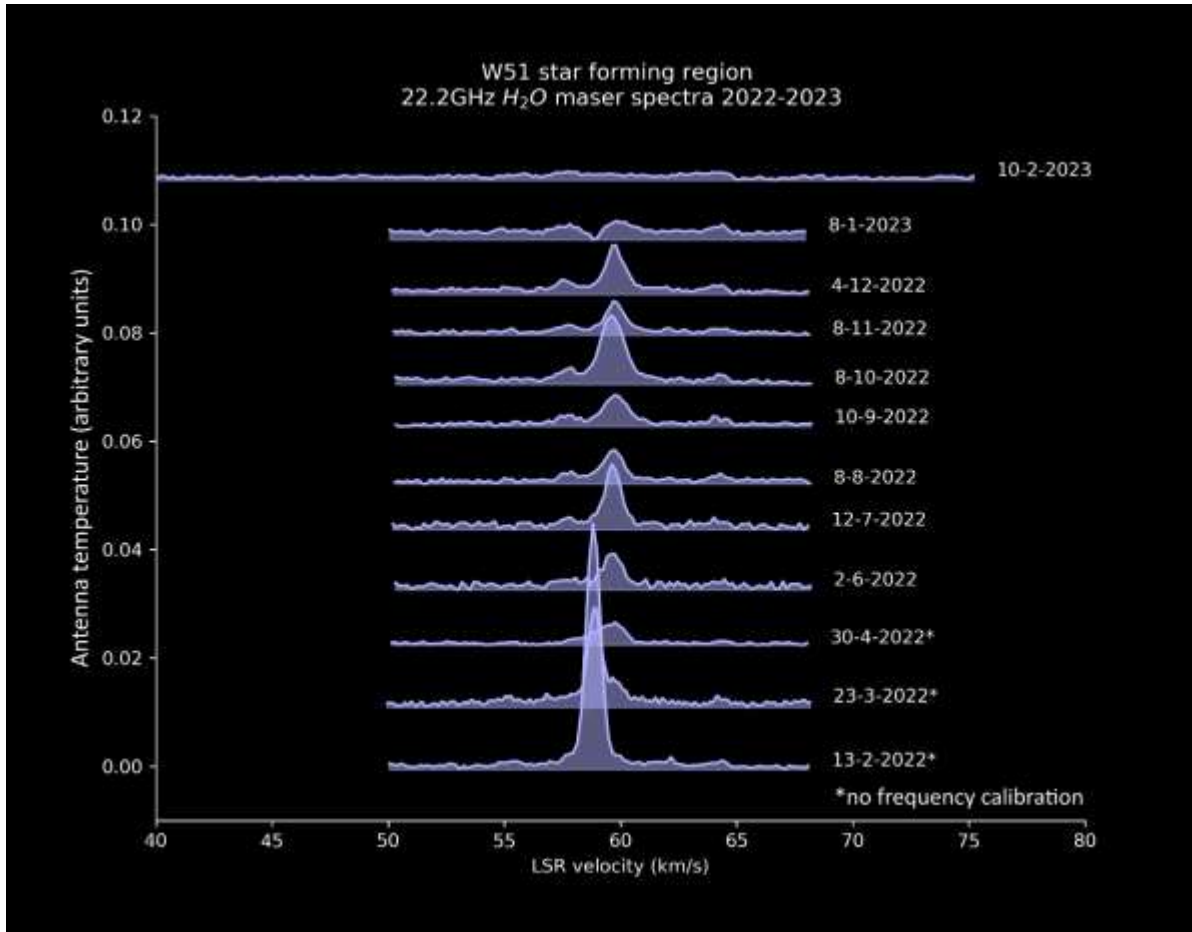

Figure 1: spectra of the 22.2 GHz water maser source in W51. The dates with an asterisk were before the installation of the frequency reference, and the LSR velocities of those spectra therefore have a high uncertainty.:

The maser feature at 59 km/s was very strong during the first observation on February 12 2022, but rapidly decreased by an order of magnitude over the next two months. Some lesser flares of this feature apparently occurred in July and October- December of 2022. Between December 2022 and February

2023, the 59 km/s feature diminished again by an order of magnitude and finally disappeared below the noise floor. Two weaker features at 57 and 64 km/s remained, but because the maser had become much more difficult to detect at this point no further observations were done.

**Comparison with Volvach et al. (2023)**

Recently a paper was published by A. E. Volvach and colleagues about the 2021- 2022 flare in W51 [6]. According to these authors the maser reached a very high peak flux of 140 000 Jy in January- February 2022. My first observation on February 12, 2022, was just after maximum, so mostly the declining phase of the flare was recorded.

For comparison, the peak intensity of the 59 km/s peak in my own spectra was plotted together with the reported flux density (read off from Figure 1 in the paper). The peak intensity was scaled by a factor of 2400 to plot it on the same scale as the reported flux density.

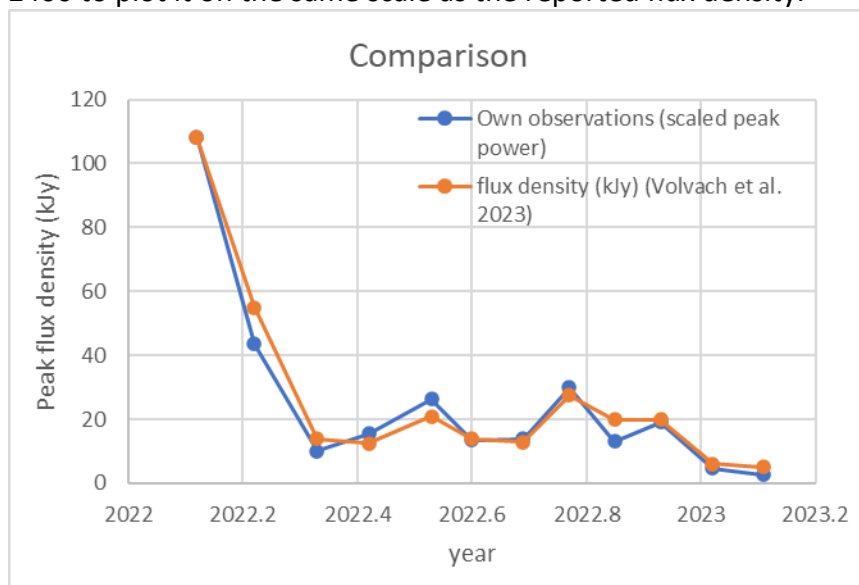

Figure 2: comparison of the measurements from the 1 metre dish with those made by a professional radio observatory

The general pattern is reproduced surprisingly well: in both graphs the main flare decayed rapidly between February and April 2022 and was followed by some weaker flares in August- October 2022, before the maser finally returned to a quiescent state in the early months of 2023. However, there are also points where my own observations clearly deviate. This could likely be attributed to factors such as pointing errors and variations in atmospheric noise and absorption.

Plotting my own measurements against the flux density reported in [6] also shows a good correlation ( $R^2 = 0.986$ ). However, the fact that the flux density varied over two orders of magnitude definitely helped with this. The trendline in this graph will also allow us to make rough flux density estimates for other observed masers.

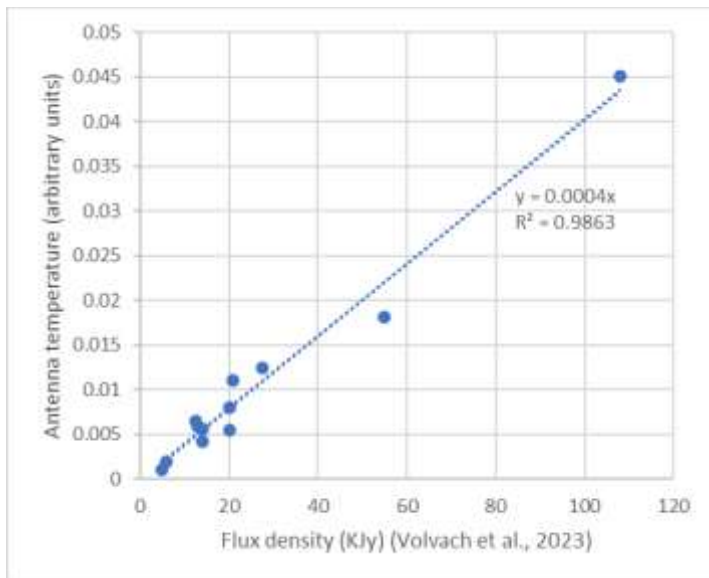

Figure 3: correlation between measurements of the 1 metre dish and reported flux density of the flare.

### Velocity deviation

The LSR velocities calculated from my own spectra (at least those made after the frequency calibration signal was installed in May 2022) have a constant offset of 0.8 km/s with the peak LSR velocity reported in the paper. It is still unclear whether this a small error is introduced by the frequency calibration procedure, the LSR correction, or some other factor.

### Why was there a flaring event?

Now that the measurements of the 1 metre dish have been discussed and compared to results from a professional observatory, we can speculate about the origin of the flare event.

Masers arise from stimulated emission: if a molecule in a higher energy level interacts with an incident photon of exactly the right energy, the molecule can drop to a lower energy level, emitting the excess energy as an additional photon. As long as there is an excess of molecules in the higher energy level - a "population inversion" - along the line of sight, there can be a cascade of such stimulated emission events, resulting in the amplification of microwaves at a very specific wavelength. The population inversion needs to be maintained by some form of a pumping mechanism which constantly raises the molecules back into the higher energy level. This "pumping" of molecules to higher energy levels usually occurs via absorption of higher energy photons (radiative pumping) or collisions between molecules (collisional pumping). As long as the pumping rate is higher than the rate of (stimulated) emission, the maser is unsaturated - an increase in the number of incident photons will be amplified to an exponentially larger increase of the maser brightness. When the rate of stimulated emission reaches the pumping rate the maser is "saturated" and can no longer amplify in this way. [1, 2, 11].

Most hypotheses that aim to explain maser flaring phenomena often invoke three key mechanisms: 1) an increase in the number of incident photons; 2) an increase in the pumping rate; or 3) an increase in the path length (beaming) [11, 12, 13]

### Environment of masers in star forming regions

In order to interpret the flare event in W51 we first need to understand the environment of these masers. This is not an easy task for astronomers because of the very dense and opaque gas clouds in which the masers occur. Much of the information we have about these regions therefore comes from the masers themselves or other radio emissions, which are not hindered by the dense gas and dust VLBI observations of water masers in star forming regions have revealed some clues about the environment they occur in. In VLBI maps it is seen that the masers typically occur in dense clusters of so-called maser spots. These are dense cloudlets where the conditions are right for maser emission to occur. The maser spots often occur in chains or filaments tracing arc-like structures [11, 14]. Although water masers can theoretically be pumped by radiation or collisions, it is generally thought that collisional pumping schemes are more prevalent under the conditions found in star forming regions [15, 16, 17]. The arc-like structures seen in VLBI maps of masers are therefore often interpreted as shock fronts where maser emission is excited by collisions [14, 16].

The proper motion and radial velocity of the maser spots also gives us a clue about their environment. The masers are often seen moving away from a central object at tens or sometimes even hundreds of kilometres per second. This outward movement can be in all directions, or constrained to two opposing directions. This motion could be explained by an outflow, driven by an accreting protostar at the centre [18, 19, 20].

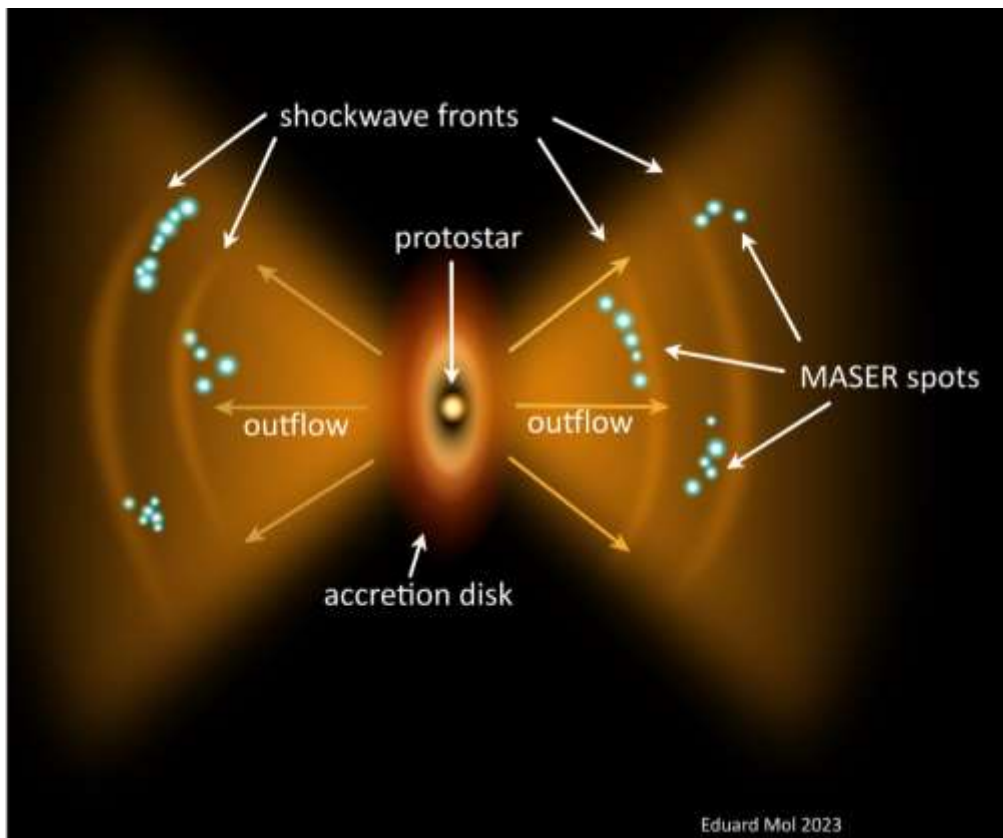

Figure 4: conceptual model of masers around a protostar.



### **Was the W51 flare triggered by an accretion burst?**

Massive protostars do not grow slowly and steadily. Rather, it seems that they accrete matter in rapid bursts. During such accretion bursts a large amount of heat is generated as material falls onto the protostar, causing a “heatwave” of IR radiation. This sudden burst of IR radiation can strongly increase radiative pumping in nearby maser clouds, causing the masers to flare. Shockwaves released during the accretion burst can similarly trigger flaring of certain maser types by increased collisional pumping. Recent monitoring programs by the Maser Monitoring Organization (M2O) have resulted in the discovery of flaring masers associated with accretion events [21, 22]. A previous water maser flare in W51 is even a candidate for one of those rare events [23].

However, there are a few problems when we try to explain the 2021 flare with an accretion burst. First of all, an increase in the infrared luminosity would be expected, followed by flaring of many different maser transitions [24]. During an earlier flare of the W51 water maser in 2016, many other maser types were observed including several rarely observed transitions of methanol and ammonia [23]. For the 2021 maser flare I could not find any report of increased activity of any maser type other than water masers (which of course does not mean it did not happen.) Another oddity is that the extreme flaring seems to be constrained to a single maser feature. This is quite different than most documented maser flares associated with accretion bursts: in these cases, many maser features over a broad range of velocities flared consecutively over several months, due to the IR radiation and shockwaves released during the accretion event passing through different maser spots in the region around the protostar [21, 22, 24].

### **Shock waves**

Water maser spots occurring in arcs are often interpreted as tracing shockwaves, pumping the masers by an increased collision rate. An intense shockwave passing through a particularly dense gas cloudlet could therefore plausibly generate a maser flare [11, 16]. However, such a shockwave is expected to pass through other clouds as well which could be moving at different velocities, causing consecutive flares of different features in the spectrum after the initial flare. Unless all the gas in the path of the supposed shockwave was moving at exactly the same line-of-sight velocity, this hypothesis does not explain the characteristics of the flare very well.

### **Geometric effects**

Maser flares could also simply reflect geometric effects like beaming, which have little to do with the physical properties of the protostar. For example, when two maser clouds overlap along the line of sight, the maser radiation of the background cloud can be amplified by the foreground cloud and thus a flare is observed [11, 13, 17, 25]. For this mechanism to occur the foreground maser needs to be unsaturated (which is often the case for water masers) and also move at the exact same radial velocity. The chances of such an alignment happening are therefore quite small and the resulting flares should be very rare. Furthermore, the flare would be confined to a single maser feature and a very narrow velocity range in the spectrum [11, 17]. Exceptional flares confined to a single maser feature, such as the 2021 flare of W51, could therefore be explained by a chance alignment of two or even several maser spots. The rapid variations observed during the flare may be the result of turbulence and inhomogeneity in the overlapping clouds. However, in the absence of VLBI maps and data from other maser transitions and IR flux, an accretion burst or shock-driven flare mechanism cannot be ruled out.

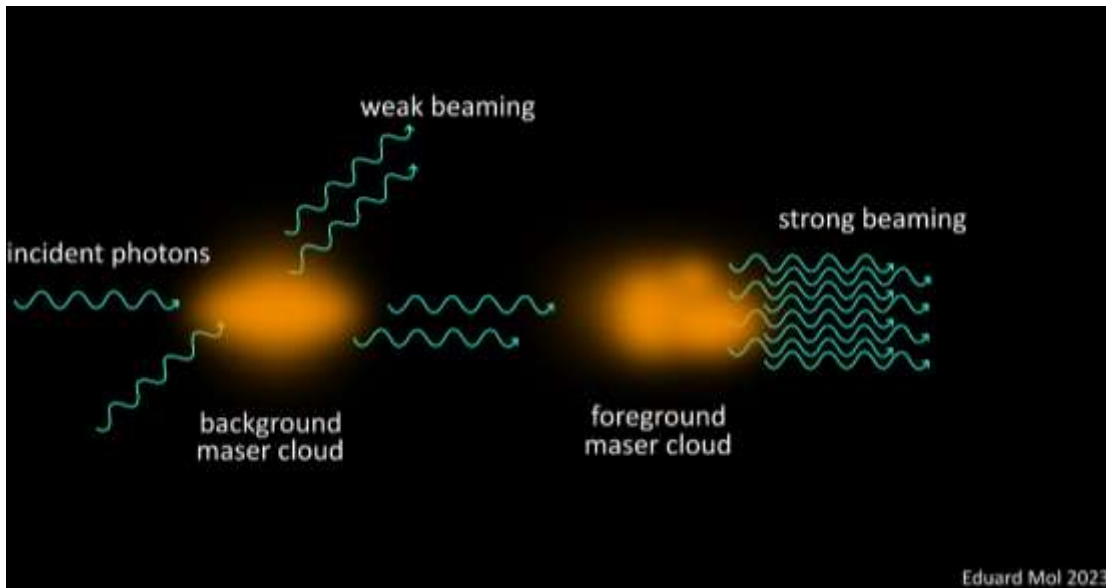

Figure 5: illustration of maser beaming due to maser clouds overlapping along the line of sight. Note that the foreground cloud can only amplify the radiation from the background cloud if both clouds are moving at the same velocity along the line of sight. If the foreground cloud is moving at a different velocity with respect to the background cloud, the radiation from the background cloud is slightly red- or blueshifted away from the water line frequency and thus cannot be amplified.

### Conclusion

Maser flaring events are not only of interest to professional astronomers but potentially also to amateurs. Flares can temporarily make sources that are otherwise difficult to detect much more accessible to small amateur instruments. Monitoring such flares with regular observations is also an exciting learning experience (after all, if your amateur telescope can only detect a handful of maser “stars”, then those stars better be very interesting and dynamic!). Comparison of the W51 data collected with a 1 metre dish with observations by a professional observatory showed that despite a lack of independent calibrations the general characteristics of the flare are still comparable. There could be an opportunity for amateurs to do regular monitoring of bright maser sources for flare events, analogous to what has already been done for pulsar glitches [26]. However, independent flux calibration remains a challenge, especially at those frequencies which are strongly affected by atmospheric conditions and/or RFI.

The mechanism behind the observed flare in W51 remains unclear, although the characteristics of the flare seem to favour a geometric explanation like the overlap of multiple maser clouds.

### References:

- 1) <https://astronomy.swin.edu.au/cosmos/m/Masers>
- 2) [https://en.wikipedia.org/wiki/Astrophysical\\_maser](https://en.wikipedia.org/wiki/Astrophysical_maser)
- 3) Sato, M., Reid, M. J., Brunthaler, A., & Menten, K. M. (2010). Trigonometric parallax of W51 main/south. *The Astrophysical Journal*, 720(2), 1055.
- 4) Minier, V., Conway, J. E., & Booth, R. S. (2001). VLBI observations of 6.7 and 12.2 GHz methanol masers toward high mass star-forming regions-II. Tracing massive protostars. *Astronomy & Astrophysics*, 369(1), 278-290.

- 5) ATel #15002: A flare of the H<sub>2</sub>O maser W51m  
<https://www.astronomerstelegam.org/?read=15002>
- 6) Volvach, A. E., Volvach, L. N. & Larionov, M. G. (2023). Unusually powerful flare phenomenon of the water maser in W51 and the possibility of detecting gravitational radiation from it. *The Astrophysical Journal*, 955(10).
- 7) Mol, E. (2023). Observations of the water maser sources W49 and W51. August 2023 SARA journal
- 8) Fedorov, D. (2023). Methanol maser 6.7 GHz in Cepheus A in August- September 2023. September- October 2023 SARA journal, p. 82-87
- 9) Herrmann, W. The 3-meter dish at the “Astropeiler Stockert” part 2: characterization and observations. [https://astropeiler.de/wp-content/uploads/2017/12/Part2\\_The\\_3-Meter\\_Dish\\_Astropeiler\\_Stockert\\_Characterisation\\_and\\_Observations.pdf](https://astropeiler.de/wp-content/uploads/2017/12/Part2_The_3-Meter_Dish_Astropeiler_Stockert_Characterisation_and_Observations.pdf)
- 10) “Radar astronomy”; Evans, T. V., & Hagfors, T., p. 95.
- 11) Burns, R. A., Orosz, G., Bayandina, O., Surcis, G., Olech, M., MacLeod, G., ... & Volvach, L. (2020). VLBI observations of the G25. 65+ 1.05 water maser superburst. *Monthly Notices of the Royal Astronomical Society*, 491(3), 4069-4075.
- 12) Gray, M. D., Etoke, S., Baggott, J., & Westlake, J. (2018, October). 3D Models of Maser Flares. In 14th European VLBI Network Symposium & Users Meeting (EVN 2018) (p. 73).
- 13) Deguchi, S., & Watson, W. D. (1989). Interacting masers and the extreme brightness of astrophysical water masers. *Astrophysical Journal, Part 2-Letters (ISSN 0004-637X)*, vol. 340, May 1, 1989, p. L17-L20., 340, L17-L20.
- 14) Torrelles, J. M., Patel, N. A., Gómez, J. F., Ho, P. T., Rodríguez, L. F., Anglada, G., ... & Cantó, J. (2001). Discovery of linear “building blocks” of water masers shaping linear/arcuate microstructures in Cepheus A. *The Astrophysical Journal*, 560(2), 853.
- 15) Kaufman, M. J., & Neufeld, D. A. (1996). Water maser emission from magnetohydrodynamic shock waves. *Astrophysical Journal* v. 456, p. 250, 456, 250.
- 16) Hollenbach, D., Elitzur, M., & McKee, C. F. (2013). Interstellar H<sub>2</sub>O masers from J shocks. *The Astrophysical Journal*, 773(1), 70.
- 17) Gray, M. D., Etoke, S., Richards, A. M. S., & Pimpanuwat, B. (2022). Collisional and radiative pumping in 22-GHz water masers. *Monthly Notices of the Royal Astronomical Society*, 513(1), 1354-1364.
- 18) Felli, M., Palagi, F., & Tofani, G. (1992). Molecular outflows and H<sub>2</sub>O masers-What type of connection?. *Astronomy and Astrophysics (ISSN 0004-6361)*, vol. 255, no. 1-2, p. 293-322., 255, 293-322.
- 19) Torrelles, J. M., Patel, N. A., Anglada, G., Gómez, J. F., Ho, P. T. P., Lara, L., ... & Rodríguez, L. F. (2003). Evidence for evolution of the outflow collimation in very young stellar objects. *The Astrophysical Journal*, 598(2), L115.
- 20) Claussen, Mark J., Kevin B. Marvel, Alwyn Wootten, and Bruce A. Wilking. "Distribution and motion of the water masers near IRAS 05413–0104." *The Astrophysical Journal* 507, no. 1 (1998): L79.

- 21) MacLeod, G. C., Smits, D. P., Goedhart, S., Hunter, T. R., Brogan, C. L., Chibueze, J. O., ... & Paulsen, J. D. (2018). A masing event in NGC 6334I: contemporaneous flaring of hydroxyl, methanol, and water masers. *Monthly Notices of the Royal Astronomical Society*, 478(1), 1077-1092.
- 22) Hirota, T., Cesaroni, R., Moscadelli, L., Sugiyama, K., Burns, R. A., Kim, J., ... & Yonekura, Y. (2020). Water maser variability in a high-mass YSO outburst--VERA and ALMA observations of S255 NIRS 3. arXiv preprint arXiv:2012.08052.
- 23) Zhang, Y. K., Chen, X., Sobolev, A. M., Shen, Z. Q., Li, B., & Zhao, Z. (2022). Three-month Monitoring of the Variability toward W51 IRS2 with Ammonia, Water, and Methanol Transitions. *The Astrophysical Journal Supplement Series*, 260(2), 34.
- 24) Bayandina, O. S., Brogan, C. L., Burns, R. A., Chen, X., Hunter, T. R., Kurtz, S. E., ... & Yonekura, Y. (2022). A Multitransition Methanol Maser Study of the Accretion Burst Source G358. 93-0.03-MM1. *The Astronomical Journal*, 163(2), 83.
- 25) Boboltz, D. A., Simonetti, J. H., Dennison, B., Diamond, P. J., & Uphoff, J. A. (1998). A water maser flare in W49N: amplification by a rotating foreground cloud. *The Astrophysical Journal*, 509(1), 256.
- 26) Vela pulsar observation project by Steve Olney: <https://sites.google.com/view/hawkrao/vela-pulsar-observations>

# Mapping the Milky Way by Cross Section Data/Graphs Interpretation

Felicia Lin

October 12th, 2023

## Abstract

About 73% of all visible mass in the universe is made of hydrogen. In other words, wherever there is visible mass significant enough to be recorded, it is almost guaranteed to contain an abundant amount of hydrogen. By simply collecting data on hydrogen in our galaxy, we can figure out the shape of our galaxy by some programming and math. The intensity of hydrogen emission tells us the amount of mass, and its velocity computed from the Doppler effect describes its relative distance from the center of the galaxy. To collect data, we maneuver the antenna across the sky to particular regions, and the data is put into a program called ezRA to produce interpretable graphs. To fully understand these graphs, in depth knowledge of how the antenna, program, and the math incorporated is very important. Background knowledge of Newtonian and electrical physics is necessary for comprehensive conclusions to be drawn on the data collected. At the end of collecting, refining, and interpreting data, we concluded that our findings are similar to what NASA had published of the spiral shape of our galaxy, with spiral arms generally matching up. What is more, we found the galaxy having a warped shape instead of being completely flat, as with many other studies done by other people.

## Proposal

How does our galaxy look in 3D space?

## Intro/background

To be able to discern the graphs formed from data collected from the sky, we have to first understand the different coordinate systems used to navigate our telescopes in the sky, and the ones used on the graphs displayed. Our Little Thompson Observatory-15ft radio telescope (LTO15) uses the elevation, azimuth coordinate system to navigate in the sky, where elevation is the angle above horizon and azimuth is the angle of cardinal directions with north being  $0.0^\circ/360^\circ$  and south being  $180^\circ$ . The coordinates for the data shown on the graphs we will study however, are generally in two kinds: galactic, and right ascension declination. Galactic coordinates use the sun as the origin and "longitudes" as the angle *on* the plane of the galaxy, with the galactic center as  $0.0^\circ$  and increasing to the left, and "latitudes" as the angle of *from* the galactic plane. We often can only see one or the other (longitude or latitude) at one time in 2D representation. Below is an example:



*This is a famous artistic interpretation of our galaxy by NASA in galactic longitude.*

[https://raw.githubusercontent.com/varenius/salsa/main/Lab\\_instructions/Hi/English/SALSA-HI\\_English.pdf](https://raw.githubusercontent.com/varenius/salsa/main/Lab_instructions/Hi/English/SALSA-HI_English.pdf)

Of course, we can't see our own galaxy with a top view, so this is an artistic interpretation of what our galaxy may look like backed with mathematical calculations and a plethora of data. The last coordinate system is the right ascension declination, which maps the sky using the center of the earth as the origin. In other words, the horizontal axis and vertical axis are the longitude and latitude respectively and the map displays what is seen directed above the sky at those coordinates on earth. Example of our galaxy graphed with this coordinate system could be seen below:

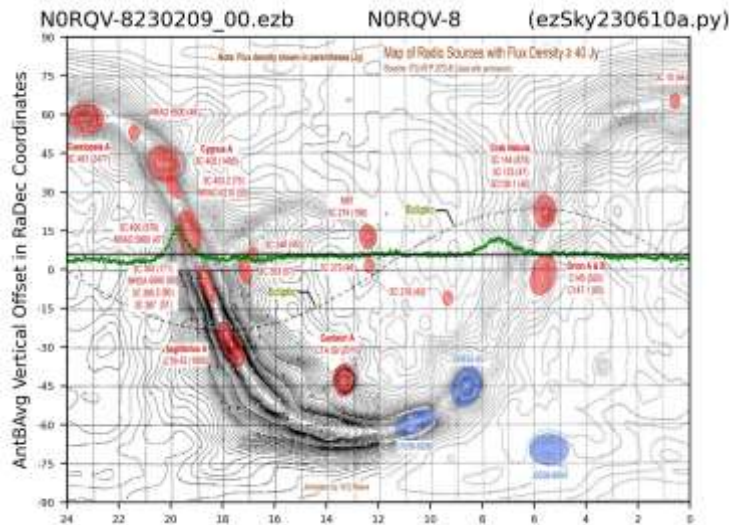

*The green line represents detected hydrogen of a drift scan across the sky at a certain elevation in RaDec.*

The general U shaped line is the detected galaxy and the dotted line represents the sun's apparent path during one full year. They form sinusoidal lines due to the difference of the axis that the earth rotates on and the plane that the earth orbits the sun. The earth's equator is tilted around 23 degrees from the plane of the solar system, and the plane of the solar system is at about a 60 degrees angle from the plane of the galaxy. We are  $\frac{2}{3}$  of the way from the center of the milky way, and the center could be seen at the emphasized region, at the bottom left of the U shape. Understanding these graphs comes in handy when interpreting and analyzing more complex or detailed graphs later on.

But what is it that we are detecting in the sky? Hydrogen emits an electromagnetic wavelength of 21cm ( $\approx 1420$  MHz) spontaneously from the change of the spin of its electron. When the electron changes its spin from the same direction with the proton to opposite from it, it releases energy. This rarely happens, but since there are so many hydrogen atoms it adds up to a detectable amount. The reason to use this particular energy emitted from hydrogen other than its abundance is because it is a radio wave, which is able to pass through dust in space *and* our atmosphere. That means we can collect data right on the ground level of earth.

### Procedure/Methods

#### Materials

We used the LTO (Little Thompson Observatory) 15 ft antenna for most of our project, which has motors that can track one particular point in the sky, making it more efficient than the LTO 16 we used at first that can only collect data at one elevation of the sky at a time. The calibration of our motors is from Massachusetts Institute of Technology Haystack (MIT's program that offers research opportunities for undergraduates in science, engineering and computer science. It also provides a free online database for information on ways to collect data from the sky, including procedure and calibrations, etc.).



*An image of the LTO (taken by Ted Cline) and the antennas we used.*

In order to retain any data collected to the maximal amount, we connected the Nooelec SAWbird+ H1 Barebones Low Noise Amplifier (centered at 1420 MHz) to the antenna almost immediately after the data was received. Putting the amplifier in the same environment also serves as a better reference to actual data.

Lastly, we used the ezRA program (written by my mentor, Ted Cline) to transform raw data into many different types of graphs that allow analysis.

### Method (understanding how the data collected was processed)

For the main project, we chose a certain galactic longitude that we want to study on, and operate the LTO 15 to collect data at the certain longitude with plus or minus 9 degrees latitude.

To refine our data, we compared collected data to data from the antenna itself as a reference to minimize environmental/antenna factors. For instance, the antenna would be directed at the sky, collect a data point, then it would be instructed through an electrical signal from the program to collect data from the Low Noise Amplifier's resistor. By toggling the signals back and forth, approximately every data sample would have an immediate reference sample that by comparing, we would be able to factor out many other environmental variables. This method is more effective than using another frequency - for example 1423 MHz - as reference due to possible noise from other frequencies.

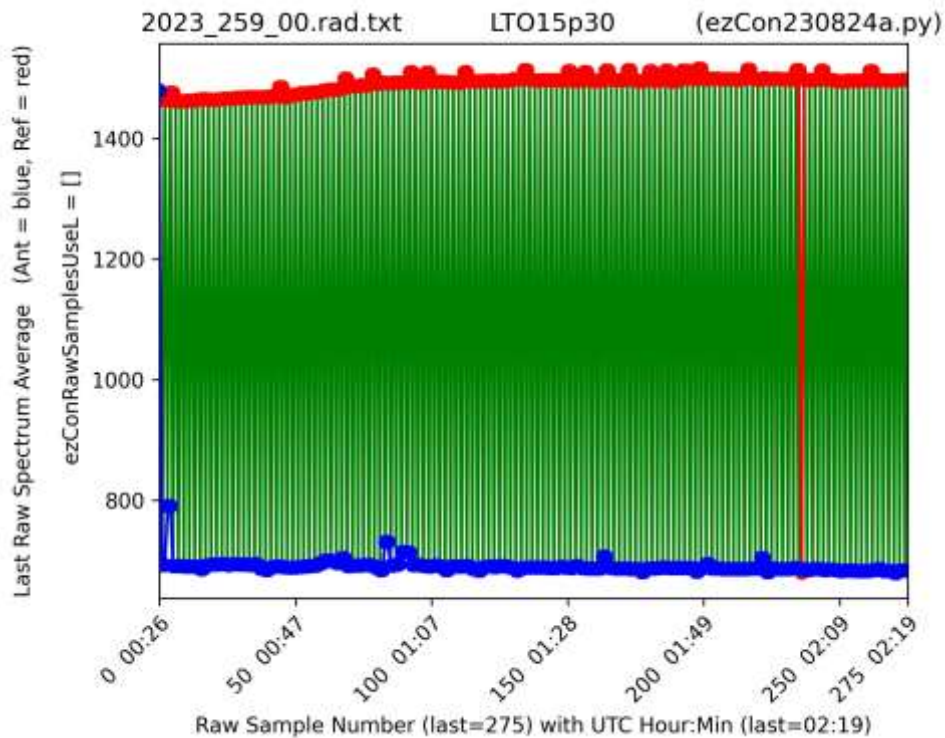

*This is an image showing how the antenna switches back and forth from looking at the sky(red) to looking at itself(blue). The red line indicates a machine error that will need to be cleaned later in the data refinement process.*

To further clean the graphs, ezRA would crop the “edges” of the graph that have too much noise collected from higher or lower frequencies that is obviously unrelated to hydrogen. Sometimes manual replacement of outliers with neighbor data is required. An example shown below:



```

Activities | Text Editor | Sep 29 11:32
ezConStudy2023_272_00.rad.txt
- /ezRBlaw/term1581230625/term1182

zzz_stem15230929a.sh | ezConStudy2023_272_00.rad.txt | 2023_271_23.rad | 2023_272_00.rad

755 Maybe try arguments like -ezConAntSampleSnip 177
756
757 Sample numbers of 20 lowest-values of AntRBTVAvg:
758 t = 0 sample 128 AntRBTVAvg = 0.9198347070482493 0.0 %
759 t = 1 sample 129 AntRBTVAvg = 0.9369353457931107 16.68167552398334 % <===== > 5%
760 t = 2 sample 1 AntRBTVAvg = 1.0020259103610931 80.17753058361236 % <===== > 5%
761 t = 3 sample 80 AntRBTVAvg = 1.0024713019704355 80.61201008879502 % <===== > 5%
762 t = 4 sample 117 AntRBTVAvg = 1.002592940766574 80.73066874389677 % <===== > 5%
763
764 t = 5 sample 20 AntRBTVAvg = 1.0058319302606602 83.89030346116935 % <===== > 5%
765 t = 6 sample 4 AntRBTVAvg = 1.0060824721330441 84.134707887402 % <===== > 5%
766 t = 7 sample 3 AntRBTVAvg = 1.0062441718586295 84.29244519267186 % <===== > 5%
767 t = 8 sample 8 AntRBTVAvg = 1.006247424594422 84.29561823689933 % <===== > 5%
768 t = 9 sample 22 AntRBTVAvg = 1.006276548565685 84.32402807500208 % <===== > 5%
769
770 t = 10 sample 7 AntRBTVAvg = 1.0064403978687968 84.48366368565815 % <===== > 5%
771 t = 11 sample 6 AntRBTVAvg = 1.0064497254637443 84.49296276365804 % <===== > 5%
772 t = 12 sample 200 AntRBTVAvg = 1.0064741851211985 84.5167451229585 % <===== > 5%
773 t = 13 sample 2 AntRBTVAvg = 1.0064780542474518 84.5205974961794 % <===== > 5%
774 t = 14 sample 23 AntRBTVAvg = 1.0064928184418022 84.5349921659221 % <===== > 5%
775
776 t = 15 sample 275 AntRBTVAvg = 1.0065062294677294 84.54888242756103 % <===== > 5%
777 t = 16 sample 21 AntRBTVAvg = 1.0065103040903902 84.55205722254526 % <===== > 5%
778 t = 17 sample 201 AntRBTVAvg = 1.0065294704330627 84.57075399254393 % <===== > 5%
779 t = 18 sample 9 AntRBTVAvg = 1.0066552085235618 84.6934115176886 % <===== > 5%
780 t = 19 sample 15 AntRBTVAvg = 1.0067108925137793 84.75358425889685 % <===== > 5%
781 Maybe try arguments like -ezConAntSampleSnip 128
782
783 Sample numbers of 20 largest change values of AntRBTVAvg:
784 t = 0 sample 128 AntRBTVAvgDelta = -0.09769874187483318 -95.30513657212342 %
785 t = 1 sample 130 AntRBTVAvgDelta = 0.08074162464498724 78.76348630649765 %
786 t = 2 sample 129 AntRBTVAvgDelta = 0.01710063874486134 16.68167552398334 %
787 t = 3 sample 118 AntRBTVAvgDelta = 0.013218183861817945 12.894340234185824 %
788 t = 4 sample 80 AntRBTVAvgDelta = -0.012789682728945895 -12.476337318221189 %
789
Plain Text | Tab Width: 8

```

From the data points it could be seen that sample number 128 was eminently much lower than the rest of the data. The 0% indicates that if we reference sample 128 as the baseline energy level, most of the rest of the data sets would lie at 80%, which is a tremendous jump. This could be confirmed again in the data set under which indicates that the change from 128 to its surrounding data sample was -95%! We could infer the 78% jump of sample 130 was also caused by sample 129, but there is no explanation for the jump of sample 129 itself, therefore we know for sure that the results of sample 129 was caused by some error or noise, and deleting it would be a safe and wise choice.

After refining the data from the resistor, it still needs to be adjusted from the Doppler effect due to the velocity of the earth's rotation, orbit, and the velocity of our solar system itself (with respect to neighboring stars). Where the faster objects are receding, the lower their detected frequency (Hz) are compared to their true Hz. Vice versa with objects approaching. The general procedure boils down to comparing Antenna data (Ant) with the Reference data (Ref), then trimming the result (AntRB into AntRBT), then adjusting the velocities to the correct frequencies (AntRBTV). Finally, after the adjustment, the program often trims the data again, so the data we analyze is usually the AntRBTVT version.

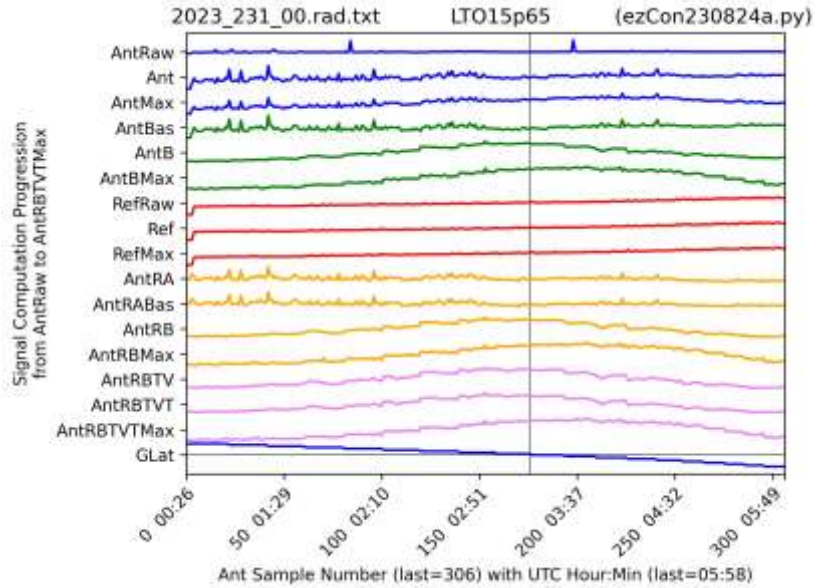

A condensed graph of different kinds of processing. The black vertical line in the middle indicates where the antenna crosses the galaxy, in which from the more filtered versions (pink) it could be seen that intensity detected is higher near the galaxy.

However, in addition to the Doppler effect from our own velocity, the velocity (speed and direction) of hydrogen(H) in orbit around the center of the galaxy also creates different Doppler effects depending on our line of sight. The H-clouds traveling right along our line of sight (longitude degree) would appear the fastest moving away, and we could find them with the lowest Hz detected. Using this highest-reference-velocity and some trigonometry, we can figure out an equation for the actual velocities of the H-clouds, then use that information to trig out their radius from the center of the galaxy.

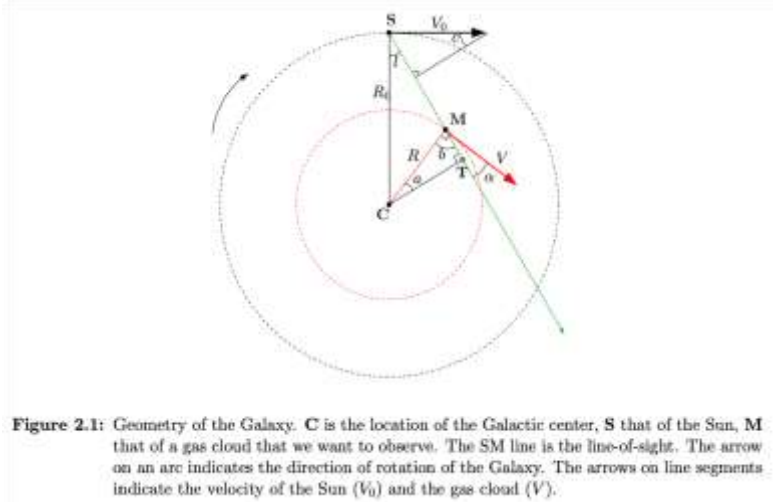

- $V_0$  Sun's velocity around the Galactic center, i.e. 220 km/s
- $R_0$  Distance of the Sun to the Galactic center, i.e. 8.5 kpc)
- $l$  Galactic longitude of observation
- $V$  Velocity of a cloud of gas
- $R$  Cloud's distance to the Galactic center

From the graph we could see with geometry that  $l=c$  and  $\alpha=a$ . Using trig and similar triangles, we get:  $CT = R(0) \sin(l) = R \cos(a)$ , and by rearranging the equation,  $\cos(a) = R(0) \sin(l)/R$ . We can also figure out the relative velocity between us and the hydrogen clouds  $V(R) = V \cos(\alpha) - V(0) \sin(c)$ . We can substitute the  $\cos(\alpha)$  to get:

$$V_r = V \frac{R_0}{R} \sin l - V_0 \sin l.$$

[https://raw.githubusercontent.com/varenius/salsa/main/Lab\\_instructions/HI/English/SALSA-HI\\_English.pdf](https://raw.githubusercontent.com/varenius/salsa/main/Lab_instructions/HI/English/SALSA-HI_English.pdf)

But since  $R(0) \sin(l) = R$  when we measure the max of  $V(R)$ , we can simplify and rewrite the equation:

$$V = V_{r,max} + V_0 \sin l.$$

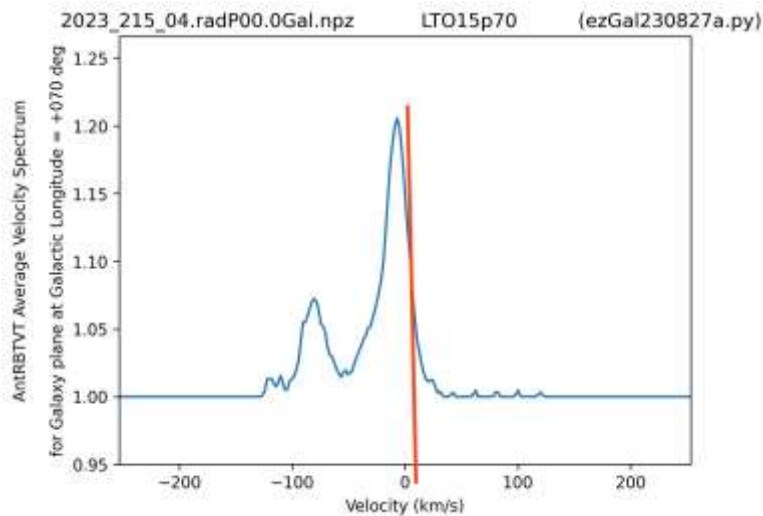

*An example from galactic longitude 70° where we want to measure the highest-statistically significant velocity. If this was a graph of frequencies instead of velocities, then we would want to find the lowest Hz, because according to the Doppler effect, the faster objects are moving away, the lower the Hz of the energies they emit will appear.*

At this point, we have found a way to figure out the velocity of the hydrogen at a given longitude( $l$ ) by measuring the max velocity. Strangely, from our calculations, we observe an absurd phenomenon in our galaxy. Although Kepler's laws state that "a planet covers the same area of space in the same amount of time no matter where it is in its orbit," meaning objects orbiting in space further from the center should have lower velocity, and vice versa. (Orbits and Kepler's laws - Nasa Science) However, from our own measurement and as well as previous work done by both amateurs and professionals, data results show that objects orbiting in our galaxy, regardless of distance to the center, all have approximately the same velocity. Scientists explain this phenomenon with the existence of dark matter - basically meaning extra matter that we can't/didn't directly detect - since this phenomenon of equal velocity would make sense if the galaxy was more dense than we had imagined.

With this assumption though, we can set  $V(0)=V$ , and the boxed equation would become:

$$V_r = V_0 \sin l \left( \frac{R_0}{R} - 1 \right).$$

[https://raw.githubusercontent.com/varenius/salsa/main/Lab\\_instructions/HI/English/SALSA-HI\\_English.pdf](https://raw.githubusercontent.com/varenius/salsa/main/Lab_instructions/HI/English/SALSA-HI_English.pdf)

And by rearranging we get R(the distance we want to know) as a function of known variables:

$$R = \frac{R_0 V_0 \sin l}{V_0 \sin l + V_r}.$$

The ezRA program uses this equation to calculate R of the hydrogen cloud from the center of galaxy and from that their distance from our sun in the cross sectional graphs of the galaxy. The program interpolates between the data we collected, but it is important to note that the interpolation may not always be reliable due to inevitable holes in data collection from limited time.

# Results

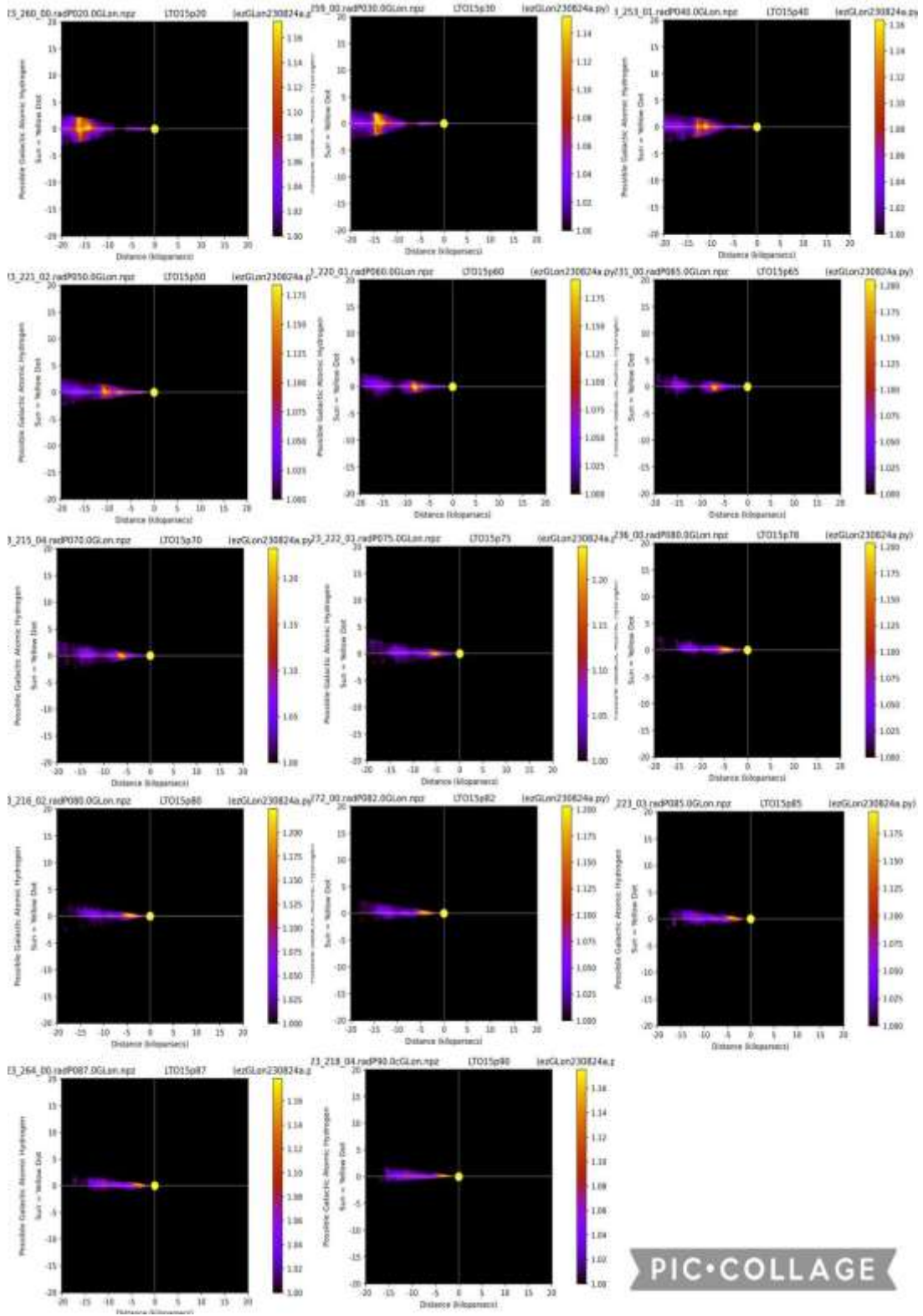

Collage of cross section data (with distance in kiloparsecs, latitude angle in degrees, and relative intensity) of different longitudes of our galaxy.

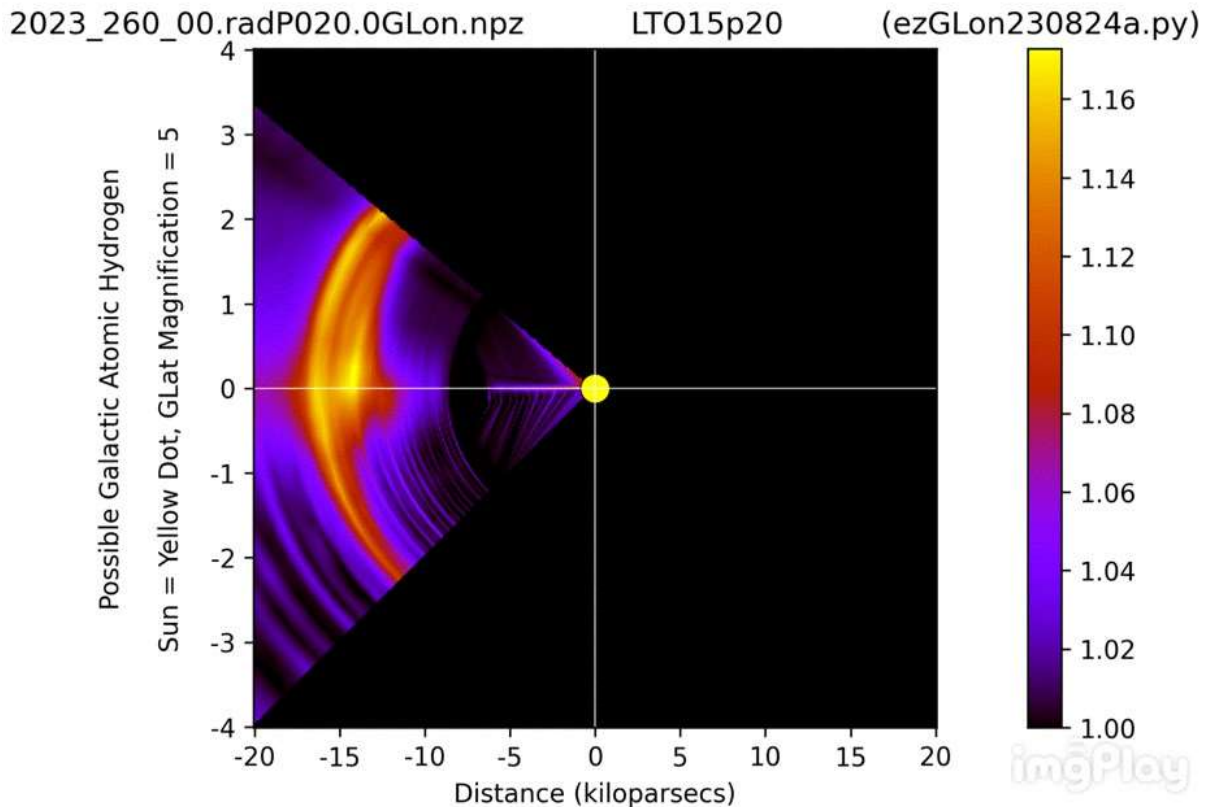

*Here is a GIF of the cross sections but dilated and interpolated, in which it seems skewed.*

We see many brighter spots of relative energy appearing above and below the  $0^\circ$  latitude line. This variation from the  $0^\circ$  could be seen especially from longitude  $65^\circ$  through  $90^\circ$  where the brightest spot gradually went from just below the  $0^\circ$  to above. Less prominent trends of the same could be seen from the dimmer spots. In this case the spots would represent the intensity and size of the Milky Way's galactic arms.

A trend of higher luminosity and larger spots to lower luminosity to smaller spots could also be observed from smaller longitude degrees to larger ones. It is also important to note that the bright spots seem to come closer and closer to us as the longitude degrees increase, and there are also spots that disappear as they slowly fade and maybe reappear elsewhere.

Similar patterns could be seen in NASA's representation of the galaxy (first figure) where the arms of our galaxy were not always continuous. The brightest spots seem to be the energy captured from the Perseus arm represented from NASA's graph, judging from the distances in light years on NASA's graph matching up with the distance in our graphs in kiloparsecs.

### **Conclusion:**

Our data collection on the shape of our galaxy of the first quadrant in galactic coordinates suggests our galaxy is warped, with spiral arms of different intensity. The intensity increases as it approaches  $0^\circ$  galactic longitude indicating a higher mass density near the center. We found nothing at the place where the center of the galaxy should be, so we hypothesize that the surrounding mass is at such high energy levels the hydrogen is ionized and does not emit 1420 MHz.

Data of longitude  $82^\circ$  had a slit missing in one of its angles, due to missing data. Weather conditions and faults from the antenna could cause error or inaccuracy from the antenna, but were mostly filtered out by the program or manually after the results were analyzed. The final results were generally expected, although some data may be skewed, the shape of the galactic arms typically fit the results from NASA. This provides additional evidence on the shape of our galaxy and our position in it.

As science and exploration of space advances, data about the galaxy yielded from many individual observations are critical for any further hypothesis to build upon these foundations. Although our observations were not the first, it strengthens the results attained by others, hence making the current leading hypothesis of the shape of our milky way more credible. For example, other than just data on our galaxy, we provided more evidence on the subject of dark matter from the data we obtained on calculating the velocity of H-clouds with different radius from the center.

Further investigation could be done to determine the shape of the other half of our galaxy, but different procedures for the mathematics would be necessary. More data collected on the same portion of the galaxy could be put into the ezRA program to produce an even more complete data set.

### **Bibliography**

Cline TC (2023). ezRA - Easy Radio Astronomy. GitHub. <https://github.com/tedcline/ezRA>

F1EHN, J.-J. M. (2020). RADIOASTRONOMIE Observation de notre galaxie à 21 cm. France; CC BY-SA.  
[https://f1ehn.pagesperso-orange.fr/pages\\_radioastro/Images\\_Docs/Radioastro\\_21cm\\_20`12b.pdf](https://f1ehn.pagesperso-orange.fr/pages_radioastro/Images_Docs/Radioastro_21cm_20`12b.pdf)

Campbell, B. (2021). Pointing & Single-Dish Amplitude Calibration. Boston; MIT Haystack.  
[https://www.haystack.mit.edu/wp-content/uploads/2021/05/TOW2021\\_Campbell.pdf](https://www.haystack.mit.edu/wp-content/uploads/2021/05/TOW2021_Campbell.pdf)

Horellou, C., Johansson, D., & Varenus, E. (2015, December 9). SALSA project documentation: Mapping the Milky Way. Onsala; Chalmers University of Technology.  
[https://raw.githubusercontent.com/varenus/salsa/main/Lab\\_instructions/HI/English/SALSA-HI\\_English.pdf](https://raw.githubusercontent.com/varenus/salsa/main/Lab_instructions/HI/English/SALSA-HI_English.pdf)

Production of Educational Videos(ES.333 MIT). (2015). Mapping the Galaxy with Radio Astronomy. Retrieved September 22, 2023, from <https://www.youtube.com/watch?v=-UrzmAa62ho>.

Zell, H. (2015, March 2). Milky way and our location. NASA.  
[https://www.nasa.gov/mission\\_pages/sunearth/news/gallery/galaxy-location.html](https://www.nasa.gov/mission_pages/sunearth/news/gallery/galaxy-location.html)

Morgan, W. W. (1958). REPORTS ON THE PROGRESS OF ASTRONOMY THE GALACTIC SYSTEM AS A SPIRAL NEBULA. Boston; Royal Astronomical Society/NASA Astrophysics Data System.

SMD Content Editors, N. (n.d.). Orbits and Kepler's laws - Nasa Science.  
<https://science.nasa.gov/resource/orbits-and-keplers-laws/>

**Fast Radio Bursts (FRBs)**  
**Dave Hinzel**  
**Argent Astro Research Institute (AARI)**

**Abstract**

In radio astronomy, a Fast Radio Burst (FRB) is a transient radio pulse with a period between a fraction of a millisecond to approximately three seconds. The first FRB was detected in 2007 as a result of research into archival pulsar survey data recorded by Parkes Observatory. FRBs are caused by high-energy astrophysical processes that are not yet understood, although there are several proposed mechanisms. Most FRBs appear to be extragalactic. FRBs are characterized by short duration, broadband pulses which exhibit frequency dependent arrival time delay due to dispersion similar to radio pulsars, but typically have much larger dispersive delays indicating possible extragalactic origin. This article presents recent literature on FRBs, including the phenomenology and underlying physics, observational data, possible FRB models gleaned from the data, propagation effects, and other information from current FRB research.

**Introduction and Background**

Fast Radio Bursts are bright unresolved point sources with broadband frequency ranges and signal strengths strong enough to stand out above the ambient noise floor. The burst usually appears as a single spike of energy without any variation over the signal interval. Only a few sources are known to repeat. FRBs are now established as an extragalactic phenomenon. Observational data is trying to establish the physical origin of FRBs. They predominantly originate from cosmological distances so that their sources produce the most extreme coherent radio emission in the universe. Many models exist, ranging from alien spacecraft to cosmic strings, but those concerning compact objects and supermassive black holes have gained the most attention. At least some FRBs are produced by magnetars, neutron stars with the strongest magnetic fields in the universe.

The definition of an FRB is a radio burst satisfying three requirements. First, the burst should be really “fast”, with a duration of milliseconds. Second, the brightness temperature of this burst should be significantly higher than that of pulsar radio emission. Third, the total dispersion measure (DM) of this burst is expected to exceed the value that galactic electrons can contribute in order to distinguish it from a rotation radio transient. However, the relative contributions of host galaxies and the intergalactic medium to propagation effects have yet to be disentangled, so dispersion measure distances have large uncertainties. Before reaching the Earth, an FRB signal has experienced multiple propagation effects caused by the plasma on its path, including dispersion, scattering, scintillation, absorption, Faraday rotation, and plasma lensing.

FRBs are found using data that are essentially the same as those used in pulsar surveys, namely high time resolution spectra (approximately 100  $\mu$ s) with approximately 1,000 frequency channels across a total bandwidth of hundreds of megahertz. The key difference is that pulsar surveys seek periodic signals using Fourier methods, which become insensitive to periods that are not small compared to data spans and, of course, are completely insensitive to single pulses. Figure 1 shows the distribution of FRBs detected by several ground based systems including Parkes, Green Bank Telescope (GBT), the Very Large Array (VLA) and the Canadian Hydrogen Intensity Mapping Experiment Fast Radio Burst project (CHIME/FRB). The CHIME/FRB system's currently published sample now exceeds 600 unique sources.



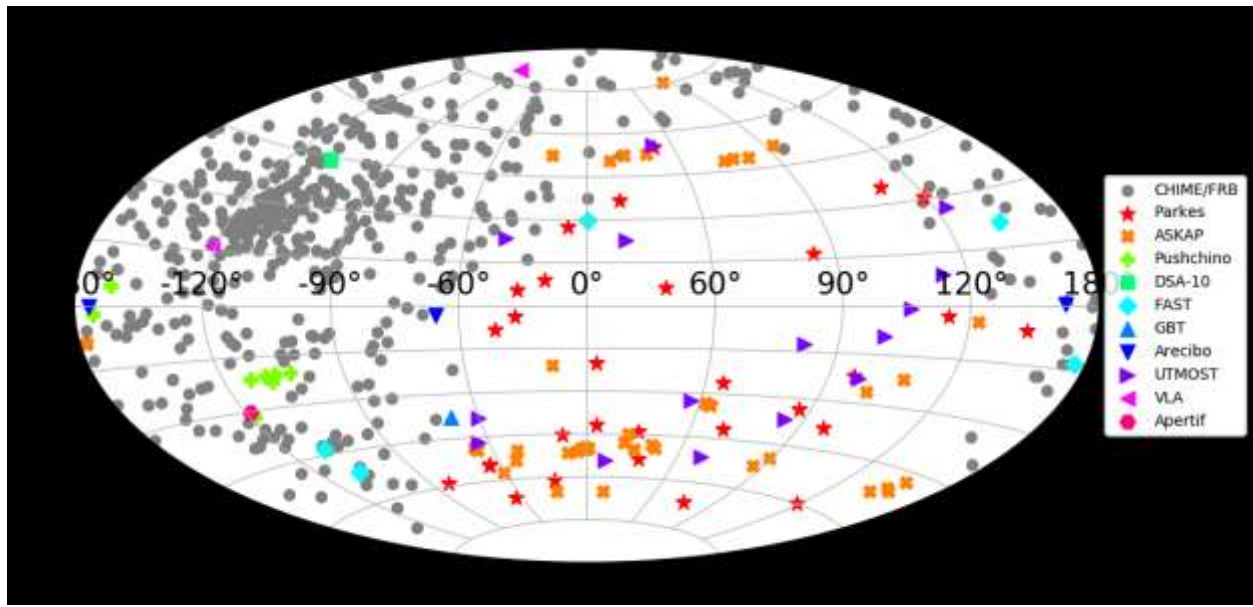

**Figure 1: Currently known sample of FRBs in galactic coordinates**  
 (E. Petroff, et.al, arXiv:2107.10113v2 [astro-ph.HE] 19 Jan 2022)

### FRB Physics

As previously mentioned, many FRB models exist. Those models concerning compact objects, supermassive black holes, and magnetars are discussed in the links below.

#### Fast Radio Bursts-Wikipedia

In radio astronomy, a fast radio burst (FRB) is a transient radio pulse of length ranging from a fraction of a millisecond, for an ultra-fast radio burst, to 3 seconds, caused by some high-energy astrophysical process not yet understood. Astronomers estimate the average FRB releases as much energy in a millisecond as the Sun puts out in three days. While extremely energetic at their source, the strength of the signal reaching Earth has been described as 1,000 times less than from a mobile phone on the moon.

#### Fast Radio Bursts (Di Xiao, et.al, arXiv:2203.14198v1 [astro-ph.HE] 27 Mar 2022)

Abstract: The era of fast radio bursts (FRBs) was open in 2007, when a very bright radio pulse of unknown origin was discovered occasionally in the archival data of Parkes Telescope. Over the past fifteen years, this mysterious phenomenon has caught substantial attention among the scientific community and become one of the hottest topics in high-energy astrophysics. The total number of events has increased dramatically to a few hundred recently, benefiting from new dedicated surveys and improved observational techniques. Our understanding of these bursts has been undergoing a revolutionary growth with observational breakthroughs announced consistently. In this chapter, we will give a comprehensive introduction of FRBs, including the latest progress. Starting from the basics, we will go through population study, inherent physical mechanism, and all the way to the application in cosmology. Plenty of open questions exist right now and there is more surprise to come in this active young field.

#### Fast radio bursts at the dawn of the 2020s (E. Petroff, et.al, arXiv:2107.10113v2 [astro-ph.HE] 19 Jan 2022)

Abstract: Since the discovery of the first fast radio burst (FRB) in 2007, and their confirmation as an abundant extragalactic population in 2013, the study of these sources has expanded at an incredible rate. In our 2019 review on the subject we presented a growing, but still mysterious, population of FRBs -- 60 unique sources, 2 repeating FRBs, and only 1 identified host galaxy. However, in only a few short years new observations and

discoveries have given us a wealth of information about these sources. The total FRB population now stands at over 600 published sources, 24 repeaters, and 19 host galaxies. Higher time resolution data, sustained monitoring, and precision localizations have given us insight into repeaters, host galaxies, burst morphology, source activity, progenitor models, and the use of FRBs as cosmological probes. The recent detection of a bright FRB-like burst from the Galactic magnetar SGR~1935+2154 provides an important link between FRBs and magnetars. There also continue to be surprising discoveries, like periodic modulation of activity from repeaters and the localization of one FRB source to a relatively nearby globular cluster associated with the M81 galaxy. In this review, we summarize the exciting observational results from the past few years. We also highlight their impact on our understanding of the FRB population and proposed progenitor models. We build on the introduction to FRBs in our earlier review, update our readers on recent results, and discuss interesting avenues for exploration as the field enters a new regime where hundreds to thousands of new FRBs will be discovered and reported each year.

### **Magnetar-Wikipedia**

Abstract: A magnetar is a type of [neutron star](#) with an extremely powerful magnetic field ( $\sim 10^9$  to  $10^{11}$  T,  $\sim 10^{13}$  to  $10^{15}$  G). The magnetic-field decay powers the emission of high-energy [electromagnetic radiation](#), particularly [X-rays](#) and [gamma rays](#). The existence of magnetars was proposed in 1992 by [Robert Duncan](#) and [Christopher Thompson](#). Their proposal sought to explain the properties of transient sources of gamma rays, now known as [soft gamma repeaters](#) (SGRs). Over the following decade, the magnetar hypothesis became widely accepted, and was extended to explain [anomalous X-ray pulsars](#) (AXPs). As of July 2021, 24 confirmed magnetars were known. It has been suggested that magnetars are the source of [fast radio bursts](#) (FRB), in particular as a result of findings in 2020 by scientists using the [Australian Square Kilometre Array Pathfinder](#) (ASKAP) radio telescope.

### **Fast Radio Bursts: An Extragalactic Enigma** (J.M. Cordes, et.al, arXiv:1906.05878v2 [astro-ph.HE] 22 Aug 2019)

Abstract: We summarize our understanding of millisecond radio bursts from an extragalactic population of sources. FRBs occur at an extraordinary rate, thousands per day over the entire sky with radiation energy densities at the source about ten billion times larger than those from Galactic pulsars. We survey FRB phenomenology, source models and host galaxies, coherent radiation models, and the role of plasma propagation effects in burst detection. The FRB field is guaranteed to be exciting: new telescopes will expand the sample from the current approximately 80 unique burst sources (and a few secure localizations and redshifts) to thousands, with burst localizations that enable host-galaxy redshifts emerging directly from interferometric surveys.

\* FRBs are now established as an extragalactic phenomenon.

\* Only a few sources are known to repeat. Despite the failure to redetect other FRBs, they are not inconsistent with all being repeaters.

\* FRB sources may be new, exotic kinds of objects or known types in extreme circumstances. Many inventive models exist, ranging from alien spacecraft to cosmic strings but those concerning compact objects and supermassive black holes have gained the most attention. A rapidly rotating magnetar is a promising explanation for FRB 121102 along with the persistent source associated with it, but alternative source models are not ruled out for it or other FRBs.

\* FRBs are powerful tracers of circumsource environments, 'missing baryons' in the IGM, and dark matter.

\* The relative contributions of host galaxies and the IGM to propagation effects have yet to be disentangled, so dispersion measure distances have large uncertainties.

### **The Physics of Fast Radio Bursts** (B. Zhang, arXiv:2212.03972v1 [astro-ph.HE] 7 Dec 2022)

Abstract: Fast radio bursts (FRBs), millisecond-duration bursts prevailing in the radio sky, are the latest big puzzle in the universe and have been a subject of intense observational and theoretical investigations in recent years. The rapid accumulation of the observational data has painted the following sketch about the physical origin of FRBs: They predominantly originate from cosmological distances so that their sources produce the most

extreme coherent radio emission in the universe; at least some, probably most, FRBs are repeating sources that do not invoke cataclysmic events; and at least some FRBs are produced by magnetars, neutron stars with the strongest magnetic fields in the universe. Many open questions regarding the physical origin(s) and mechanism(s) of FRBs remain. This article reviews the phenomenology and possible underlying physics of FRBs. Topics include: a summary of the observational data, basic plasma physics, general constraints on FRB models from the data, radiation mechanisms, source and environment models, propagation effects, as well as FRBs as cosmological probes. Current pressing problems and future prospects are also discussed. Additional information regarding the physics of FRBs can be found at [The Physical Mechanisms of Fast Radio Bursts](#) (B. Zhang, arXiv:2011.03500v1 [astro-ph.HE] 6 Nov 2020).

**[The McGill Magnetar Catalog](#)** (S. Olausen and V. Kaspi, arXiv:1309.4167v3 [astro-ph.HE] 27 Mar 2014)

Abstract: We present a catalog of the 26 currently known magnetars and magnetar candidates. We tabulate astrometric and timing data for all catalog sources, as well as their observed radiative properties, particularly the spectral parameters of the quiescent X-ray emission. We show histograms of the spatial and timing properties of the magnetars, comparing them with the known pulsar population, and we investigate and plot possible correlations between their timing, X-ray, and multiwavelength properties. We find the scale height of magnetars to be in the range 20-31 pc, assuming they are exponentially distributed. This range is smaller than that measured for OB stars, providing evidence that magnetars are born from the most massive O stars. From the same fits, we find that the Sun lies  $\sim 13$ -22 pc above the Galactic plane, consistent with previous measurements. We confirm previously identified correlations between quiescent X-ray luminosity  $L_X$  and magnetic field  $B$ , as well as X-ray spectral power-law index  $\Gamma$  and  $B$ , and show evidence for an excluded region in a plot of  $L_X$  vs.  $\Gamma$ . We also present an updated  $kT$  versus characteristic age plot, showing magnetars and high- $B$  radio pulsars are hotter than lower- $B$  neutron stars of similar age. Finally, we observe a striking difference between magnetars detected in the the hard X-ray and radio bands; there is a clear correlation between the hard and soft X-ray flux, whereas the radio-detected magnetars all have low soft X-ray flux suggesting, if anything, that the two bands are anti-correlated. An online version of the catalog is located at [McGill Online Magnetar Catalog](#).

**[FRBCAT: The Fast Radio Burst Catalogue](#)** (E. Petroff, et. al, arXiv:1601.03547v1 [astro-ph.HE] 14 Jan 2016)

Abstract: Here we present a catalogue of known Fast Radio Burst (FRB) sources in the form of an online catalogue, FRBCAT. The catalogue includes information about the instrumentation used for the observations for each detected burst, the measured quantities from each observation, and model-dependent quantities derived from observed quantities. To aid in consistent comparisons of burst properties such as width and signal-to-noise ratios we have reprocessed all the bursts for which we have access to the raw data, with software which we make available. The originally derived properties are also listed for comparison. The catalogue is hosted online as a MySQL database which can also be downloaded in tabular or plain text format for off-line use. This database will be maintained for use by the community for studies of the FRB population as it grows.

**[The First CHIME/FRB Fast Radio Burst Catalog](#)** (The CHIME/FRB Collaboration, arXiv:2106.04352v3 [astro-ph.HE] 31 Jan 2023)

Abstract: We present a catalog of 536 fast radio bursts (FRBs) detected by the [Canadian Hydrogen Intensity Mapping Experiment](#) Fast Radio Burst (CHIME/FRB) Project between 400 and 800 MHz from 2018 July 25 to 2019 July 1, including 62 bursts from 18 previously reported repeating sources. The catalog represents the first large sample, including bursts from repeaters and non-repeaters, observed in a single survey with uniform selection effects. This facilitates comparative and absolute studies of the FRB population. We show that repeaters and apparent non-repeaters have sky locations and dispersion measures (DMs) that are consistent with being drawn from the same distribution. However, bursts from repeating sources differ from apparent non-repeaters in intrinsic temporal width and spectral bandwidth. Through injection of simulated events into our detection pipeline, we perform an absolute calibration of selection effects to account for systematic biases. We find

evidence for a population of FRBs - comprising a large fraction of the overall population - with a scattering time at 600 MHz in excess of 10 ms, of which only a small fraction are observed by CHIME/FRB. We infer a power-law index for the cumulative fluence distribution of  $\alpha = -1.40 \pm 0.11(\text{stat.}) + 0.06 - 0.09(\text{sys.})$ , consistent with the  $-3/2$  expectation for a non-evolving population in Euclidean space. We find  $\alpha$  is steeper for high-DM events and shallower for low-DM events, which is what would be expected when DM is correlated with distance. We infer a sky rate of  $[525 \pm 30(\text{stat.}) + 140 - 130(\text{sys.})]/\text{sky/day}$  above a fluence of 5 Jy ms at 600 MHz, with scattering time at 600 MHz under 10 ms, and DM above 100 pc cm<sup>-3</sup>.

**CHIME/FRB Discovery of 25 Repeating Fast Radio Burst Sources** (The CHIME/FRB Collaboration *et al* 2023 *ApJ* 947 83 DOI 10.3847/1538-4357/acc6c1)

Abstract: We present the discovery of 25 new repeating fast radio burst (FRB) sources found among CHIME/FRB events detected between 2019 September 30 and 2021 May 1. The sources were found using a new clustering algorithm that looks for multiple events colocated on the sky having similar dispersion measures (DMs). The new repeaters have DMs ranging from  $\sim 220$  to  $\sim 1700$  pc cm<sup>-3</sup>, and include sources having exhibited as few as two bursts to as many as twelve. We report a statistically significant difference in both the DM and extragalactic DM (eDM) distributions between repeating and apparently nonrepeating sources, with repeaters having a lower mean DM and eDM, and we discuss the implications. We find no clear bimodality between the repetition rates of repeaters and upper limits on repetition from apparently nonrepeating sources after correcting for sensitivity and exposure effects, although some active repeating sources stand out as anomalous. We measure the repeater fraction over time and find that it tends to an equilibrium of 2.6–2.6+2.9% over our total time-on-sky thus far. We also report on 14 more sources, which are promising repeating FRB candidates and which merit follow-up observations for confirmation.

### Discussion and Conclusions

Fast Radio Bursts are a recently discovered astrophysical phenomena that are not well understood. This topic is very complex and extensive. This paper is an attempt to introduce this subject to interested researchers as a starting point for future investigation and research.

### Biography

Mr. Hinzl is the Founder, President, and Chief Scientist of Argent Astro Research Institute (AARI). AARI, previously known as Engineering Technology Applications, LLC (ETA) is a technical and business professional services firm established to provide high quality engineering, scientific, and business consulting, contracting, and research services to commercial, corporate, and government customers. He has a B.S. in Physics, a B.S. in Mathematics, and a B.S. in Electrical and Computer Engineering, an M.S. in Electrical Engineering, and has completed all course requirements for the Ph.D in Electrical Engineering.

Mr. Hinzl is a member of the American Association of Variable Star Observers ([AAVSO](#)) where he is the observing section leader for the AAVSO International High Energy Network ([HEN](#)). The HEN is dedicated to the study of high energy astrophysical phenomena in the universe, including Gamma Ray Bursts, Quasi-Stellar Objects, Active Galactic Nuclei, and gravitational waves. He is also a member of the American Astronomical Society (AAS) and the Society for Astronomical Sciences (SAS). He has written several research papers for the AAVSO and the AAS, including:

“Data Mining Analysis for Eclipsing Binary TrES-Cyg3-04450”, D. Hinzl. The Journal of the American Association of Variable Star Observers, JAAVSO Volume 43, 2015.

“Unmanned Aerial Systems for Variable Star Astronomical Observations”, D. Hinzl. The Journal of the American Association of Variable Star Observers, JAAVSO Volume 46, 2018.

[Photometric Observations of Nine High Mass X-Ray Binaries and Analysis of Potential Periodicities and Variations](#)  
2022 Res. Notes AAS 7 15; DOI 10.3847/2515-5172/acb5a0

[Light Curve Analysis of Nine Algol \(EA\) Eclipsing Binaries Discovered During the Dauban Survey](#) 2022 Res. Notes  
AAS 6 231; DOI 10.3847/2515-5172/ac9d9e

[Light Curve Analysis of Nine Algol \(EA\) Eclipsing Binaries Discovered During the Dauban Survey-additional Data](#)  
2022 Res. Notes AAS 6 239; DOI 10.3847/2515-5172/aca28f

Contact: [argentastro22@gmail.com](mailto:argentastro22@gmail.com)

## Observation Reports

**Title:**

**Observing Report: Mapping the galactic arms of the Milky Way in hydrogen when the observer has minimal knowledge of radio equipment and electronics and a very limited budget October and November 2023.**

**SARA Observing report for SARA Journal 22/11/2023**

**Author:**

Dr Andrew Martyn Thornett  
M6THO

**Location:**

Lichfield Radio Observatory (LRO)  
Lichfield, England, United Kingdom

**Affiliations:**

- Rosliston Astronomy Group
- Astronomical Society of Penang
- British Astronomical Association Radio Astronomy Group
- Society of Amateur Radio Astronomers

**Contact email:**

[andrew@thornett.net](mailto:andrew@thornett.net)

**Website:**

<https://www.astronomy.me.uk>

Where further details of this project can be found

**Title:**

Observing Report: Mapping the galactic arms of the Milky Way in hydrogen when the observer has minimal knowledge of radio equipment and electronics and a very limited budget October and November 2023.

## Body of article:

Historically, radio astronomy was the domain of amateurs with a background in electronics, engineering or amateur radio. They built their own equipment of modified equipment designed for other purposes and achieved remarkable results in a wide range of areas.

With the development of cheap commercially available radio astronomy equipment aimed at the amateur market, it is now possible to explore a wide range of areas relevant to radio astronomy for minimal cost, and without possessing a great deal of knowledge or experience in the area.

I am a novice radio astronomer with little experience in the area, and what experience I have has had little success. I am based in the UK at latitude 52.6 degrees north and longitude 1.8 degrees west.

Amateurs have historically observed hydrogen in the Milky Way and mapped its structure, although this often involves the use of large dishes over 2m in diameter and handmade electronics and filters, which is over-putting to newcomers with limited experience in the area (such as Hydrogen Line, British Astronomical Association [https://britastro.org/section\\_information\\_/radio-astronomy-section-overview/radio-astronomy-basics/hydrogen-line](https://britastro.org/section_information_/radio-astronomy-section-overview/radio-astronomy-basics/hydrogen-line))

This observing report describes my experience of building a small hydrogen line radio telescope to map the Milky Way Arms, and successfully obtaining a reasonable map, from a highly RF-polluted area in the middle of a town, with very little knowledge or understanding of electronics or radio equipment.

I come from a background in observational astronomy and astrophotography. In the past, I have tried to detect meteors by radio scatter and Sudden Ionospheric Disturbances from the impact of solar flares on the Earth's ionosphere using equipment built by the United Kingdom Radio Astronomy Association (UKRAA) and using a Stanford Solar Centre SuperSID monitor. However, I have never tried hydrogen line work, and my attempts in the other areas had limited success! I completed the foundation amateur radio exam in the UK and am proud of my achievement, but this foundation course only covered the basics of using amateur radio equipment and the legal aspects of amateur radio communication in the UK. Unfortunately, it did not look at details of the electronics nor building my own equipment.

I found the SARA Scope in A Box project online while looking for something else (Scope in a Box, Society of Amateur Radio Astronomers), which is based on a project using the RTL-SDR Software Defined Radio Dongle (Cheap and easy hydrogen line radio astronomy with an RTL-SDR, Wifi parabolic grid dish, LNA and SDRsharp, RTL-SDR.COM). I contacted Lester Veenstra for advice on how to get started and he sent me the list of components to source locally in the UK and gave me access to the Scope on A Box software archive, and supported me through process of constructing the kit.

The Scope in a Box package uses a cheap 60x100cm mesh dish tuned to 1.7GHz, RTL-SDR V3 software defined radio, Nooelec+ H1M 1420MHz filter and cascaded amplifier, and various connectors and wires, all of which I could obtain for around £200. Initially, I used SDR Sharp software with IF Average plug in, which worked well (note that the version of SDR Sharp included in the Scope in Box software package works better than the current version of SDR Sharp). I was then introduced to Ted Cline's ezRA set of Python programmes (ezRA Free Suite of Astronomy Software, Ted Cline), and discovered the I could easily generate meaningful data from my observations using this suite. This software takes all the difficult work out of the processing of data, and allows amateurs with no knowledge of programming and minimal knowledge of processing radio astronomy data to generate a large range of amazing plots exploring the data in detail.

I was fortunate enough to be given an ex-military Ptarmigan Triffid dipole array which covers 1420MHz (UK Military Band 3). This passed the "Home Life Partner test". For a newcomer to radio astronomy, this is one of the most important tests of any equipment - will your life partner give you permission to erect it in your garden and keep it there long term? My wife did not like the look of a dish but was happy with the array which looked like anything but a radio telescope!

I built my own wooden table frame to mount it, and used some wooden strips at two ends with holes drilled at intervals to allow the elevation to be varied. My aim was to record my own map of galactic hydrogen in the Milky Way and hopefully to map out the arms of the Milky Way (Galaxy Map – Mapping Hydrogen). My first mapping exercise has now been completed and involved 6 elevation positions from 90 degrees (Zenith) to 33 degrees, pointing close to due south. EzRA suite will account for coordinates of the system in its analysis and combine data over multiple days and nights.

I collected data for 48 hours at each elevation point.

I have tested the new Nooelec 1.4GHz 60x100cm mesh dish which is readily available online (unlike the Ptarmigan array) and found this gives a good detection of the hydrogen peak at 1420.405MHz, and a readily accessible alternative to making your own antenna, for those observers, like me, with limited knowledge of antenna construction.

#### **Results of hydrogen mapping of Milky Way:**

*Plot showing my data (green plots) superimposed on radio map of Milky Way developed from professional sources (ezRA software suite)*





## Where do I go from here?

My next step is to improve resolution and turn the relative though 180 degrees to capture another 90 degrees of sky. I intend to try to get closer to 0 degrees elevation and to collect more data at existing data points to improve signal to noise ratio.

I would like to record the galactic rotation curve to demonstrate the likely existence of dark matter for myself.

I also intend to attempt to build an interferometer to record interferometry fringes whilst observing the Sun is ongoing cheap over the counter components and two dishes <1m in size.

## References:

ezRA Free Suite of Astronomy Software, Ted Cline. <https://github.com/tedcline/ezRA>

Cheap and easy hydrogen line radio astronomy with an RTL-SDR, Wifi parabolic grid dish, LNA and SDRsharp, RTL-SDR.COM. <https://www.rtl-sdr.com/cheap-and-easy-hydrogen-line-radio-astronomy-with-a-rtl-sdr-wifi-parabolic-grid-dish-lna-and-sdrsharp/>

Galaxy Map – Mapping Hydrogen. <http://galaxymap.org/drupal/node/202>

Hydrogen Line, British Astronomical Association. [https://britastro.org/section\\_information\\_/radio-astronomy-section-overview/radio-astronomy-basics/hydrogen-line](https://britastro.org/section_information_/radio-astronomy-section-overview/radio-astronomy-basics/hydrogen-line)

Scope in a Box, Society of Amateur Radio Astronomers. <https://www.radio-astronomy.org/node/366>

## Unintentional Observations of a HAARP Experiment

Whitham D. Reeve



At least one of the experiments at the HAARP facility near Gakona, Alaska during the November 2023 research campaign coincided with the daily operating schedule of the Callisto solar radio spectrometers in Alaska. The spectrometers are located at the HAARP Radio Observatory, HRO, about 1 km from the HAARP Ionospheric Research Instrument (IRI), Anchorage Radio Observatory, ARO, 290 km southwest of HAARP and Cohoe Radio Observatory, CRO, 400 km southwest of HAARP. HRO and CRO each use an active LWA Antenna with circular polarizations and ARO uses a rotatable log periodic dipole array with horizontal polarization. The experiment itself is briefly described later.

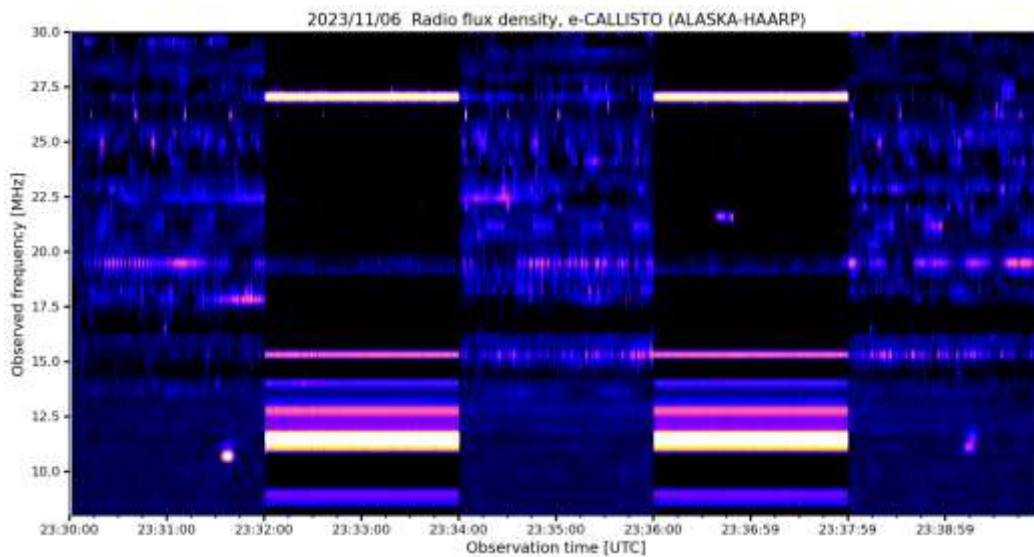

Figure 1 ~ The 2-minute On/2-minute Off cycle of the IRI is clearly seen in this 10 minute spectrogram. The responses of the Callisto spectrometer and antenna Front End Electronics were grossly nonlinear due to their close proximity to the powerful IRI. Image courtesy of Christian Monstein

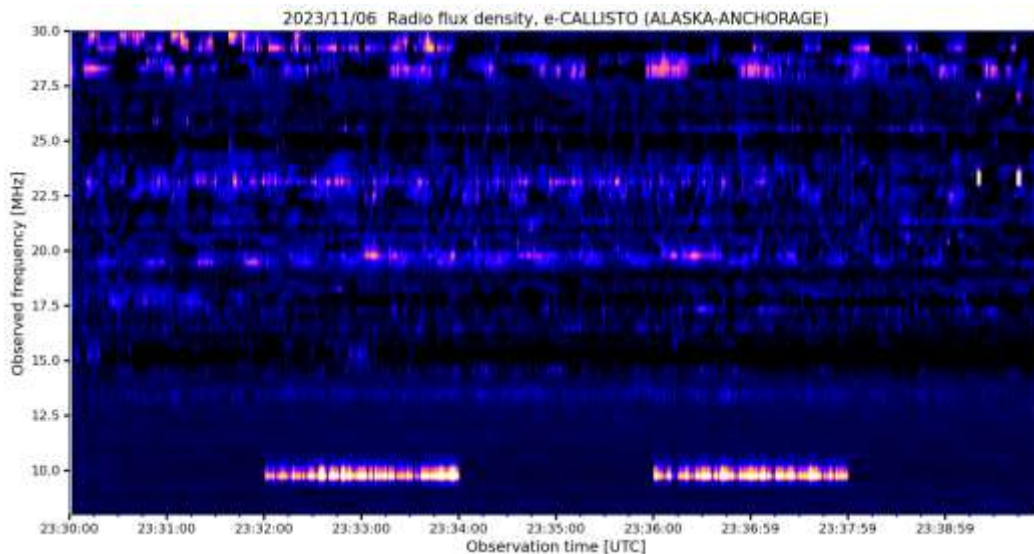

Figure 2 ~ The spectra at ARO (290 km distant) was relatively normal compared to HRO, showing only the 8.1 MHz fundamental (seen near 10 MHz due to a plotting limitation). The weak trace at 20 MHz in this and previous image may be the time-frequency station WWV or WWVH. Image courtesy of Christian Monstein

The IRI is an extremely powerful transmitter that operates from 2.7 to 10 MHz while the Callisto instruments with an up-converter operate from 5 to 85 MHz. The proximity of the HRO Callistos and associated active antenna led to severe overload and nonlinear operation that are evident in the spectra, which shows several harmonics of the transmitted frequencies (figure 1). The ARO Callistos are farther away and apparently experienced no ill-effects (figure 2) but those located at CRO also showed nonlinear operation (figure 3), possibly due to overload of the Front End Electronics in the antenna. Note that the low end of the frequency scales in all plots is inaccurate due to a limitation in the Python plotter library used to produce these images.

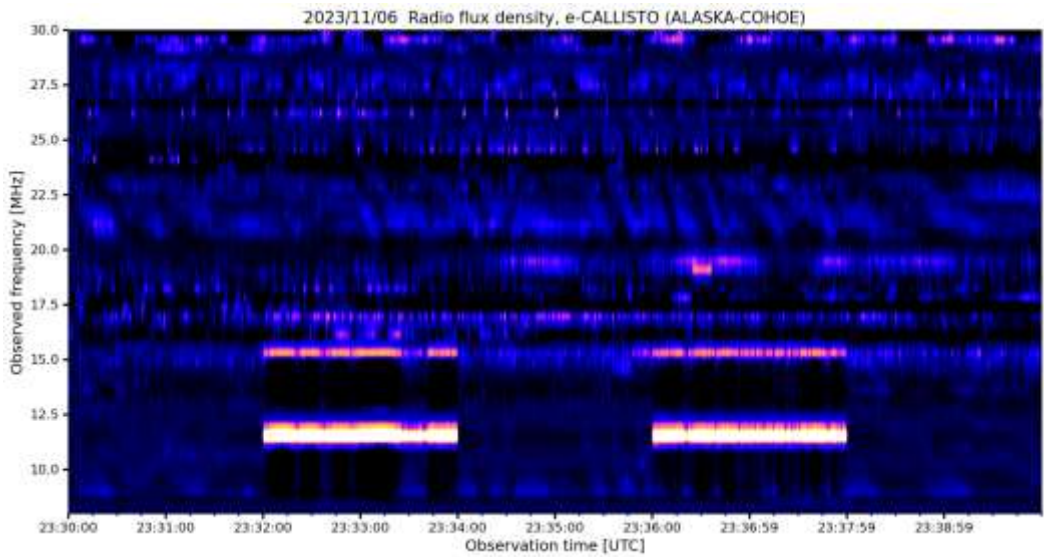

Figure 3 ~ The Callisto instrument at CRO (400 km distant) appears to show some overload that caused the bright traces between 10 and 12.5 MHz and somewhat weaker traces slightly above 15 MHz. The fundamental at 8.1 MHz is not visible. Image courtesy of Christian Monstein

The HAARP experiment on 6 November 2023 that produced the above spectra consisted of splitting the IRI antenna array and transmitting 3.25 MHz on one half and 8.1 MHz on the other half. Both beams used circular polarization but with opposite rotations. The unmodulated 8.1 MHz pencil beam was pointed almost vertically along the local magnetic field lines (magnetic zenith, about 14°). It was designed to excite the E-region ionosphere above the HAARP facility to produce field-aligned highly conductive plasma that acts like a low frequency antenna. The 3.25 MHz carrier pencil beam was pointed vertically and was modulated with a low frequency linear ramp, snake-like ramp and amplitude shift keying (ASK) waveforms to induce low frequency emissions from the enhanced conductive region. The experiment produced the desired emissions as did an almost identical experiment the day before (figure 4).

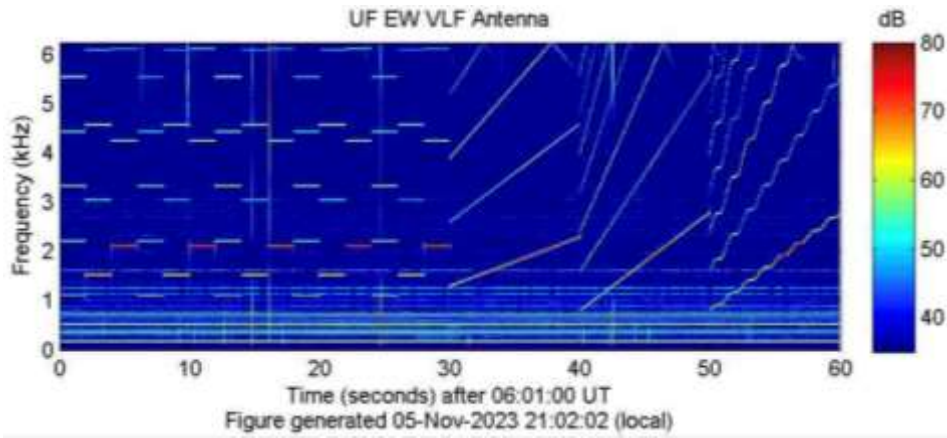

Figure 4 ~ HAARP induced ULF and VLF emissions received at Chistochina about 30 km northeast of HAARP on 5 November from a similar experiment. Acknowledgements: Robert Moore – University of Florida for ELF Receiver & Mark Golkowski – University of Colorado for the experiment sequence

## AD8302 Interferometer Results

By Mike Otte  
Otte Observatory  
42.2N 89.9W  
mike.otte96@gmail.com

I became familiar with the AD8302 module after reading about the 1.2M interferometer at Astropeiler Stockert. I got the data sheet and found them on eBay to be very inexpensive. Ordered a handful.

AD8302 compares two signals and gives a magnitude (Dbm) and phase (0-180) outputs. They operate up to 2.7Ghz so no down converter is necessary for the 1420Mhz band. They have calibrated outputs if the signals are above -60DBm and the outputs are biased at 900mv.

My first attempt was in 2022 using an old DAQ box hooked right to the AD8302 module which was hooked to the 2 x 3M dishes. All I saw was hash even during a Solar transit.

Flash forward to September of 2023 and I saw Jan Lustrup was having success with 2 x 1.7M dishes and the AD8302. So, I tried again and am very happy with the results.

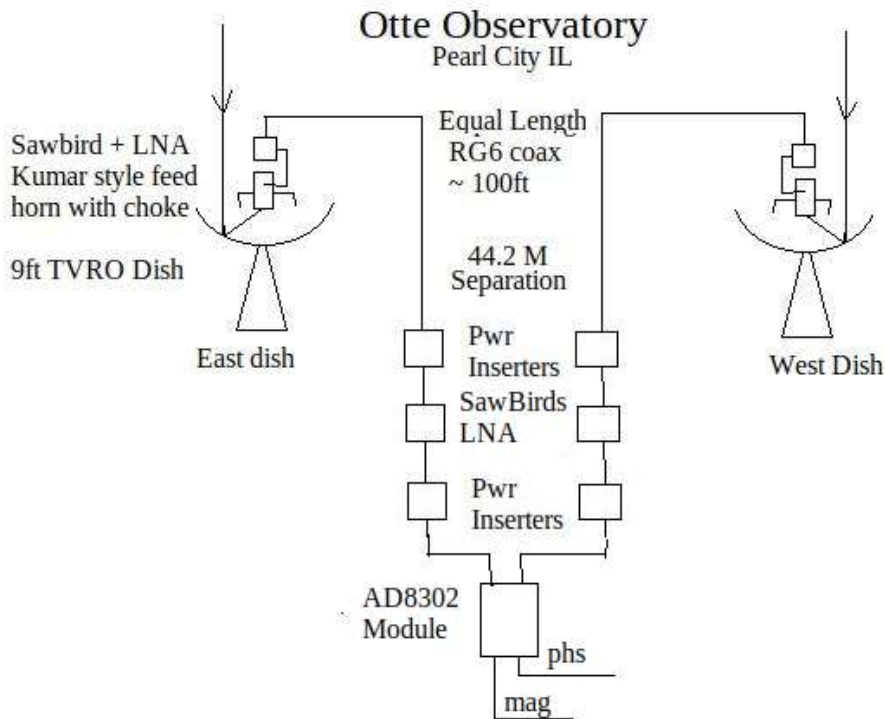

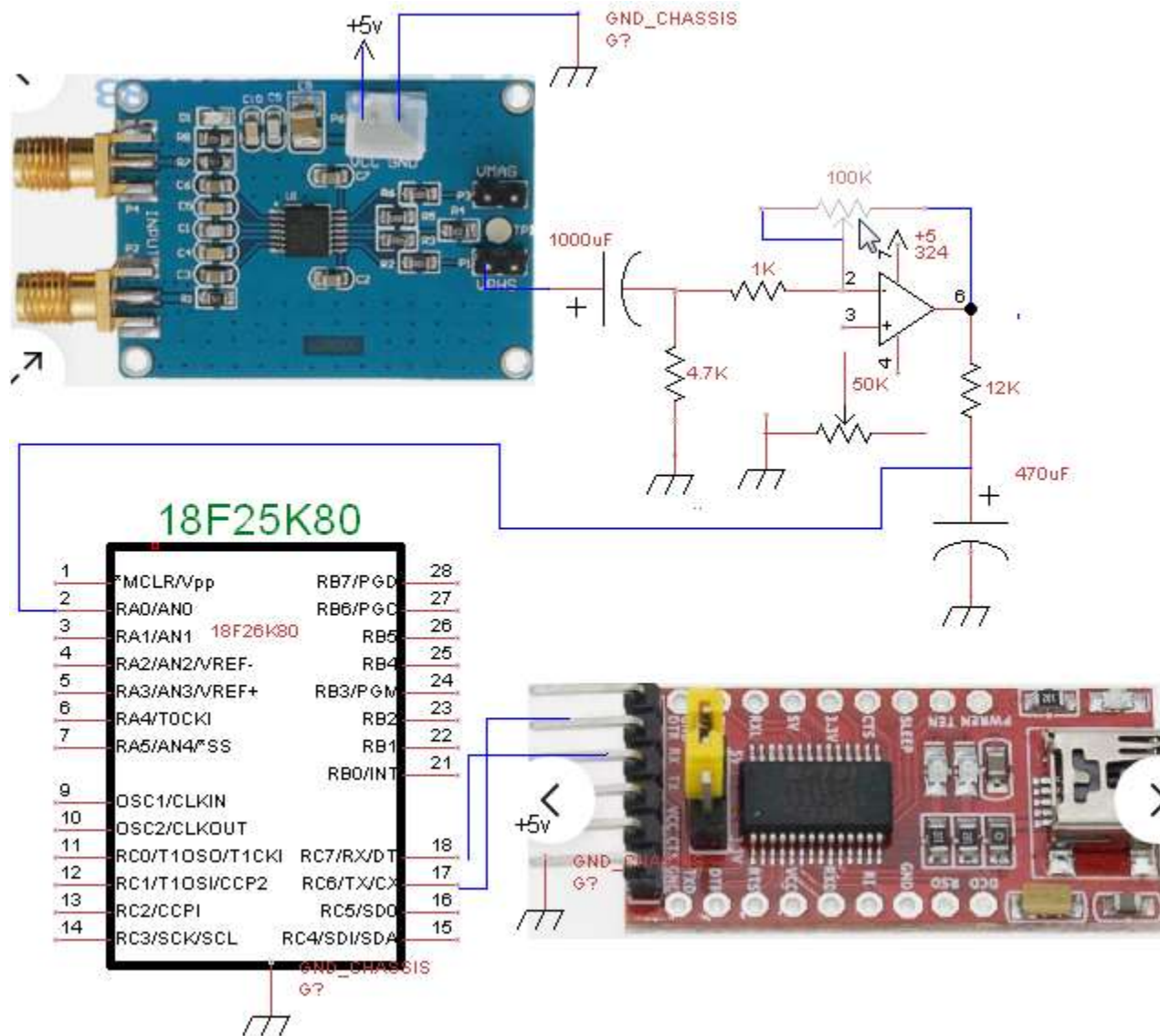

I tried to use the AD8302 without the additional OP Amp used by Jan Lustrup but the A/D would only move 1 or 2 bits. Not much resolution. The AD8302 is designed for signals down to -60dBm. To get up to this level I used 2 sawbirds on each leg of the interferometer. Then I could detect more than the Sun but the phase output would still only deviate 1 or 2 bits on the 12 bit A/D. Also, the phase detector glitches plus and minus constantly without a signal. Next, I added a large capacitor to ground on the A/D input to the microcontroller and isolated it with a 12K resistor. This smoothed out much of the glitching. Then to increase the small output signal I used Jan's circuit with an OP Amp to multiply the signal. I have the gain set about halfway. The series capacitor acts as a blocking capacitor and passes interferometer signals that look like sine waves.

Radio telescopes have multiple purposes. The sdr ones can measure strength and spectrum. Strength is not repeatable because of many variables including temperature. Spectrum is great for measuring velocities of specific gases like hydrogen. The AD8302 interferometer measures strength and phase. Interferometers were first used to find radio sources in the cosmos and associate them with something you could see with an optical telescope. What were these radio sources? So, an interferometer makes positional measurements. Three common numbers

that come out of the measurement are Fringe period (or frequency), “visibility” = amplitude of the fringe, and of course the time of the sample which gives our RA.

Some minor math:

Resolution of the interferometer in radians =  $1.22 \cdot \text{wavelength} / \text{baseline}$

for the 3 M dish:  $1.22 \times .21 \div 3 \times 57.3 = 4.89 \text{ deg}$

for my interferometer with baseline of 44.2 M:  $1.22 \times .21 \div 44.2 \times 57.3 = 0.33 \text{ deg}$

Fringe rate =  $\text{Baseline} / \text{wavelength} \cdot \text{angular rotation of earth} \cdot \cos \text{declination}$

Fringe period =  $(44.2 \text{ M} / .21 \text{ M} \cdot 7.3 \times 10^{-5} \cdot \cos 40)^{-1} = 84.96 \text{ sec}$

Visibility is treated later.

#### Source List

Source			RA	Dec	Flux	Fringe P
Cas A	W81	3C461	23:23	58:48	2240	126.4
Cyg A	W57	3C405	19:59	40:44	1255	85
Tau A	M1	3C144	05:34	22:00	926	70.2
NRAO608	W51	3C400	19:23	14:06	710	67.1
Virgo A	M87	3C274	12:30	12.3	198	66.5
Herc A		3C348	16:51	5		65.3
Orion A	W10, M42	3C145	05:35	-05:25	520	65.3
NGC6618	W38		18:20	-16:10	1060	67.7
Sag A	W24		17:45	-27	3650	73
Sun				-22.5		70.2 sec

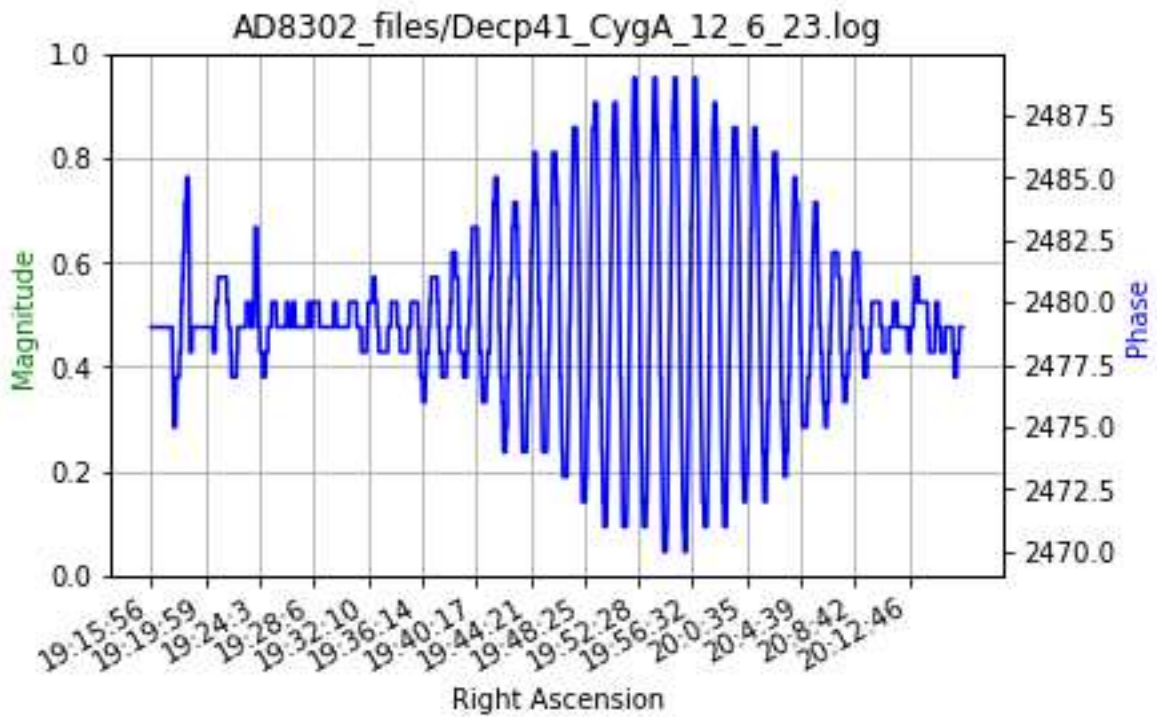
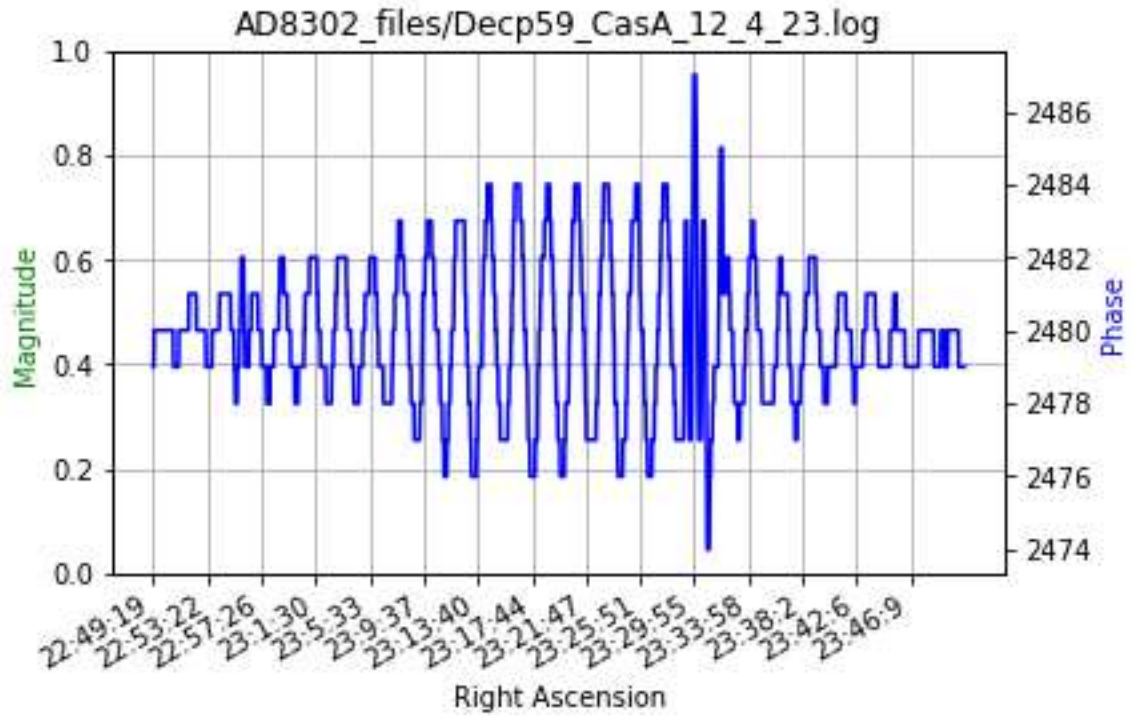



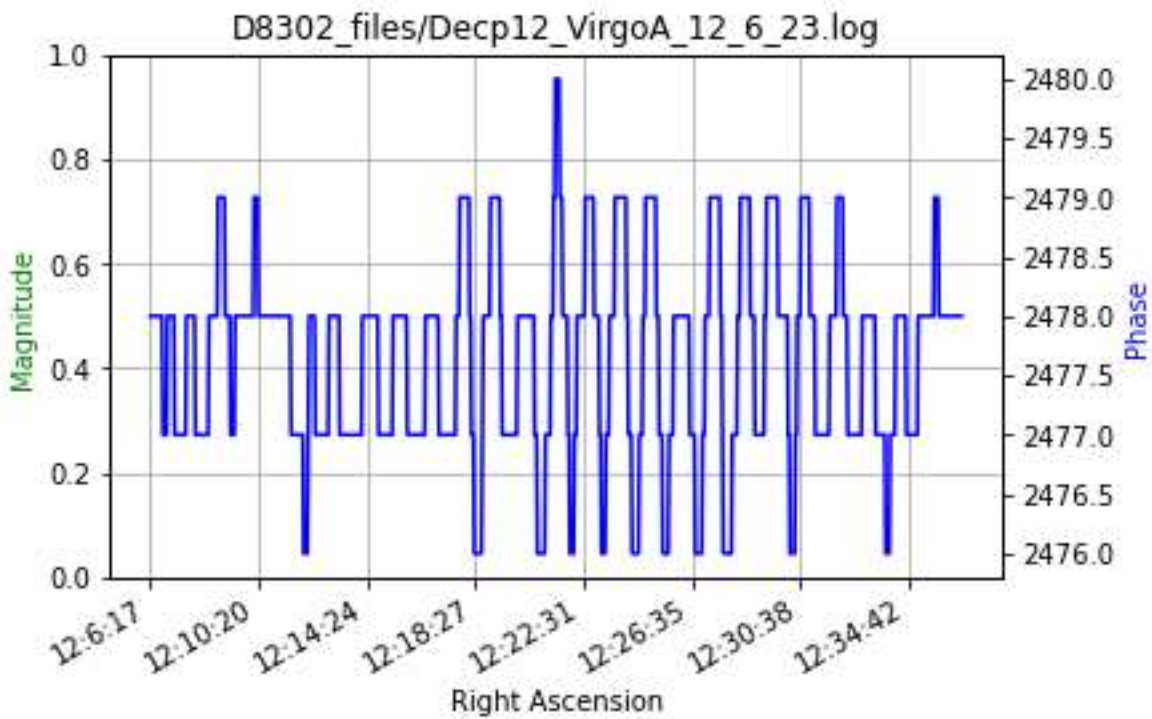
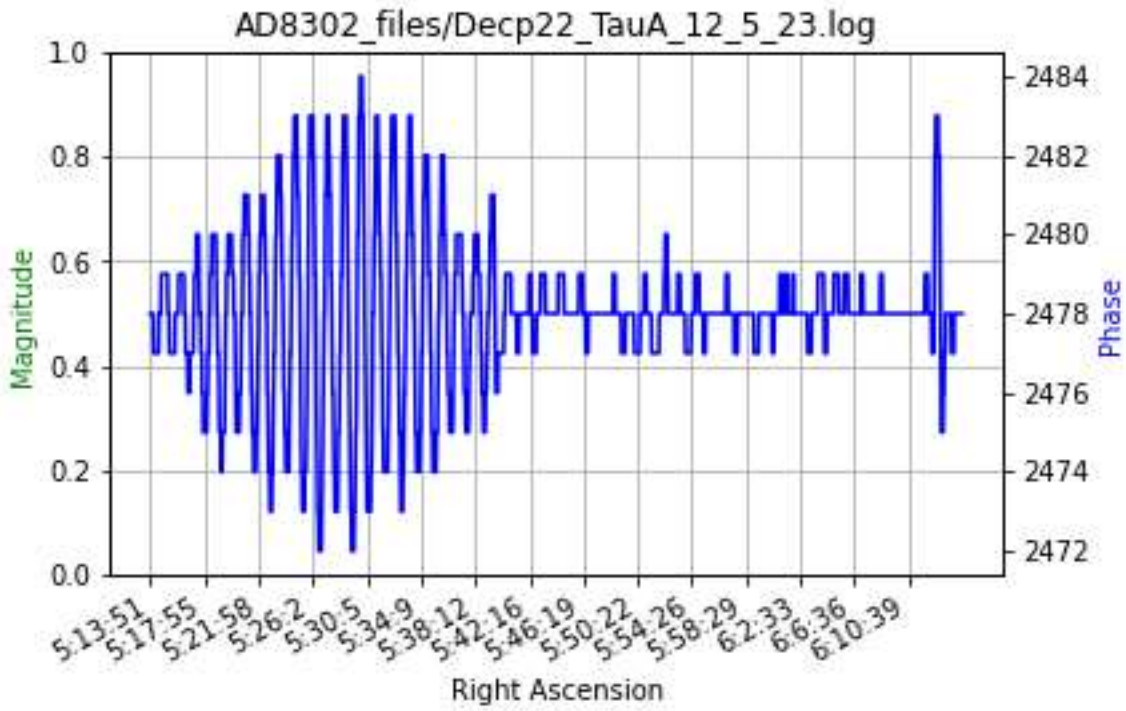

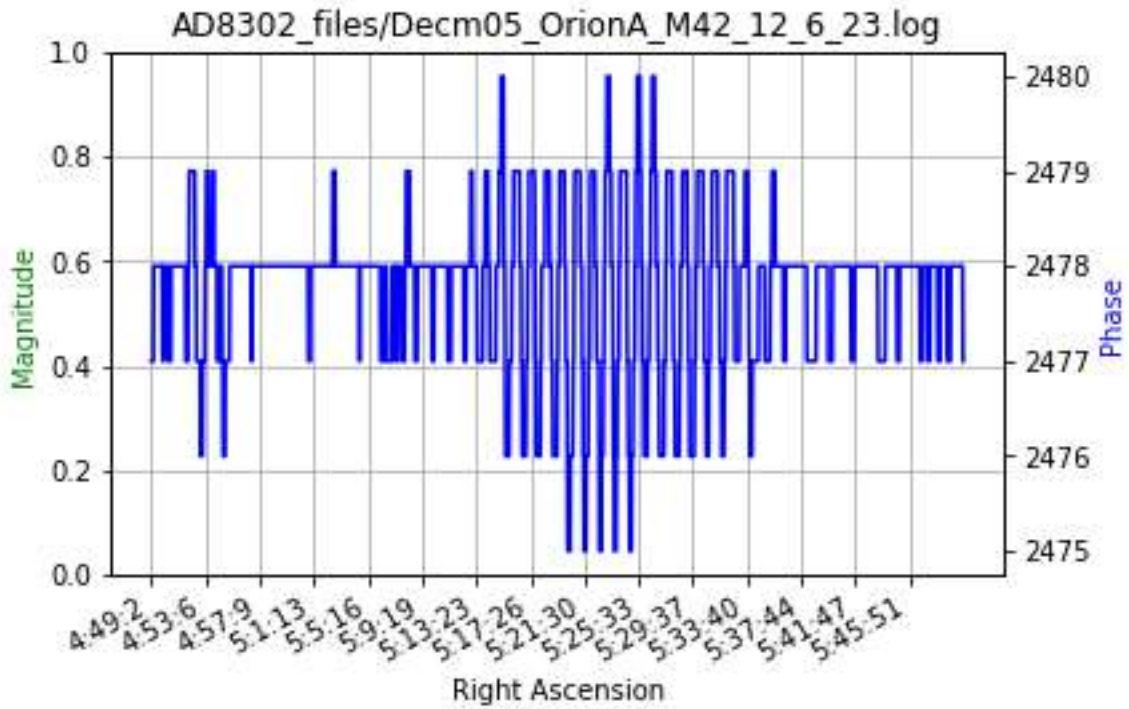
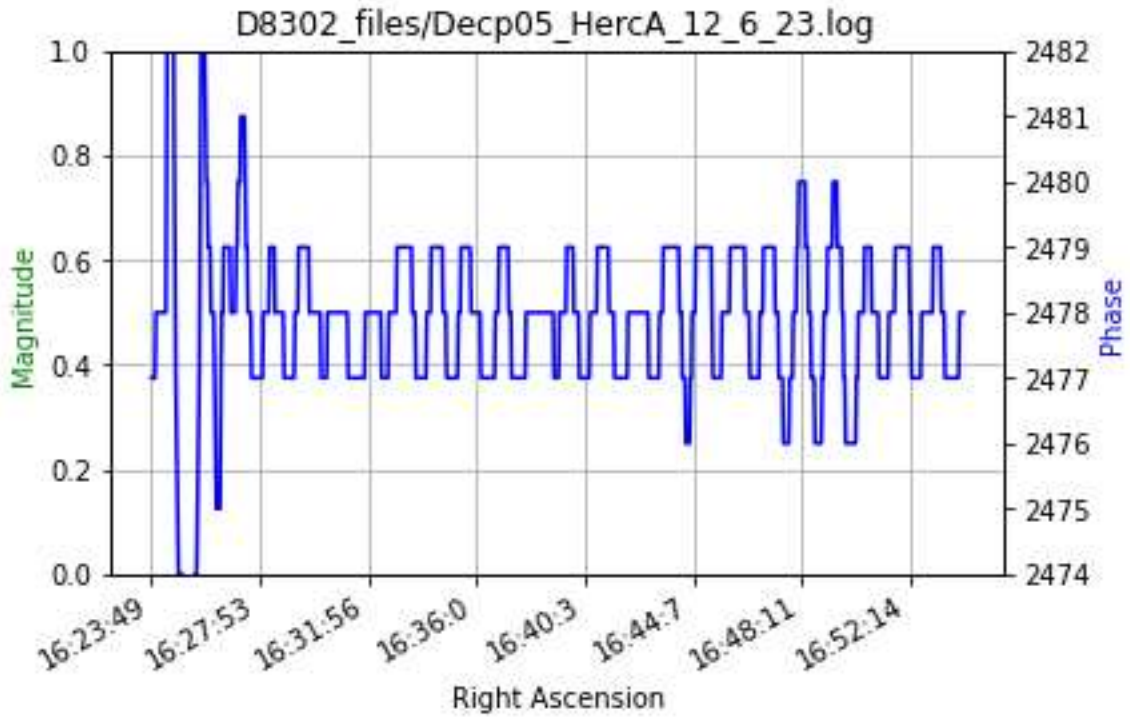

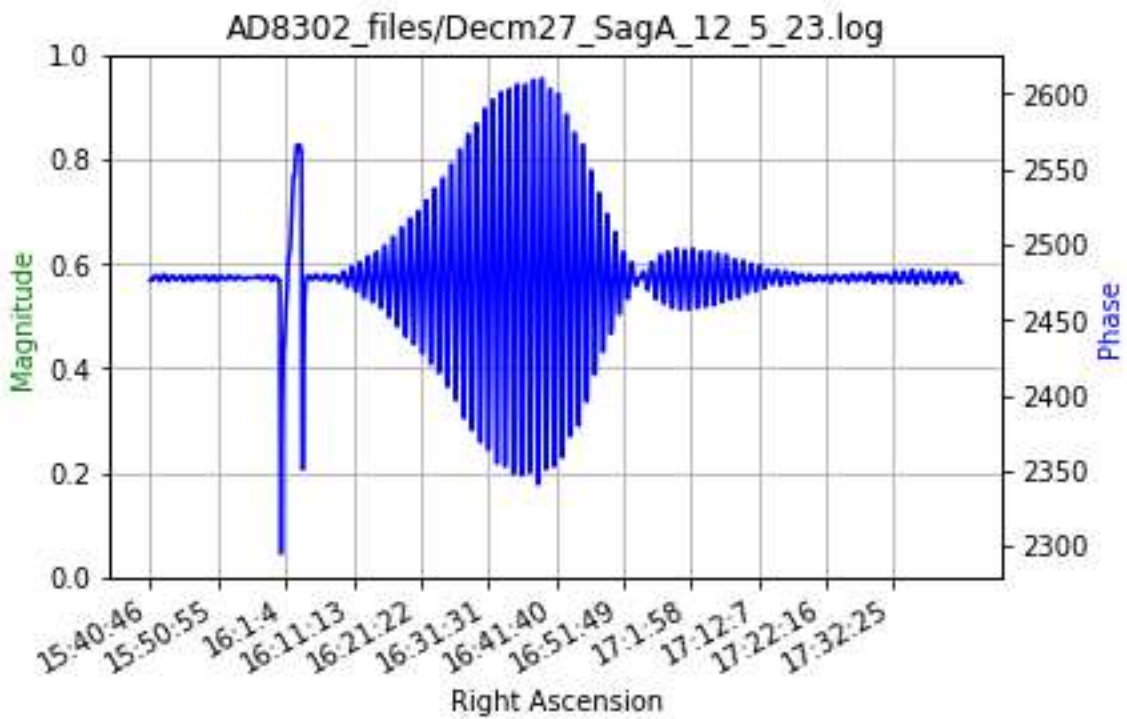
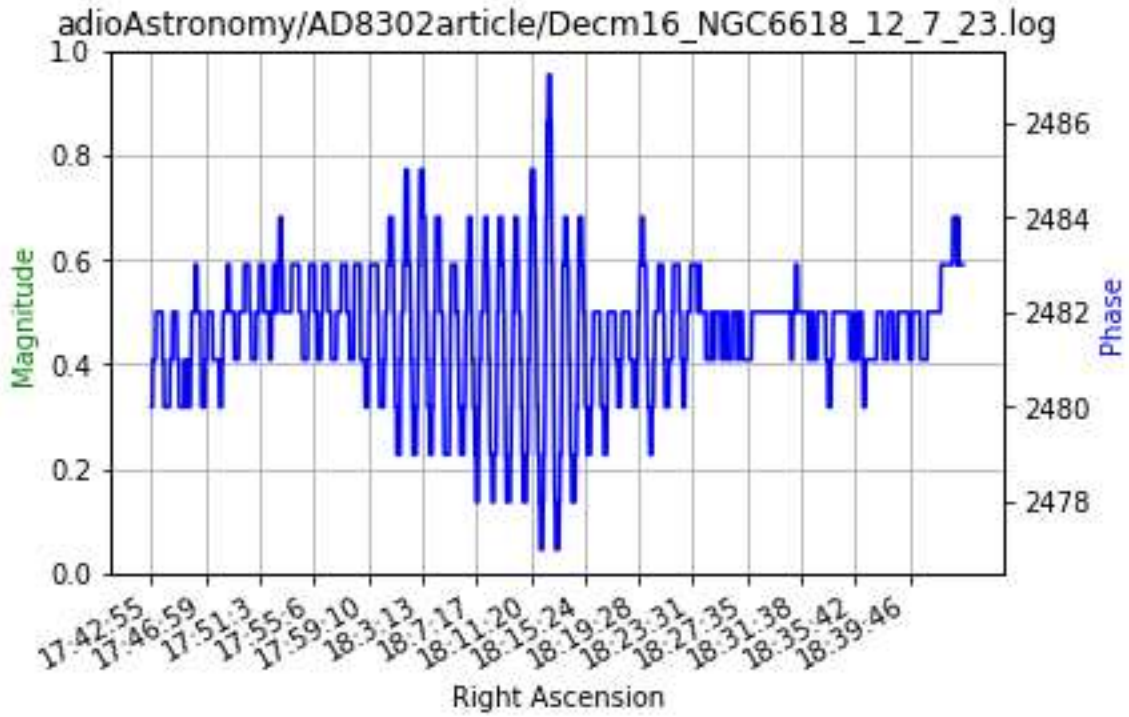

This last one is a combination of the Sun and Sagittarius A. The Sun was coming into Sagittarius and was at -23 Declination. Sag A is at -27 declination. The beam width of the dishes is ~5 deg. Also, the Sun is so strong that it shows up in things 30 deg away.

#### Visibility

Source	A/D counts = amplitude	Reference Flux
Sun	270	
Sag A	45	3650
Cas A	8	2240
Cyg A	19	1255
Tau A	12	926
Virgo A	3	198
Herc A	2	39
Orion A	4	520
NGC6618	8	1060

The reference flux may not be representative of the wider band magnitude that the AD8302 is measuring.

Also, I can't remember if I turned up the gain on the op amp after the Cas A measurement? I'll check my notes, smile.

#### Improvements:

I would make the sample time clock more accurate. Right now, it runs off of the PIC's internal processor clock and if I set it every day it is within 30 - 45 secs, Not great.

The op amp makes this work. Gain is needed. So more "tuning" of the capacitors and timings.

A stable power supply would be good. Right now, the AD8302, the op amp and the Microcontroller all run off the 5vdc from the usb to serial converter. (lots of caps)

The A/D sampler could record the samples on to a thumb drive instead of sending the samples to a PC/terminal for logging into the file.

Another problem is that I live in the hills and my east dish is 11 ft lower than the west dish. That is almost 3 degrees towards the east. So, the sources show up several minutes too soon. Actually, not a problem for the AD8302 but you'll see it in my charts above.

## Conclusion:

The Ad8302 interferometer is quite capable of doing Interferometry for the amateur radio astronomer. You don't need a B210 for \$1000 but you do need double sawbirds on both antennas. Also, a little soldering on the op amps and A/D circuit.

## References:

Jan Lustrup on Facebook "Amateur Radio Astronomy"

<https://www.facebook.com/groups/1819174114777651>

Astropheiler Stockert

<https://www.astropheiler.de/en/info-zum-2-x-12-meter-interferometer/>

**Observation Report: Basic Survey of H1 Using Amateur Pyramidal Horn Antenna**  
**Nathaniel Butts - SOKYRAD**

**Abstract**

This is an observation report on my first H1 full-sky survey. All measurements were done with my homebuilt, pyramidal horn antenna using material easily sourced at common home improvement stores. The data for this report has been collected and processed using ezRA, along with guidance from Ted Cline.

**Equipment and Setup**

A pyramidal horn (Figure 1) with rectangular waveguide was constructed from common construction materials purchased at a local improvement store (Lowe's).

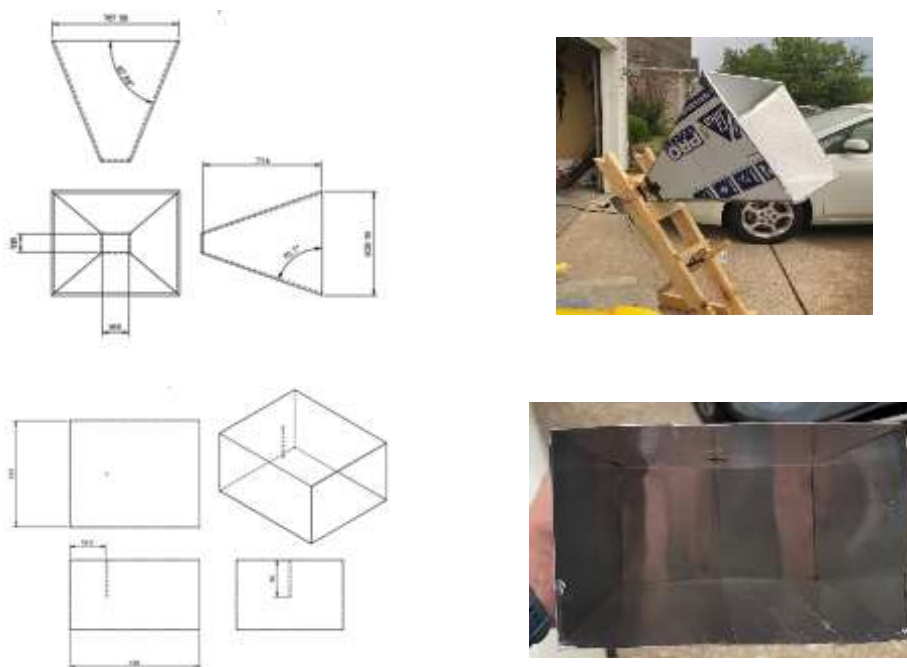

*Figure 1: Dimensions and Photos of Antenna*

The horn was assembled using 2" conductive, aluminum tape and the waveguide was assembled using a combination of metallic bonding agents and aluminum tape. A copper wire was cut to length and soldered to an SMA panel mount connector. In total, the equipment was:

- Pyramidal Horn
  - 0.45m<sup>2</sup> collecting area
- Galvanized steel waveguide
  - 52.5mm Copper Feed
- Nooelec NESDR SMARt V5
- Nooelec SAWbird H1+ LNA
- Raspberry Pi 4 8gb

The software used for this survey consisted of:

- ezRA - Easy Radio Astronomy <https://github.com/tedcline/ezRA> [1]
- Python 3.9
- Raspberry Pi OS 11

The survey was performed at my home in Bowling Green, KY (Lat 36.9309, Long -86.4316), 171m above sea level. Measurements were performed at Elevations between 25-90°, changing 2.5° of elevation daily, and were repeated at 180° and 325° Azimuths. Continuous drift scan technique was used with the software set to take 186,000 readings integrated into each recorded sample, for approximately 0.24° of sky per sample.

### Analysis

First, we plot the map of Neutral Hydrogen in the galaxy. This is plotted in two ways: Figure 2 plots Right Ascension across the horizontal axis, and Declination along the vertical. Figure 3 plots the same data in a Mercator format, using Galactic Coordinates. This enables showing ±90 degrees galactic latitude and ±180 degrees longitude in one plot.

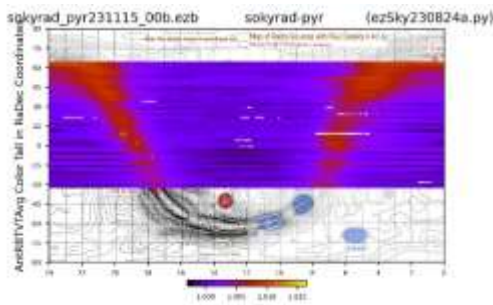

Figure 2: RaDec Plot

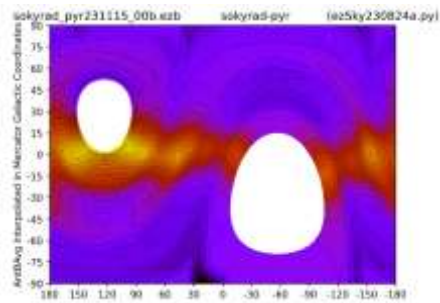

Figure 3: Mercator Plot

The white areas in the Mercator are points in the sky not visible from my location. Figure 2 clearly shows the galactic hydrogen, and it is plotted against known radio sky maps for comparison. The data shows some striations in some elevations, due to a change in the waveguide construction part way through the survey.

Figure 4 shows possible galactic hydrogen plotted as distances from galactic center. The green dot is the galactic center, yellow dot is the sun's location. You can clearly see larger structures in the galaxy with this data, and I've overlaid it with the NASA/JPL rendering of the galaxy (Figure 5) for comparison. The colors are a heat map of the relative power of the received data.

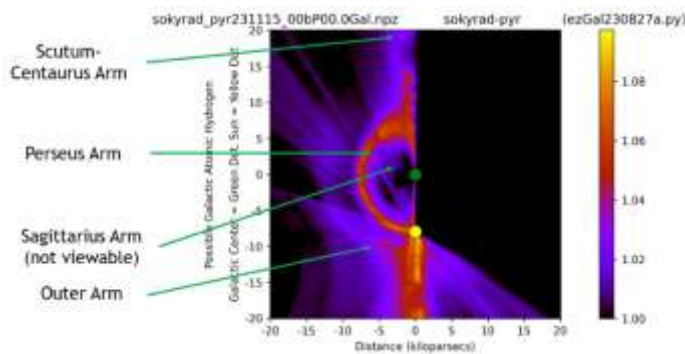

Figure 4: Distance from Galactic Center

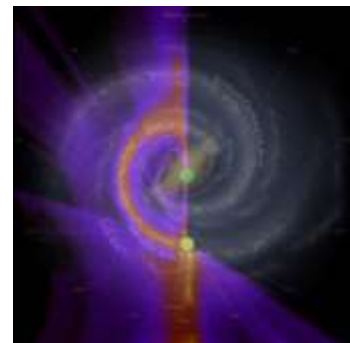

Figure 5: Overlay

With the ezRA software, we are now able to interpolate the velocities of the gases in the galaxy for distances relative to our position. This gives us the ability to analyze how fast different parts of the galaxy are rotating. Figure 6 shows this velocity of the galaxy in all measurable galactic longitudes and latitudes.

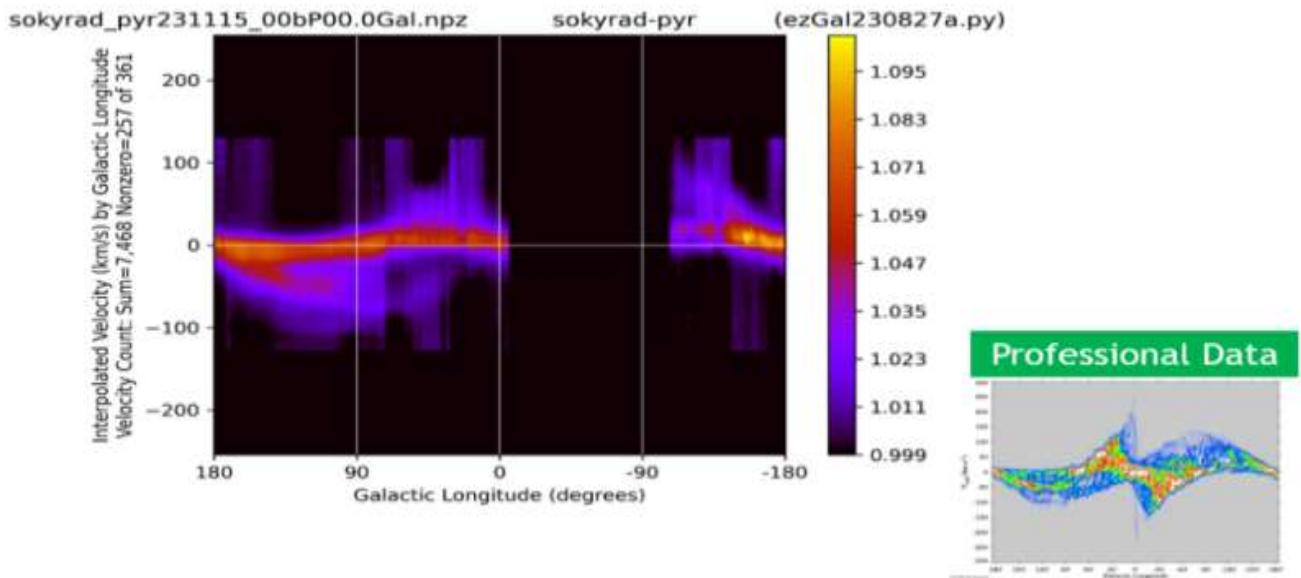

Figure 6: Velocity vs. Gal. Longitude (Professional data [2])

Using this data, I was able to calculate (with ezRA) the velocities up to the distance of the sun to the center of the galaxy (8 kpc) away. My calculated value was 234 km/s (Figure 7), while the professionals measured 220 km/s.

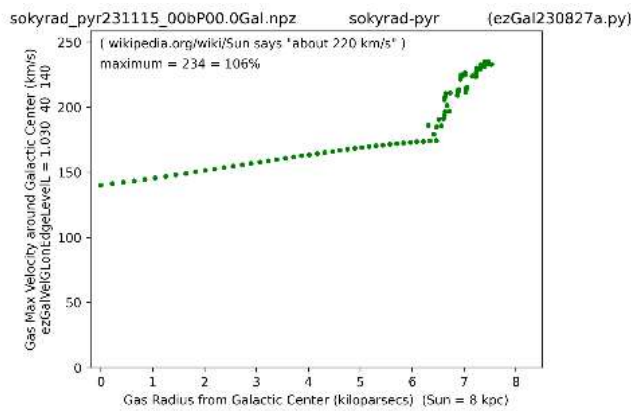

Figure 7: Calculated Gas Velocity

Now that we have distances and velocities, we can calculate the theoretical mass of the galaxy (Figure 8). My data ( $1.03 \times 10^{13}$  Solar Masses) is within 3% of the measured value of  $1.15 \times 10^{12}$  Solar Masses provided by Kafle, Sharma, Lewis, Bland-Hawthorn [3]



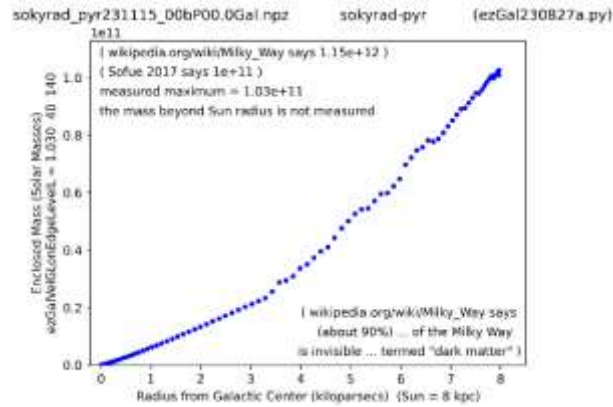

Figure 8: Calculated Galactic Mass

This also correlates with other astronomers' findings that the velocity of the galactic rotation does not follow Keplerian motion and points to there being more mass in the galaxy than we can physically "see".

Dr. Angela Collier, "Dark matter is not a theory, it's a list of observations showing missing mass." - <https://www.youtube.com/watch?v=PbmJkMhmrVI>

ezRA provides hundreds of plots to help analyze and discover aspects of our galaxy hidden in the radio spectrum. Even the historical Longitude over Velocity line charts (Figure 9) show the relative velocities of different parts of the galaxy, in ways easily understandable by the novice and professional astronomer.

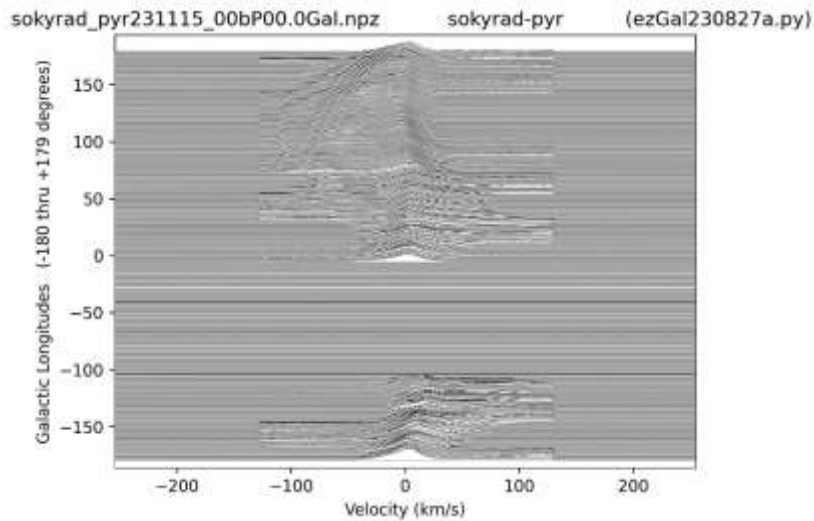

Figure 9: Spectrograph per Galactic Longitude vs. Velocity

### Next Steps

From here, my future plans are to start learning how to calculate and plot the distribution of HI per galactic longitude, in order to better determine the velocity and mass used in rotational modeling, as well as visual plots of the structures in the galaxy.

Thank you for making it this far.

I would like to thank everyone at SARA for making my first sky survey a success. I believe what I've learned from this adventure will be good lessons for future observations, from which I can build better data.

I would also like to let all future, Wannabe Astronomers, know that this is easily doable with less than \$300 of total expenses, can be built in your garage/patio, and can be performed even in urban areas like where I live. There are a host of other "off the shelf" software dedicated to SDR concepts for Radio Astronomy that are accessible to the novice. I hope to showcase their abilities in the near future. RA is a journey and is meant to be enjoyed. I hope my paper helps others discover the joys to be had.

### References

- [1] T. Cline, Easy Radio Astronomy <https://github.com/tedcline/ezRA>
- [2] Kalberla et. Al, The Leiden/Argentine/Bonn (LAB) Survey of Galactic HI, *Astronomy & Astrophysics*, 440 2 pg 775-782 (2005)
- [3] Kafle, Sharma, Lewis, Bland-Hawthorn, "Kinematics of the Stellar Halo and the Mass Distribution of the Milky Way Using Blue Horizontal Branch Stars.", arXiv:1210.7527, (2012)



About the author: The author is a graduate of Western Kentucky University for Mechanical Engineering. He studied Physics and Astronomy where he found a love, but not a career, for Astronomy. The spark has stayed alive, and he is an avid Wannabe Astronomer, dedicated to advancing the cause of Amateur Astronomers the world over.

### **Journal Archives and Other Promotions**

The rich and diverse legacy of member contributed content is available in the SARA Journal Archives. Table of contents for journals is available online at: [SARA-Journal-Master-Index.xlsx \(live.com\)](#)

The entire set of The Journal of The Society of Amateur Radio Astronomers is available by online download. It goes from the beginning of 1981 to the end of 2022 (over 6000 pages of SARA history!)

**All SARA journals and conference proceedings are available through the previous calendar year.**

SARA Store ([radio-astronomy.org/store](http://radio-astronomy.org/store).)

SARA offers the above USB drives, DVDs, printed Proceedings and Proceedings on USB drive and other items at the SARA Store: <http://www.radio-astronomy.org/e-store>. Proceeds from sales go to support the student grant program. Members receive an additional 10% discount on orders over \$50 US. Payments can be made by sending payment by PayPal to [treas@radio-astronomy.org](mailto:treas@radio-astronomy.org) or by mailing a check or money order to SARA, c/o Brian O'Rourke, 337 Meadow Ridge Rd, Troy, VA 22974-3256

### **SARA Online Discussion Group**

SARA members participate in the online forum at <http://groups.google.com/group/sara-list>. This is an invaluable resource for any amateur radio astronomer.

### **SARA Conferences**

SARA organizes multiple conferences each year. Participants give talks, share ideas, attend seminars, and get hands-on experience. For more information, visit <http://www.radio-astronomy.org/meetings>.

## **What is Radio Astronomy?**

Radio Astronomy is just what the name implies.... Astronomy observed at radio wavelengths instead of optical. But why do radio astronomy? Radio astronomy has expanded the knowledge of the universe about as much since its discovery in 1932 as optical has since humans first looked up at the sky. (The sky in the different frequencies or colors of radio are as different and varied as all of the flowers on Earth. Each frequency has its own information about what is happening in the universe.) This knowledge has been gained by both professional astronomers as well as amateurs with amateurs contributing to this day.

### **Do I need a big dish and expensive equipment?**

No. Complete beginner projects are available at the [SARA store](#) at very reasonable prices. You can monitor the Sun's effects upon our planet with [SuperSID](#). This information is gathered for Stanford for research into our ionosphere and radio signal propagation. Another project is the detection the hydrogen line just like Dr. Ewen had done in 1951 for a fraction of the cost using the [Scope in a Box](#) kit.

That said, radio astronomy is like optical astronomy in that you can spend as much as you want to. Many amateurs push the lower boundaries of cost by using very low-cost receivers and low-noise low-cost amplifiers that were not available even a few years ago. (See the [Scope in a Box](#) kit in the store for examples of both.)

### **Is everything 'plug and play' and boring?**

The kits mentioned above are a starting point which are mostly plug-and-play... that gets you started. After you have mastered the basics, where you go from there depends upon your interests. Monitoring pulsars is done by amateurs. (One even noticed a [pulsar glitch](#) before the professionals!) These amateurs are pushing the boundaries of what can be done. Papers are being published and discussion had about pulsar detection as well detection of a MASER with a 50-inch dish. Techniques on new detection methods are posted in the [SARA forum](#) and elsewhere. You are free to build your own equipment to receive the signals as well as software to collect and analyze the data.

### **What is SETI?**

SETI is the Search for Extra-Terrestrial Intelligence. Some amateurs scan the sky and search for signals that might be from aliens. To date no one has received a definitive alien signal (professional or amateur), but the search continues. The search has resulted not just in better receiving equipment but also wide and lively discussions about how aliens might communicate and how they might be trying to contact us. Some of these techniques have interesting ideas for our own communication techniques here on Earth!

### **What should I do to get started?**

You should start with reading our [Introduction to Radio Astronomy](#) and joining our online [SARA Forum](#). Look at the [SARA store](#) to get a project to get your feet wet without much expense and minimal risk. We will work with you so you can succeed.

## Administrative

### Officers, directors, and additional SARA contacts

The Society of Amateur Radio Astronomers is an all-volunteer organization. The best way to reach people on this page is by email with SARA in the subject line SARA Officers.

President: Dr. Rich Russel, AC0UB, <https://www.radio-astronomy.org/contact/President>

Vice President: Jay Wilson, <https://www.radio-astronomy.org/contact/Vicepresident>

Secretary: Bruce Randall, NT4RT, <https://www.radio-astronomy.org/contact/Secretary>

Treasurer: Tom Jacobs, <https://www.radio-astronomy.org/contact/Treasurer>

Asst. Treasurer: Donna Hallin, <https://www.radio-astronomy.org/contact/Treasurer>

Past President: Dennis Farr

Founder Emeritus and Director: Jeffrey M. Lichtman, KI4GIY, [jeff@radioastronomysupplies.com](mailto:jeff@radioastronomysupplies.com)

### Board of Directors

Name	Term expires	Email
Ed Harfmann	2024	<a href="mailto:edharfmann@comcast.net">edharfmann@comcast.net</a>
Dr. Wolfgang Herrmann	2025	<a href="mailto:messbetrieb@astropeiler.de">messbetrieb@astropeiler.de</a>
Paul Butler	2025	<a href="mailto:paul.butler.melbourne@gmail.com">paul.butler.melbourne@gmail.com</a>
Charles Osborne	2025	<a href="mailto:k4cso@twc.com">k4cso@twc.com</a>
Bob Stricklin	2024	<a href="mailto:bstrick@n5brg.com">bstrick@n5brg.com</a>
Steve Tzikas	2024	<a href="mailto:Tzikas@alum.rpi.edu">Tzikas@alum.rpi.edu</a>
Ted Cline	2025	<a href="mailto:TedClineGit@gmail.com">TedClineGit@gmail.com</a>
David Westman	2024	<a href="mailto:david.westman@engineeringretirees.org">david.westman@engineeringretirees.org</a>

### Other SARA Contacts

All Officers	<a href="http://www.radio-astronomy.org/contact-sara">http://www.radio-astronomy.org/contact-sara</a>	
All Directors and Officers	<a href="http://www.radio-astronomy.org/contact/All-Directors-and-Officers">http://www.radio-astronomy.org/contact/All-Directors-and-Officers</a>	
Eastern Conference Coordinator	<a href="http://www.radio-astronomy.org/contact/Annual-Meeting">http://www.radio-astronomy.org/contact/Annual-Meeting</a>	
All Radio Astronomy Editors	<a href="http://www.radio-astronomy.org/contact/Newsletter-Editor">http://www.radio-astronomy.org/contact/Newsletter-Editor</a>	
Radio Astronomy Editor	Dr. Richard A. Russel	<a href="mailto:drrichrussel@radio-astronomy.org">drrichrussel@radio-astronomy.org</a>
Contributing Editor	Bogdan Vacaliuc	<a href="mailto:bvaculiuc@iee.org">bvaculiuc@iee.org</a>
Educational Co-Chairs	Ken Redcap, Tom Hagen: <a href="http://www.radio-astronomy.org/contact/Educational-Outreach">http://www.radio-astronomy.org/contact/Educational-Outreach</a>	
Grant Committee	Tom Crowley	<a href="mailto:grants@radio-astronomy.org">grants@radio-astronomy.org</a>
Membership Chair	<a href="http://www.radio-astronomy.org/contact/Membership-Chair">http://www.radio-astronomy.org/contact/Membership-Chair</a>	
Technical Queries (David Westman)	<a href="http://www.radio-astronomy.org/contact/Technical-Queries">http://www.radio-astronomy.org/contact/Technical-Queries</a>	
Webmaster	Ciprian (Chip) Sufitchi, N2YO	<a href="mailto:webmaster@radio-astronomy.org">webmaster@radio-astronomy.org</a>

## Resources

### Great Projects to Get Started in Radio Astronomy

#### Radio Observing Program

The Astronomical League (AL) is starting a radio astronomy observing program. If you observe one category, you get a Bronze certificate. Silver pin is two categories with one being personally built. Gold pin level is at least four categories. (Silver and Gold level require AL membership which many clubs have membership. For the bronze level, you need not be a member of AL.)

Categories include

- 1) SID
- 2) Sun (aka IBT)
- 3) Jupiter (aka Radio Jove)
- 4) Meteor back-scatter
- 5) Galactic radio sources

This program is a collaboration between NRAO and AL. Steve Boerner is the Lead Coordinator and a SARA member.

For more information:

Steve Boerner

2017 Lake Clay Drive

Chesterfield, MO 63017

Email: [sboerner@charter.net](mailto:sboerner@charter.net)

Phone: 636-537-2495

<http://www.astroleague.org/programs/radio-astronomy-observing-program>

#### Radio Jove



The Radio Jove Project monitors the storms of Jupiter, solar activity and the galactic background. The radio telescope can be purchased as a kit, or you can order it assembled. They have a terrific user group you can join. <http://radiojove.gsfc.nasa.gov/>

## INSPIRE Program



The INSPIRE program uses build-it-yourself radio telescope kits to measure and record VLF emissions such as tweeks, whistlers, sferics, and chorus along with man-made emissions. This is a very portable unit that can be easily transported to remote sites for observations.

<http://theinspireproject.org/default.asp?contentID=27>

## SARA/Stanford SuperSID



Stanford Solar Center and the Society of Amateur Radio Astronomers have teamed up to produce and distribute the SuperSID (Sudden Ionospheric Disturbance) monitor. The monitor utilizes a simple pre-amp to magnify the VLF radio signals which are then fed into a high-definition sound card. This design allows the user to monitor and record multiple frequencies simultaneously. The unit uses a compact 1-meter loop antenna that can be used indoors or outside. This is an ideal project for the radio astronomer that has limited space. To request a unit, send an e-mail to [supersid@radio-astronomy.org](mailto:supersid@radio-astronomy.org)

## Radio Astronomy Online Resources

SARA YouTube Videos: <a href="https://www.youtube.com/@radio-astronomy">https://www.youtube.com/@radio-astronomy</a>	Pisgah Astronomical Research Institute: <a href="http://www.pari.edu">www.pari.edu</a>
AJ4CO Observatory – Radio Astronomy Website: <a href="http://www.aj4co.org/">http://www.aj4co.org/</a>	A New Radio Telescope for Mexico - ORION 2021 01 20. Dr. Stan Kurtz <a href="https://www.youtube.com/watch?v=Q9aBWr1aBVc">https://www.youtube.com/watch?v=Q9aBWr1aBVc</a>
Radio Astronomy calculators <a href="https://www.aj4co.org/Calculators/Calculators.html">https://www.aj4co.org/Calculators/Calculators.html</a>	National Radio Astronomy Observatory <a href="http://www.nrao.edu">http://www.nrao.edu</a>
Introduction to Amateur Radio Astronomy (presentation) <a href="http://www.aj4co.org/Publications/Intro%20to%20Amateur%20Radio%20Astronomy,%20Typinski%20(AAC,%202016)%20v2.pdf">http://www.aj4co.org/Publications/Intro%20to%20Amateur%20Radio%20Astronomy,%20Typinski%20(AAC,%202016)%20v2.pdf</a>	NRAO Essential Radio Astronomy Course <a href="http://www.cv.nrao.edu/course/astr534/ERA.shtml">http://www.cv.nrao.edu/course/astr534/ERA.shtml</a>
RF Associates Richard Flagg, rf@hawaii.rr.com 1721-1 Young Street, Honolulu, HI 96826	Exotic Ions and Molecules in Interstellar Space -- ORION 2020 10 21. Dr. Bob Compton <a href="https://www.youtube.com/watch?v=r6cKhp23SUo&amp;t=5s">https://www.youtube.com/watch?v=r6cKhp23SUo&amp;t=5s</a>
RFSpace, Inc. <a href="http://www.rfspace.com">http://www.rfspace.com</a>	The Radio JOVE Project & NASA Citizen Science – ORION 2020.6.17. Dr. Chuck Higgins <a href="https://www.youtube.com/watch?v=s6eWAXjywp8&amp;t=5s">https://www.youtube.com/watch?v=s6eWAXjywp8&amp;t=5s</a>
CALLISTO Receiver & e-CALLISTO <a href="http://www.reeve.com/Solar/e-CALLISTO/e-callisto.htm">http://www.reeve.com/Solar/e-CALLISTO/e-callisto.htm</a>	UK Radio Astronomy Association <a href="http://www.ukraa.com/">http://www.ukraa.com/</a>
Deep Space Exploration Society <a href="http://DSES.science">http://DSES.science</a>	CALLISTO software and data archive: <a href="http://www.e-callisto.org">www.e-callisto.org</a>
Deep Space Object Astrophotography Part 1 -- ORION 2021 02 17. George Sradnov <a href="https://www.youtube.com/watch?v=Pm_Rs17KlyQ">https://www.youtube.com/watch?v=Pm_Rs17KlyQ</a>	Radio Jove Spectrograph Users Group <a href="http://www.radiojove.org/SUG/">http://www.radiojove.org/SUG/</a>
European Radio Astronomy Club <a href="http://www.eraonet.org">http://www.eraonet.org</a>	Radio Sky Publishing <a href="http://radiosky.com">http://radiosky.com</a>
British Astronomical Association – Radio Astronomy Group <a href="http://www.britastro.org/baa/">http://www.britastro.org/baa/</a>	The Arecibo Radio Telescope; It's History, Collapse, and Future - ORION 2020.12.16. Dr. Stan Kurtz, Dr. David Fields <a href="https://www.youtube.com/watch?v=rBZIPOLNX9E">https://www.youtube.com/watch?v=rBZIPOLNX9E</a>
Forum and Discussion Group <a href="http://groups.google.com/group/sara-list">http://groups.google.com/group/sara-list</a>	Shirleys Bay Radio Astronomy Consortium <a href="mailto:marcus@propulsionpolymers.com">marcus@propulsionpolymers.com</a>
GNU Radio <a href="https://www.gnuradio.org/">https://www.gnuradio.org/</a>	SARA Twitter feed <a href="https://twitter.com/RadioAstronomy1">https://twitter.com/RadioAstronomy1</a>
SETI League <a href="http://www.setileague.org">http://www.setileague.org</a>	SARA Web Site <a href="http://radio-astronomy.org">http://radio-astronomy.org</a>
NRAO Essential Radio Astronomy Course <a href="http://www.cv.nrao.edu/course/astr534/ERA.shtml">http://www.cv.nrao.edu/course/astr534/ERA.shtml</a>	Simple Aurora Monitor: Magnetometer <a href="http://www.reeve.com/SAMDescription.htm">http://www.reeve.com/SAMDescription.htm</a>
NASA Radio JOVE Project <a href="http://radiojove.gsfc.nasa.gov">http://radiojove.gsfc.nasa.gov</a> Archive: <a href="http://radiojove.org/archive.html">http://radiojove.org/archive.html</a> <a href="https://groups.io/g/radio-jove">https://groups.io/g/radio-jove</a>	Stanford Solar Center <a href="http://solar-center.stanford.edu/SID/">http://solar-center.stanford.edu/SID/</a>
National Radio Astronomy Observatory <a href="http://www.nrao.edu">http://www.nrao.edu</a>	



## For Sale, Trade and Wanted

At the SARA online store: [radio-astronomy.org/store](http://radio-astronomy.org/store).

### Scope in a Box

[radio-astronomy.org/store](http://radio-astronomy.org/store).

Kit of parts and software to build a working Radio Telescope to detect Hydrogen Line emissions. Available to USA addresses only at this time.

### SuperSID Complete Kit

[radio-astronomy.org/store](http://radio-astronomy.org/store).



### SARA Publication, Journals and Conference Proceedings (various prices)

[radio-astronomy.org/store](http://radio-astronomy.org/store).

### SARA Journal Online Download

[radio-astronomy.org/store](http://radio-astronomy.org/store).

The USB drive covers the society journal "Radio Astronomy" from the founding of the organization in 1981 thru 2020. Articles cover a wide range of topics including: cosmic radiation, pulsars, quasars, meteor detection, solar observing, Jupiter, Radio Jove, gamma ray bursts, the Itty Bitty Telescope (IBT), dark matter, black holes, the Jansky antenna, methanol masers, mapping at 408 MHz and more. This CD contains all of the above and more with over 4800 pages of articles on radio astronomy. Also included is a copy of Grote Reber's handwritten, 34-page document "Carriage and Mirror Detail" of his historic antenna now on display at the National Radio Astronomy Observatory (NRAO) in Greenbank, WV. You also get an electronic copy of the 109 page "Basics of Radio Astronomy" from JPL Goldstone-Apple Valley Radio Telescope. Also included is the NRAO 40-foot radio telescope "Operators Manual", which by the way, you get to operate if you attend the Eastern SARA conference in July.

## SARA Advertisements

There is no charge to place an ad in Radio Astronomy; but you must be a current SARA member. Ads must be pertinent to radio astronomy and are subject to the editor's approval and alteration for brevity. Please send your "For Sale," "Trade," or "Wanted" ads to [edit@radio-astronomy.org](mailto:edit@radio-astronomy.org). Please include email and/or telephone contact information. Please keep your ad text to a reasonable length. Ads run for one bimonthly issue unless you request otherwise.

### **Radio-Astro-Machine, [zblac@gmail.com](mailto:zblac@gmail.com)**

Elevation rotation adapter plate for Scope in a Box and custom machining. For further information visit <https://radio-astro-machine.wixsite.com/my-site> or send an email.

### **Typinski Radio Astronomy, Inc., [info@typinski.com](mailto:info@typinski.com)**

Antenna systems and feed line components for HF radio astronomy

### **Jeff Kruth, WA3ZKR, [kmec@aol.com](mailto:kmec@aol.com)**

RF components from HF to MMW, various types including mixers, RF switches, amplifiers, oscillators, coaxial components, waveguide components, etc. I have a very large collection of stuff and the facilities to test and provide data. Please email with your needs and I will see if I have something for you. Have fun!

### **Stuart and Lorraine Rumley, [sales@valontechnology.com](mailto:sales@valontechnology.com)**

The Valon Technology 2100 Downconverter, when combined with our 5009 frequency synthesizer module, provides a high-performance, compact receiver downconverter system. Applications include hydrogen line studies at 1420MHz and radio astronomy in the protected 30MHz segment of the 21 cm band. For more information visit <http://www.valontechnology.com/2100downconverter.html> or send an email.

### **Radio2Space, [filippo.bradaschia@primalucelab.com](mailto:filippo.bradaschia@primalucelab.com)**

SPIDER radio telescopes and turn-key-systems designed specifically for education.

<https://www.radio2space.com>

We developed our SPIDER radio telescopes as turn-key-system just to avoid the problem you perfectly highlighted in your website: "Purchasing a radio telescope isn't like buying an optical telescope. They are harder to find, and usually require assembly and software troubleshooting. In some cases, a radio telescope must be built from components." Our SPIDER radio telescopes are not designed for amateurs that prefer to build a radio telescope but to schools, universities, museums, and other science institutes that needs for a complete and ready-to-use system, just like the optical telescopes they can normally buy!

### Membership Information

Annual SARA dues Individual \$20, Classroom \$20, Student \$5 (US funds) anywhere in the world. Membership includes a subscription to Radio Astronomy, the bimonthly Journal of The Society of Amateur Radio Astronomers, delivered electronically (via a secure web link, emailed to you as each new issue is posted). We regret that printing and postage costs prevent SARA from providing hardcopy subscriptions to our Journal.

We would appreciate the following information included with your check or money order, made payable to SARA:

Name: \_\_\_\_\_  
 Email Address: \_\_\_\_\_  
(required for electronic Journal delivery)  
 Ham call sign: \_\_\_\_\_ (if applicable)  
 Address: \_\_\_\_\_  
 City: \_\_\_\_\_  
 State: \_\_\_\_\_  
 Zip: \_\_\_\_\_  
 Country: \_\_\_\_\_  
 Phone: \_\_\_\_\_

Please include a note of your interests. Send your application for membership, along with your remittance, to our Treasurer.

For further information, see our website at: <http://radio-astronomy.org/membership>



### How to get started?

SARA has a made a kit of software and parts to detect the Hydrogen line signal from space. This is an excellent method to get started in radio astronomy. It teaches the principles of antenna design, signal detection, and signal processing. Read more about this and other projects on our web site.

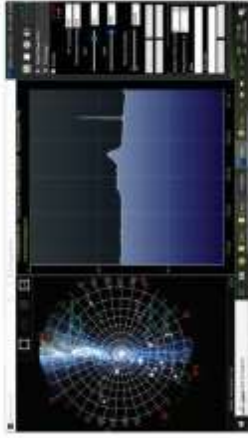

Membership supported, nonprofit [501(c) (3)] Educational and Radio Astronomy Organization  
**Knowledge through Common Research, Education and Mentoring**



SARA members have been privileged to use this forty foot diameter drift-scan hydrogen line radio telescope every year at their annual meeting in Green Bank.

<http://radio-astronomy.org>

**Why Radio Astronomy?**  
 Because about sixty five percent of our current knowledge of the universe has stemmed from radio astronomy alone. The discovery of quasars, pulsars, black holes, the 3K background from the "Big Bang" and the discovery of biochemical hydrogen/carbon molecules are all the result of professional radio astronomy.



## The Society of Amateur Radio Astronomers

SARA was founded in 1981, with the purpose of educating those interested in pursuing amateur radio astronomy.

The society is open to all, wishing to participate with others, worldwide.

SARA members have many interests, some are as follows:

### SARA Areas of Study and Research:

- Solar Radio Astronomy
- Galactic Radio Astronomy
- Meteor Detection
- Jupiter
- SETI
- Gamma Ray/High Energy Pulse Detection
- Antennas
- Design of Hardware / Software

The members of the society offer a friendly mentor atmosphere. All questions and inquiries are answered in a constructive manner. No question is silly!

SARA offers its members an electronic bi-monthly journal entitled Radio Astronomy. Within the journal, members report on their research and observations. In addition, members receive updates on the professional radio astronomy community and, society news.

Once a year SARA meets for a three-day conference at the Green Bank Observatory in Green Bank West Va.

There is also a spring conference held at various cities in the Western USA. Previous meetings have been at the VLA in Socorro, NM and at Stanford University.



### How do amateurs do radio astronomy?

Radio astronomy by amateurs is conducted using antennas of various shapes and sizes, from smaller parabolic dishes to simple wire antennas. These antennas are connected to receivers and most of these receivers are software defined radios these days. Data from the receivers are collected by computers, and the received signals will be displayed as charts, graphs or maybe even sky maps. As diverse as the observed objects, so is the instruments and tools used. SARA members will always be supportive to find good solutions for what one wishes to observe.

### Is amateur radio astronomy instrumentation expensive?

Technical information freely circulated in our monthly journal helps amateurs to obtain good low noise equipment from off the shelf assemblies, or to build their own units. The actual cash investment in radio astronomy equipment need not exceed that of any other hobby.

### What are amateurs actually looking for in the received data?

The aim of the radio amateur is to find something new and unusual. Just as an amateur optical observer hopes to notice a supernova or a new comet, so does an amateur radio observer hope to notice a new radio source, or one whose radiation has changed appreciably.

### How do I get started?

Just as a long journey begins with the first step, the project you elect must start with a clear idea of your objectives. Do you wish to study the sun? Jupiter? Make meteor counts? Do you wish to engage in imaging radio astronomy? What you decide will not only determine the type of equipment you will need, but also the local radio spectrum.



The Reber Telescope at NRAO. Constructed by Grote Reber in 1937 in his backyard in Wheaton, Illinois



SARA Members discussing the IBT (Itty Bitty Telescope)

