

# RADIO ASTRONOMY

Journal of the Society of Amateur Radio Astronomers  
May – June 2022

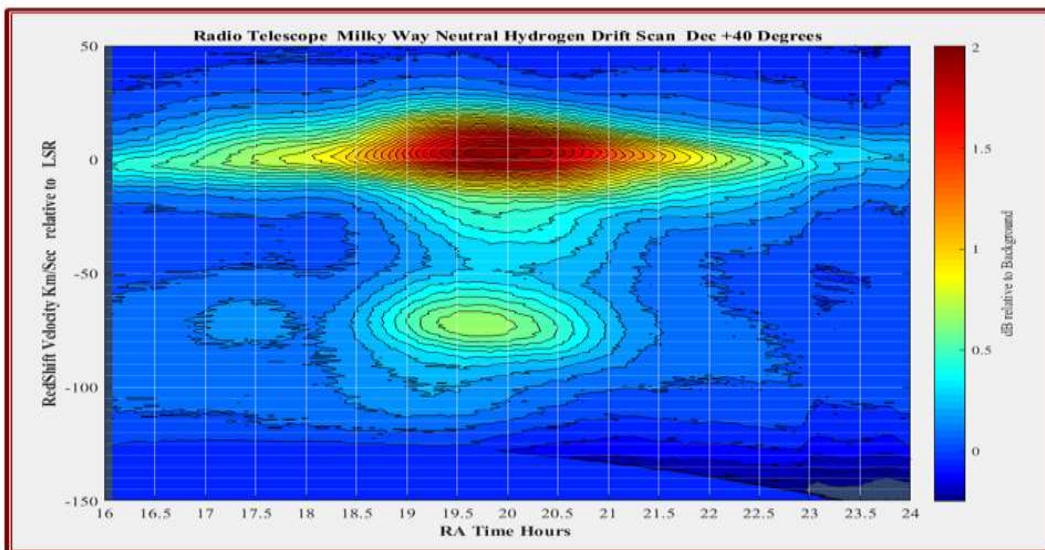

Enhanced "Scope in a Box"

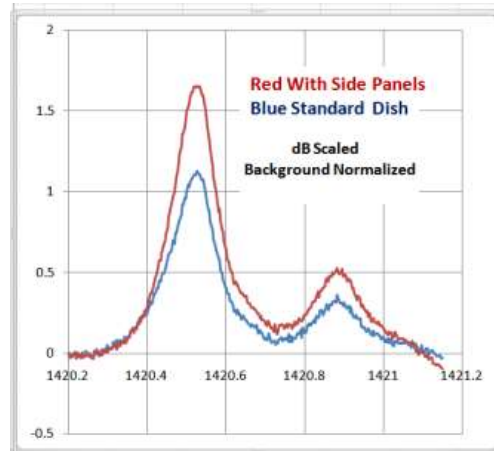

**Dennis Farr**  
*SARA President*

**Dr. Richard A. Russel**  
*Editor*

**Whitham D. Reeve**  
*Contributing Editor*

Radio Astronomy is published bimonthly as the official journal of the Society of Amateur Radio Astronomers. Duplication of uncopyrighted material for educational purposes is permitted but credit shall be given to SARA and to the specific author. Copyrighted materials may not be copied without written permission from the copyright owner.

Radio Astronomy is available for download only by SARA members from the SARA web site and may not be posted anywhere else.

It is the mission of the Society of Amateur Radio Astronomers (SARA) to: Facilitate the flow of information pertinent to the field of Radio Astronomy among our members; Promote members to mentor newcomers to our hobby and share the excitement of radio astronomy with other interested persons and organizations; Promote individual and multi station observing programs; Encourage programs that enhance the technical abilities of our members to monitor cosmic radio signals, as well as to share and analyze such signals; Encourage educational programs within SARA and educational outreach initiatives. Founded in 1981, the Society of Amateur Radio Astronomers, Inc. is a membership supported, non-profit [501(c) (3)], educational and scientific corporation. Copyright © 2022 by the Society of Amateur Radio Astronomers, Inc. All rights reserved.

Cover Photo: B Alex Pettit Jr  
KK4VB

## Contents

<b>Radio Waves</b> .....	2
President's Page .....	2
Editor's Notes .....	3
<b>SARA NOTES</b> .....	4
<b>VINTAGE SARA</b> .....	13
<b>News: (May-June 2022)</b> .....	17
<b>Technical Knowledge &amp; Education: (May-June 2022)</b> .....	19
<b>Announcements: May-June 2022</b> .....	20
SuperSID .....	25
Announcing Radio JOVE 2.0.....	28
John Cook's VLF Report .....	34
BAA RA Section Autumn programme 2022 .....	57
<b>Feature Articles</b> .....	59
Development of a Telescope Tracking System - Part 3 .....	59
Power Coupler for VLF and LF Antenna Applications .....	67
Refurbishing an SRT Part 2: RF chain, rotor and motion control system .....	74
Python Plotting of Compressed GNU Radio Pulsar Data .....	85
Overcoming Design Deficiencies in <i>RigRunner</i> DC Distribution Panels .....	92
<b>Observation Reports</b> .....	95
Detection of Pulsar B0329+54 with J.R.T. [Job's Radio Telescope - 1.9 meter] .....	95
Spectral Analysis of an H1 Hydrogen Emission Region within the Milky Way Using an Enhanced " SARA Scope_in_a_Box " Radio Telescope .....	103
Solar Radio Observations at Anchorage, Cohoe and HAARP Radio Observatories .....	107
Portable Antenna Mast Hold Down Notes: .....	113
Dual Radio Jove FRB Detection System Tests .....	114
<b>Membership</b> .....	116
New Members .....	116
Journal Archives & Other Promotions .....	116
SARA Online Discussion Group .....	117
What is Radio Astronomy? .....	117
<b>Administrative</b> .....	118
Officers, directors, and additional SARA contacts .....	118
<b>Resources</b> .....	119
Great Projects to Get Started in Radio Astronomy .....	119
Radio Astronomy Online Resources .....	121
<b>For Sale, Trade and Wanted</b> .....	122
<b>SARA Advertisements</b> .....	124
SARA Brochure.....	125

## Radio Waves

### President's Page



It has been an honor to serve as your president! We have accomplished a lot in the past couple of years.

- The “Scope in the Box” project has brought hydrogen astronomy to many.
  - Drake’s Lounge has significantly increased the communications between members.
  - The use of ZOOM has allowed us to hold multiple Eastern and Western Conferences virtually throughout the pandemic.
  - The Treasurer position was smoothly transitioned to Brian O’Rourke, who has done a magnificent job!
- We now have a store manager, Lester Veenstra, who has been instrumental in coordinating the purchasing and distribution of the Scope in the Box for SARA.
  - Thanks to Rich Russel for coordinating the Drake’s Lounge and now the new Radio Telescope Observation Party (RTOP) virtual sessions.

Sincerely,

Dennis Farr  
President

## Editor's Notes

We are always looking for basic radio astronomy articles, radio astronomy tutorials, theoretical articles, application and construction articles, news pertinent to radio astronomy, profiles and interviews with amateur and professional radio astronomers, book reviews, puzzles (including word challenges, riddles, and crossword puzzles), anecdotes, expository on "bad astronomy," articles on radio astronomy observations, suggestions for reprint of articles from past journals, book reviews and other publications, and announcements of radio astronomy star parties, meetings, and outreach activities.

## Subscribe to the SARA YouTube Channel

SARA has a YouTube channel at: <https://www.youtube.com/channel/UC-SzptAQZ-20c9CkRb9ZPxxw>

We are also looking to add content to the site. Anyone who wants to help produce a series of 5 - minute videos relating to radio astronomy technology or observations please contact me. ([drrichrussel@netscape.net](mailto:drrichrussel@netscape.net))

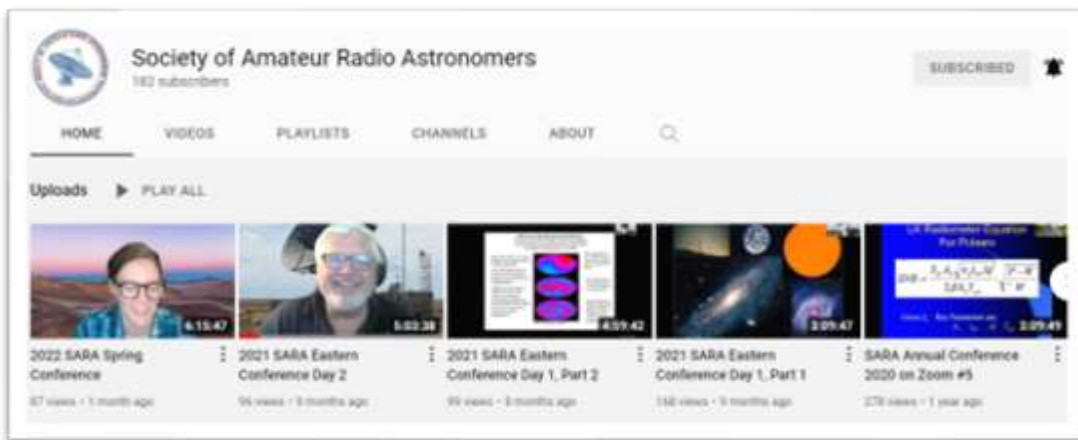

## Observation Reports

We are now accepting 1-2 page observation reports. These reports should include the astronomical objects RA/DEC plus UTC of the observation. Also include the telescope configuration, process used to observe the object and results. Picture of the setup and plots of the observation are a plus to the report.

If you would like to write an article for Radio Astronomy, please follow **the newly updated Author's Guide** on the SARA web site:

[http://www.radio-astronomy.org/publicat/RA-JSARA\\_Author's\\_Guide.pdf](http://www.radio-astronomy.org/publicat/RA-JSARA_Author's_Guide.pdf).

Let us know if you have questions; we are glad to assist authors with their articles and papers and will not hesitate to work with you. You may contact your editors any time via email here: [edit@radio-astronomy.org](mailto:edit@radio-astronomy.org).

The editor(s) will acknowledge that they have received your submission within two days. If they do not reply, assume they did not receive it and please try again.

Please consider submitting your radio astronomy observations for publication: any object, any wavelength. Strip charts, spectrograms, magnetograms, meteor scatter records, space radar records, photographs; examples of radio frequency interference (RFI) are also welcome.

Guidelines for submitting observations may be found here: [http://www.radio-astronomy.org/publicat/RA-JSARA\\_Observation\\_Submission\\_Guide.pdf](http://www.radio-astronomy.org/publicat/RA-JSARA_Observation_Submission_Guide.pdf)

**SARA NOTES**

**SARA Election Ballot July 2022**

Bruce Randall, Secretary

Because of the Eastern Conference being a web-based event, this year Elections will be done differently.

Email ballots are requested before the conference and will be handled the same as 2021.

**SARA 2022 Voting Ballot**

**President: Vote for One (1)**

\_\_\_\_ Dr. Richard Russel

\_\_\_\_ Write-In \_\_\_\_\_

**Vice President: Vote for One (1)**

\_\_\_\_ Write-In \_\_\_\_\_

**Director: Vote for Two (2)**

\_\_\_\_ Ed Harfmann

\_\_\_\_ Stephen Tzikas

\_\_\_\_ Jay Wilson

\_\_\_\_ Write-In \_\_\_\_\_

\_\_\_\_ Write-In \_\_\_\_\_

**Director at Large: Vote for Two (2)**

\_\_\_\_ David Westman

\_\_\_\_ Keith Payea

\_\_\_\_ Bob Stricklin

\_\_\_\_ Write-In \_\_\_\_\_

\_\_\_\_ Write-In \_\_\_\_\_

Members voting by e-mail should send their completed ballot to

SARA Secretary [brandall@comporium.net](mailto:brandall@comporium.net)

no later than July 30, 2022, 9:00 PM EDT. **Copying and pasting the ballot into the email will work. Then you can then mark your choices in the email.**

## **2022 SARA Eastern Conference is Virtual Only Again (Hopefully for the last time!)**

We are sorry that we will not be able to see each other at Green Bank this year but we are planning to restart the physical conferences next year at the VLA for the Western Conference and Green Bank for the Eastern Conference. The 2022 SARA Eastern virtual conference will be held on Saturday and Sunday to allow for people's work. The new dates are **July 30– 31, 2022**. The schedule will include sessions all day Saturday and half of the day Sunday afternoon to accommodate peoples worship services in the morning.

Conference cost will be **\$15** to cover expenses.

Register at: <https://www.radio-astronomy.org/node/318>

### **Door Prizes for Eastern Conference Registrants**

If you are registered and signed into the Eastern Conference, you are eligible to win one of the following door prizes:

- 2 SuperSID Radio Telescopes
- 2 Scope in a Box Radio Telescopes
- 2 Itty Bitty Radio telescopes
- 2 Radio Jove 2 Telescopes
- 2 2022 SARA Memberships
- 4 SARA Shirts (S, M, L)
- 3 Radio Sky Software Licenses:

## SARA 2022 Eastern Conference Keynote Speaker

Dr. Wolfgang Herrmann

**About the Keynote Speaker:** Dr. Wolfgang Herrmann received his PhD from the university of Bonn. The subject matter of the thesis was laser spectroscopy, which was also the subject of his subsequent work at the IBM research labs in Zurich and the GKSS research center in Hamburg. He moved on to work in the telecommunication industry where he served as member of the board of a company making advanced communication systems. Finally, he founded his own consulting company. He was supporting and advising major telecommunication carriers in the implementation of specialized radio and fixed line communication networks for the railway and aviation industry as well as high security networks for public administrations.

Being retired now, he enjoys serving as president of the Astropfeiler Stockert group which operates one of the largest radio telescopes in the hand of amateurs. In the little time left over from astronomy, he enjoys leaving solid ground by going sailing and flying small aircraft.



## **SARA 2022 Eastern Conference Abstracts**

### **Keynote**

#### **Amateur Radio Astronomy Possibilities and Limitations Do's and Don'ts**

**Wolfgang Herrmann, Astropeiler Stockert e.V.**

Amateur radio astronomy covers a wide field from meteors, our solar system, objects in the milky way and extragalactic sources. Very different physical processes cause the emission which can be observed. Due to great variety of observing objects, different approaches are required for each of these areas.

The talk will give an overview of the options which are open to amateurs and discuss the required instrumentation and tools to be successful. Examples will be given from various amateur observatories what can be achieved. Naturally, there are also various pitfalls which can get in the way. The talk will discuss, what mistakes should be avoided and what path might be good to become a "professional amateur".

### **Polarized pulse pairs in the search for extraterrestrial intelligence**

**William J. (Skip) Crilly Jr**

A system of radio telescopes has been operated since 2017 to search for hypothetical interstellar microwave communication signals. The candidate signal includes two narrow bandwidth pulses having differing polarization and near-zero interarrival time and frequency. Knowledge of random noise statistics permits the calculation of the likelihood of false positives during a scan of Right Ascension. Robust RFI excision has been implemented. The search has resulted in anomalous measurements that include geographically-spaced simultaneous pulse observations, and apparent anomalous symbol repetition and quantization, observed in a celestial direction near the star Rigel. This presentation summarizes the hypothetical communication system, describes salient experimental results, and proposes conclusions and further work.

### **Web Application for LoFASM Data Mining**

**Tom Hagen**

The Low Frequency All Sky Monitor (LoFASM) project monitors celestial and other radio emissions in the 5-88 MHz range. A LoFASM station consists of an array of twelve crossed dipole antennas originally developed for the Long Wavelength Array system at the VLA observatory in Socorro, New Mexico. There are currently four operational LoFASM stations scattered across the United States.

The LoFASM system was created in 2015 by the University of Texas-Rio Grande Valley (UTRGV). Louis Dartez, at the time a graduate student at UTRGV, developed the system to operate the array and archive the data. Dr. Dartez has been helping me create a web-based application to enable human inspection of the hundreds of plots created each day by just one station. The goal is to identify transient signals and other anomalies. It is hoped that after enough plots have been inspected, patterns will emerge so that an artificial intelligence system can be created to perform the same task.

The web app is based on the open-source Dash Plotly data analytical software. This gives the developer Python tools and libraries to analyze the raw LoFASM data. An interactive web graphical display is created for the user to mark and record anomalies. In addition, the setup runs on a virtual Docker container. The Docker system allows



me to develop the interface on a Raspberry Pi 4 with the intent of eventually moving the intact container over to an online web service so that many people can use it to go through the data and record their observations.

## **Introduction to Radio Astronomy** **Ed Harfmann**

Join us for an introduction and review of radio astronomy. We will cover:

- Why radio astronomy is important to our understanding of the universe.
- A brief review of how it got started to when it became seriously recognized as a serious science.
- What do the professionals use and why it is important to amateurs.
- An overview of what people do to get started.
- “Speed bumps” that you can expect and should not detract from your getting started.

This introduction is not meant to explain everything but rather to allow you to see and understand enough to get started in your own adventure as an amateur radio astronomer.

## **The Radio JOVE Project 2.0** **Dr. Chuck Higgins, et.al.**

C. Higgins (1), S. Fung (2), L. Garcia (3), J. Thieman (4), J. Sky (5), D. Typinski (6), R. Flagg (7), J. Brown (8), F. Reyes (9), J. Gass (10), L. Dodd (11), T. Ashcraft (12), W. Greenman (13), J. Cox (14), and S. Blair (15)

- (1) Middle Tennessee State University, Murfreesboro, TN 37132
- (2) ITMPL/NASA GSFC, Greenbelt MD 20771
- (3) SGT/NASA GSFC, Greenbelt MD 20771
- (4) UMBC/NASA GSFC, Greenbelt MD 20771
- (5) Radio Sky Publishing, Louisville, KY, 40214
- (6) AJ4CO Observatory, High Spring, FL 32655
- (7) RF Associates, Honolulu, HI 96826,
- (8) Hawks Nest Radio Astronomy Observatory, Industry, PA 15052
- (9) Dept. of Physics & Astronomy, University of Florida, Gainesville, FL 32611
- (10) CNSP/NASA GSFC, Greenbelt, MD 20771
- (11) Georgia Amateur Radio Astronomy Observatory, Jasper, GA 30143
- (12) Heliotown Observatory, Lamy, NM 87540,
- (13) LGM Radio Alachua, Alachua, FL 32615
- (14) Easley, SC 29640
- (15) Dalton State College, Dalton, GA 30720

Radio JOVE is a well-known public outreach, education, and citizen science project using radio astronomy and a hands-on radio telescope for science inquiry and education. Radio JOVE 2.0 is a new direction using radio spectrographs to provide a path for radio enthusiasts to grow into citizen scientists capable of operating their own radio observatory and providing science-quality data to an archive. Radio JOVE 2.0 uses more capable software defined radios (SDRs) and spectrograph recording software as a low-cost (\$350) radio spectrograph that can address more science questions related to heliophysics, planetary and space weather science, and radio wave propagation. Our goals are: (1) Increase participant access and expand an existing radio spectrograph network, (2) Test and develop radio spectrograph hardware and software, (3) Upgrade the science capability of the data archive, and (4) Develop training modules to help people become citizen scientists. We will overview Radio JOVE 2.0 and give a short demonstration of the new radio spectrograph using the SDRplay RSP1A receiver with a dipole antenna and the associated Radio-Sky Spectrograph (RSS) software.

## **Identify proxies for the Schwabe cycle using Wilcox Solar Observatory data as a reference**

### **Rodney Howe**

Although the WSO data goes back to 1976 there is evidence that the polar solar field magnitudes and duration of each solar cycle cross-over would indicate the Schwabe cycle duration between solar cycles.

<https://agupubs.onlinelibrary.wiley.com/doi/full/10.1002/2012JA018320> This paper has two parts, the first is to show that north and south hemisphere visual observations do NOT represent the WSO polar field cross-overs. The second part uses the Poisson dispersion distribution of the total visual observations (Wolf numbers for the whole disk) to show a useful proxy for past Schwabe cycles.

## **Evaluating the Fast Folding Algorithm for Pulsar Detection**

### **Dan Layne**

The Fast Folding Algorithm (FFA) is a phase-coherent search method to detect periodic signals from pulsars. It has not often been used primarily because Fast Fourier Transform (FFT) methods, such as PRESTO, have been less computationally expensive. However, a recent FFA implementation called RIPTIDE makes efficient use of modern CPU cache architectures so that FFT methods no longer have a speed advantage. In theory, the FFA method is more sensitive than FFT methods, including for longer period pulsars and lower Signal-to-Noise Ratio (SNR). The frequency domain method PRESTO was not designed to be optimal at low SNR where amateurs tend to operate. In contrast, RIPTIDE directly folds data in the time domain and can produce good results at low SNR when PRESTO becomes ambiguous. This empirical study compares PRESTO with RIPTIDE for detecting known pulsars, especially at low SNR. The results show that PRESTO and RIPTIDE both give reliable results when SNR > 10. When SNR is between 4 and 10, both methods can produce acceptable results. When SNR is below 4, PRESTO becomes inconclusive while RIPTIDE can still produce acceptable results down to SNR of 2.7. RIPTIDE appears to be another tool that amateurs may use for detecting and confirming pulsars.

## **Real Time Position Control and Tracking System For Altitude/Azimuth Mounts**

### **Jack H. Lobingier**

This presentation reviews the development of a closed-loop antenna positioning control and tracking system for any Altitude/Azimuth mount. It is designed for remote network operation and in addition allows for the control of other auxiliary functions, such as ENR Calibration signal insertion and 50 Ohm Load switching, Feed Head Focus Positioning, and Altitude/Azimuth beam position setting for the RadioSky.com "Radio Eyes" application. As implemented, it employs off-the-shelf electronics units and small Single Board Computer modules (SBCs). It is adaptable to any single Altitude/Azimuth mount with the proper selection of motors and positioners. The control software is written in Python3 and PyQt5, and although it is currently implemented in Linux, it should be executable in Windows with minor changes. Two previous articles have been published in the SARA Journals of September-October 2021 and March-April 2022, and a third is being submitted for inclusion into a future Journal. These three articles are used as background for this presentation.

**Kudos to the Noise!**  
**TotalPower : a program for RF measures by using the low cost RTL-SDR dongle**  
**Mario Natali**

TotalPower is a multipurpose program that elaborates the RF signal captured via the low cost RTL-SDR dongle.

The main function is the representation of the RF signal both on a graph and on an analog meter. This function is very helpful in antenna pointing.

Another interesting function is the so called "Band explorer" mode that provides tools to analyze very low-level RF Noise. A dedicated configuration of this mode allows easy capture of H-Line.

The program, working in conjunction with the tracking program, PstRotator, can move directly antennas and generate automatically noise maps of an arbitrary sky area. The RF noise data collected are passed to a very powerful 3D engine that allows several analyses including a contour plot.

All the functions will be illustrated, and a live recording will be shown

**Comparing What We See With the "Scope-In-A-Box" and a 3.7 meter Antenna**  
**Charles S. Osborne, K4CSO**

In this presentation we will take a look at the SARA "Scope-In-A-Box" and a 3.7 Meter antenna using the same LNA and RTL-SDR to show how the two differ. Some noise figure test data on the Nooelec SAW Bird H1 LNAs and RTL-SDR will be discussed with a systems engineering view of how coax loss and component placement can affect system performance.

**The \$300 SARA 'Scope in a Box' Radio Telescope System and Beyond**  
*>A beginner's introduction into receiving and processing 1.42 GHz RF emission signals from neutral hydrogen regions within the Milky Way <*  
**Alex Petit**

This presentation will briefly overview the history and value of radio astronomy. It will describe the Analog RF and Digital Signal hardware components and the basic software needed to acquire, process, and display the data. Drift Scan data recording will be explained, and several upgrades will be suggested for improvements in signal amplitude and quality.

**Improving IBT and IF Processor Performance**  
**Bruce Randall NT4RT**

The Itty Bitty Telescope (IBT) is a popular demonstration radio telescope. The IBT is not a serious astronomical instrument, but it does an excellent job of demonstrating what a radio telescope does. The weak link in this instrument is the "Satellite Finder" used for the IF and detector function. This paper describes improvements to the IBT processor described in my June 2018 paper.

Included is an improved Analog to Digital Converter and software improvements for the IBT processor. Block diagrams, schematics, and Arduino source code will be made available.

Antenna aiming improvements using finders from optical telescopes are presented.

A possible calibration scheme is also discussed with the goal of getting repeatable sun and moon temperature measurements.

### **20M Telescope Demo: Raster Scans and Considerations** **Steve Tzikas**

- 20m Project Updates
- 20m Dish Demo
- 20m Useful Comments
- Raster Scans and Considerations
- 20m Observing Podcasts
- Contact and Open Forum

### **SARA Sections Update** **Steve Tzikas**

- A browse through the SARA sections
- Purpose of SARA Sections
- Organization of SARA Sections
- Volunteering
- Section Coordinators
- What's New?
- Suggested Ideas

### **Mitigating SAM-III Magnetometer Sensor Crosstalk** **Whitham D. Reeve**

The SAM-III, or *Simple Aurora Monitor – 3-Axis*, is an upgrade of the original 1- or 2-axis SAM and has been available since 2009. The SAM-III is used for geomagnetic observations and studies and as a geomagnetic disturbance monitor for aurora photography and amateur radio VHF communications.

When the signal outputs from two or three sensors are carried in the same cable to the SAM-III Controller, crosstalk interference can occur depending on the length and type of cable. The sensor outputs are unbalanced, and their signals easily couple into adjacent conductors and become part of the signals from other sensors.

The input circuits in the SAM-III Controller cannot distinguish between the interfering and actual signals. As a result, crosstalk manifests as noisy and inaccurate data and magnetogram traces. Unbalanced sensor signaling circuits also are susceptible to noise from other sources such as powerlines and radio transmission systems.

A robust crosstalk mitigation method is described in this paper including design, construction, and field installation. It uses interface circuitry at both ends of the sensor cable that converts the unbalanced sensor outputs to balanced circuits for transmission over inexpensive *twisted pair* cable. This method is based on the TIA-422 interface, which not only ensures sensor signal integrity but also allows the sensors to be installed much farther from the SAM-III Controller than possible with unbalanced circuits.

**Receivers for a 2000 x 5m Radio Camera in Nevada**  
**Dr. Sander Weinreb, L. D'Addario, J. Flygare, K. Shila, and J. Shi**

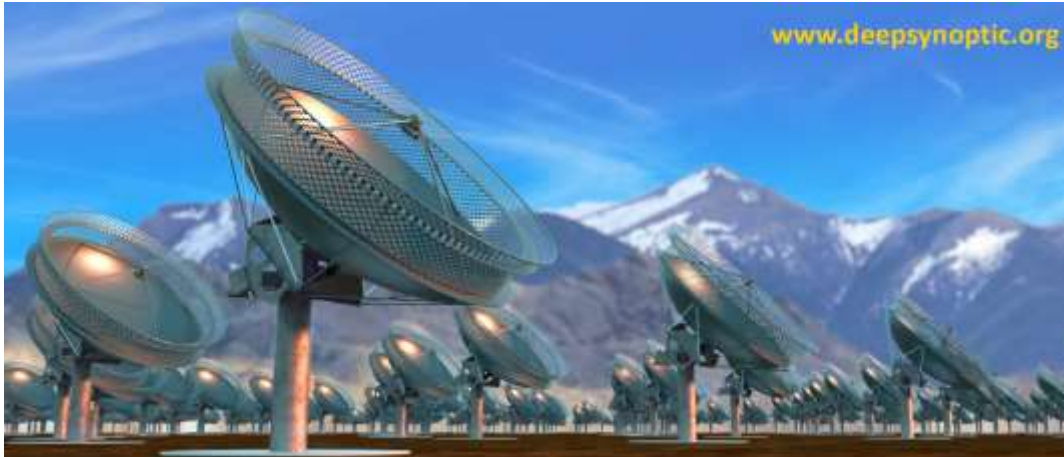

A radio telescope array with extraordinary sensitivity, resolution, and survey-speed is presently under design by the radio astronomy group at Caltech. The array consists of 2000 fully-steerable paraboloidal 5m-diameter reflectors operating in the 700 MHz to 2000 MHz range, to be distributed in a 19 km x 15 km area in central Nevada. The array is a radio-camera in the sense that it will provide images of most of the sky with 3.3 arcsecond resolution, and sensitivity of 0.5 micro-Janskies. It is expected that these images will observe 109 galaxies, 104 fast radio bursts, and  $10^4$  pulsars. The cost goal is \$100M with a combination of public and private funds and completion by 2027.

The basic principle of the array is to measure the 4 million correlation cross products of the 2000 antennas to form a two-dimensional correlation function vs vector position on the earth surface. The 2-D Fourier transform of this correlation function is then the brightness image of the sky.

The major components of the array are:

- 1) 2000 hydroformed reflectors with system noise temperature of 25K
- 2) Wideband, dual polarized feeds on each antenna
- 3) 4000 uncooled LNAs with 11K noise averaged of the frequency range
- 4) Fiber optic, analog RF over fiber transmission of the signals from each antenna to a central correlator and image processing system.
- 5) Digital filter bank processing of the 1300 MHz band into 0.1 MHz channels
- 6) Cross-correlation of the 2000 antennas signals
- 7) Fourier transformation of the correlation function to form the radio camera image.

The presentation will cover further details of the feeds, LNAs, and fiber optic transmission system.

# VINTAGE SARA

If you were active in SARA's early years, 1981 – 2000, please dig into your photo archives and share some of the memories.

Most of our digital images start around 1999, but we desperately need more from the early years. If you have scanned or can scan hardcopy images or negatives we would love to share them with our new members via the SARA archives. Remember you can't create detail that isn't there, so higher resolution up to around 5MB is OK. We can always reduce resolution to create thumbnails or as needed for a given situation. On group shots even bigger is better.

Dennis has asked me to act as Historian and help dig up and orchestrate this aspect of our SARA history. Let me know what you have or show me some samples. If you have a DropBox account we can more easily share higher resolution image collections that way. If you don't have a way to scan we'll work something out.

The newest response to our request is a video from SARA member Gene Greneker K4MOG. Gene had Hi8 digital video from 1988 and 1989 showing the 300 foot Green bank Transit Telescope before and after its November 15, 1988 collapse from a stress fracture in a gusset plate.



Also notable in Gene's video is Dan Werthimer speaking to the SARA Conference attendees about his parasitic SETI efforts using the IF of the 300 footer. Dan is today Chief Scientist at Berkeley SETI [<https://seti.berkeley.edu/people/Dan.html>] and is involved in SETI@Home, Breakthrough Listen, and other efforts over the years.

The 1.5 GB video from 35 years ago will be posted once we figure out how to best do it, either on the new SARA YouTube channel [ <https://www.youtube.com/channel/UC-SzptAQZ-20c9CkRb9ZPw> ] or the SARA DropBox.

I also have digital image collections from up on the GBT, VLBA, Arecibo, Kitt Peak, and other places where digital cameras are no longer allowed that I'll be trying to share. I have not been to the VLA or Owens Valley. We even have some other video collections we are trying to share. I have video of Grote Reber visiting with the SARA members in the Drake Lounge telling stories and answering questions. Also have

him giving a lecture called "The Big Bang is Bunk". So, anything similar would also be good ones to share with the rest of the membership if you have some special tour shots.

Send me an email at k4cso at twc dot com. Janis and I have pretty deep photography backgrounds. I'll give you my phone number if you have questions I can't as easily answer via email. If you don't hear back in a reasonable length of time, try me again with a short simple message to make sure it didn't autosort into a spam folder or oblivion.



Forever a part of our history, Bill and Melinda Lord. Bill recently passed away. The pictures are from the 2013 group picture and classroom lectures during time when Bill was SARA President. Bill and Melinda did a lot to grow the organization and increase SARA's exposure at things like the Dayton Hamvention and other public venues. Melinda was Treasurer at the time as well. They were a heck of a team. Our thoughts and prayers go out to Melinda.

**CHARLES OSBORNE,  
SARA HISTORIAN**

**Obituary: WILLIAM KEITH LORD**  
SARA Past President

Washington

William Keith Lord, 69, of Washington, Iowa, died Thursday, April 14, 2022, following a lengthy illness.

Celebration of life services will be held 1:30 p.m. Tuesday, April 19, 2022, at the Jones & Eden Funeral Home with Pastor Darren Brown officiating. Military honors will be accorded by Washington American Legion Post 29. Calling hours will begin 3 p.m. Monday at the Jones & Eden Funeral Home where the family will be present to receive friends from 5 to 7 Monday evening. Interment will take place at a later date. Memorials have been established for Hospice of Washington County, Bows and Bullets 4H Group, or Trials and Tribulations Ministry. Online condolences may sent for Bill's family through the web at [www.jonesfh.com](http://www.jonesfh.com).

William Keith Lord was born March 26, 1953, in Los Angeles, California, the son of Ronald Keith and Mary Irene (Edgar) Lord. Bill attended school in Washington, Iowa, graduating from Washington High School in 1971. Bill served honorably in the United States Navy from 1971 until 1974. He was united in marriage to Melinda Reed on February 14, 1975, in Washington, Iowa.

Bill and Melinda lived in Washington, Iowa, Ft. Lauderdale, Florida, and Cleveland, Tennessee, before returning to Washington in 2010. Bill worked as a shift manager for a chemical plant for many years and was a National Safety Officer for the Civil Air Patrol. Bill was proud to have received his pilot's license and enjoyed flying. Bill and Melinda enjoyed scuba diving, hiking, river rafting, and cave exploring. Bill and Melinda were both involved in Optical and Radio Astronomy where Bill served as the International President of the Society of Amateur Radio Astronomy. He was a supporter of all types of gun sports.

He is survived by his wife, Melinda Lord of Washington, Iowa; sister, Bessie Ann Lord of Stark City, Missouri; his in-law, Roger Reed, David Reed, Bernice Darby, and Nick (Sue) Reed all of Washington, Iowa; as well as many nieces and nephews.

Bill was preceded in death by his parents.



## SARA Student & Teacher Grant Program

All, SARA has a grant program that is, sad to say very underutilized. We will provide kits or money to students and teachers including college students to help them with a radio telescope project. SARA can supply any of the following kits:

- [1] SuperSID
- [2] Scope in a Box
- [3] IBT (Itty Bitty Telescope)
- [4] Radio Jove kit
- [5] Inspire
- [6] Sky Scan

We can also provide up to five hundred dollars (\$500.00 USD) for an approved radio telescope project.

We have on occasion provided more money based on the merits of the project and the SARA Grant Committee approval.

More information on the grant program can be found at the URL below.

[SARA Student and Teacher Project Grants | Society of Amateur Radio Astronomers \(radio-astronomy.org\)](https://www.radio-astronomy.org/SARA-Student-and-Teacher-Project-Grants)

All that is required is the SARA grant request form be filled out and sent in. If it needs more work for approval, we will work with the student to help ensure their success.

Please pass the word that SARA will fund any legitimate radio telescope project anywhere in the world.

If you have a question, contact me at [crowleytj at hotmail](mailto:crowleytj@hotmail.com) dot com.

Tom Crowley  
SARA Grant Program Administrator

## **NEW** Radio Telescope Observation Party (RTOP)

RTOP is designed to demonstrate how to take observations using various radio telescopes. It will also cover how to record and analyze data.

RTOP is every month on the 1<sup>st</sup> Sunday at 2 pm Eastern time. ZOOM email notifications will be sent to all members.

## **Drake's Lounge**

Join the SARA community as we discuss the latest astronomy and radio astronomy news. The lounge also provides a forum to share and get advice on your radio astronomy projects from very experienced amateur radio astronomers.

Drake's Lounge is every month on the 3<sup>rd</sup> Sunday at 2 pm Eastern time. ZOOM email notifications will be sent to all members.

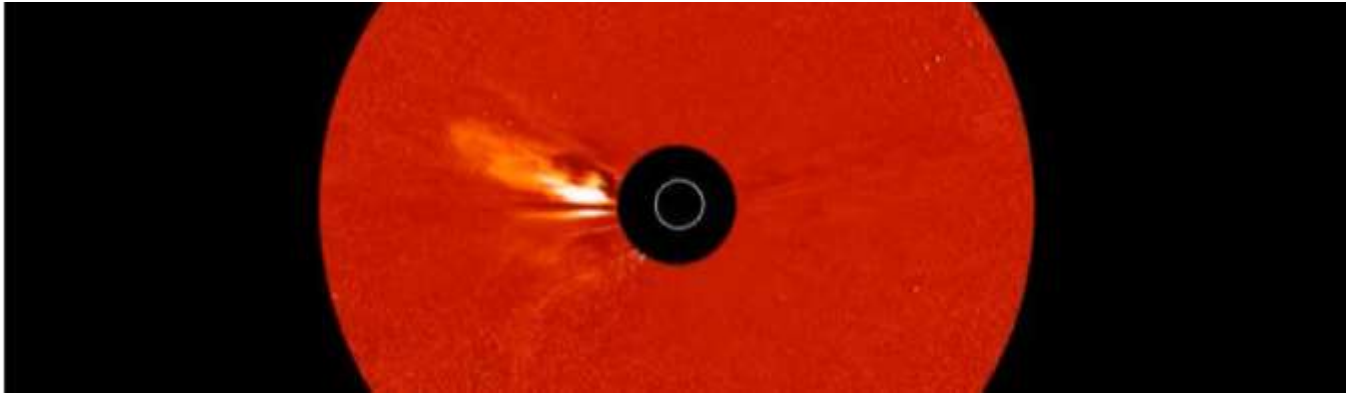

Solar Terrestrial Centre of Excellence, STCE ~ *The finest solar and space weather events of 2021!*

[https://www.youtube.com/watch?v=K\\_4E9NXDYj0](https://www.youtube.com/watch?v=K_4E9NXDYj0)

More info on the individual events at <https://www.stce.be/highlights>

Physics Today ~ *Depolarized waves point to the origin of fast radio bursts:*

<https://physicstoday.scitation.org/doi/10.1063/PT.6.1.20220317a/full/>

SETI Institute ~ *COSMIC: All Antennas at the Very Large Array Ready to Stream Data for Technosignature Research:*

<https://www.seti.org/press-release/cosmic-all-antennas-very-large-array-ready-stream-data-technosignature-research>

EDN ~ *Getting real with the real-time clock:* <https://www.edn.com/getting-real-with-the-real-time-clock/>

University Today ~ *Traveling the Solar System with Pulsar Navigation:*

<https://www.universetoday.com/155791/traveling-the-solar-system-with-pulsar-navigation/>

NASA JPL Youtube video ~ *The Lunar Crater Radio Telescope with Dr. Ashish Goel:*

<https://www.youtube.com/watch?v=gAbhi4EMyO8>

Springer Link ~ *Fast radio bursts at the dawn of the 2020s:*

<https://link.springer.com/article/10.1007/s00159-022-00139-w>

My friends, can your heart stand the shocking facts about graverobbers from outer space?: Cambridge Core ~ *An approximation to determine the source of the WOW! Signal:*

<https://www.cambridge.org/core/journals/international-journal-of-astrobiology/article/an-approximation-to-determine-the-source-of-the-wow-signal/4C58B6292C73FE8BF04A06C67BAA5B1A>

Universe Today ~ *A new Quantum Technique Could Enable Telescopes the Size of Planet Earth:*

<https://www.universetoday.com/155841/a-new-quantum-technique-could-enable-telescopes-the-size-of-planet-earth/>

Radio2Space ~ *SPIDER 300A installed near Sardinia Radio Telescope (SRT):*

<https://www.radio2space.com/portfolio/spider-300a-installed-near-sardinia-radio-telescope-srt/>

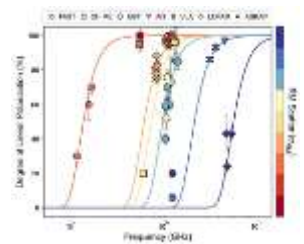

Science Near Me ~ *On the Science Near Me website, a simple search tool lets you look for things like nearby science festivals, planetarium events, citizen science projects from SciStarter, science policy forums, star-gazing events and more. There are events and programs for all ages and all kinds of interests on Science Near Me — head to the website and see what you find!*: <https://sciencenearme.org/>



Society of Amateur Radio Astronomers ~ SARA has a YouTube channel at: <https://www.youtube.com/channel/UC-SzptAQZ-20c9CkRb9ZPpw>



McGill University ~ *LWA Antenna installation on Marion Island, one-half way between the southern tip of South Africa and Antarctica*: [https://www.youtube.com/watch?v=053\\_ERXL\\_9k](https://www.youtube.com/watch?v=053_ERXL_9k)

Universe Today ~ *Even if you can't see Auroras, You Can Sometimes Hear Them. Here's What They Sound Like*: <https://www.universetoday.com/156123/even-if-you-cant-see-auroras-you-can-sometimes-hear-them-heres-what-they-sound-like/>

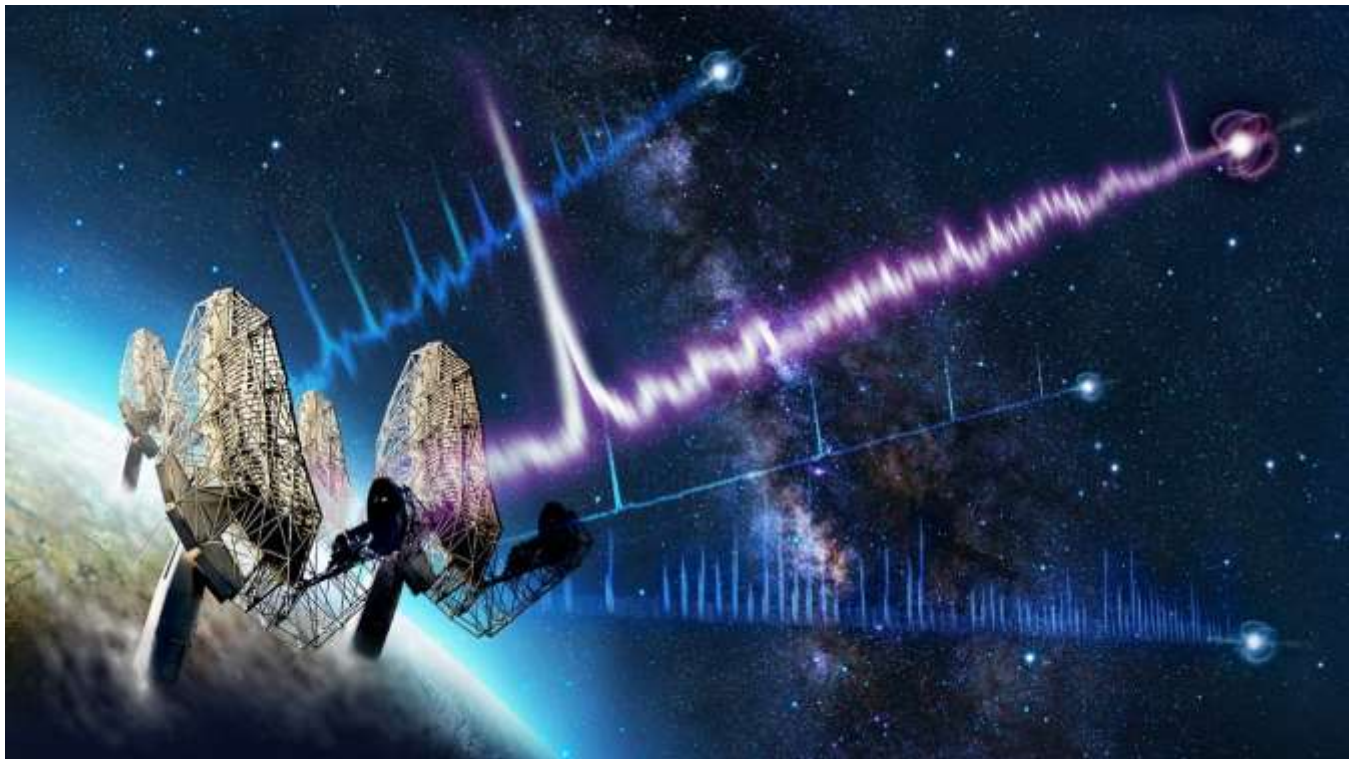

Universe Today ~ *A Pulsar has Been Found Turning so Slowly Astronomers Didn't Even Think it was Possible: Once Every 76 Seconds*: <https://www.universetoday.com/156096/a-pulsar-has-been-found-turning-so-slowly-astronomers-didnt-even-think-it-was-possible-once-every-76-seconds/> . See also below.

Science News ~ *A newfound, oddly slow pulsar shouldn't emit radio waves — yet it does. The slowpoke pulsar sits in our galaxy, roughly 1,300 light-years away*: <https://www.sciencenews.org/article/pulsar-radio-waves-neutron-star-astronomy>

Technical Knowledge & Education: (May-June 2022)

Sierra Circuits ~

- ⚙️ 8 Soldering Tips To Watch Out For: <https://www.protoexpress.com/blog/8-soldering-tips-to-watch-out-for/>
- ⚙️ A Practical Guide to Soldering Flux: <https://www.protoexpress.com/blog/guide-soldering-flux/>

Community of European Solar Radio Astronomers (CESRA) ~ *LOFAR size and shape measurements of solar metric radio burst sources:*

<https://www.astro.gla.ac.uk/users/eduard/cesra/?p=3260>

Signal Integrity Journal ~ *Assembling an EMC Troubleshooting Kit: Radiated Immunity:*

<https://www.signalintegrityjournal.com/blogs/17-practical-emc/post/2485-assembling-an-emc-troubleshooting-kit-radiated-immunity>

Axiv.org ~ *Fast Radio Bursts:* <https://arxiv.org/abs/2203.14198>

EWeb ~ *Detecting Radiation with the Geiger Counter:*

<https://www.eeweb.com/detecting-radiation-with-the-geiger-counter/>

Coilcraft ~ *Using Baluns and RF Components for Impedance Matching:*

[https://www.coilcraft.com/getmedia/ebe04fb9-dede-42c0-bcd2-ddfa3f66994a/Doc1077\\_Baluns\\_and\\_Impedance\\_Matching.pdf](https://www.coilcraft.com/getmedia/ebe04fb9-dede-42c0-bcd2-ddfa3f66994a/Doc1077_Baluns_and_Impedance_Matching.pdf)

Rohde & Schwarz ~

- ⚙️ *Understanding phase noise fundamentals:* [https://www.rohde-schwarz.com/us/products/test-and-measurement/analyzers/signal-spectrum-analyzers/white-paper-understanding-phase-noise-fundamentals-register\\_255143.html](https://www.rohde-schwarz.com/us/products/test-and-measurement/analyzers/signal-spectrum-analyzers/white-paper-understanding-phase-noise-fundamentals-register_255143.html)
- ⚙️ *Understanding phase noise measurement techniques:* [https://www.rohde-schwarz.com/us/products/test-and-measurement/analyzers/signal-spectrum-analyzers/white-paper-understanding-phase-noise-measurement-techniques-register\\_255398.html](https://www.rohde-schwarz.com/us/products/test-and-measurement/analyzers/signal-spectrum-analyzers/white-paper-understanding-phase-noise-measurement-techniques-register_255398.html)

UK Radio Astronomy Association ~ *Cosmic Ray Detection:* <https://ukraa.com/32-cosmic-ray-detection>

Community of European Solar Radio Astronomers (CESRA) ~ *Density Turbulence and the Angular Broadening of Outer Heliospheric Radio Sources at High Latitudes and in the Ecliptic Plane:* <https://www.astro.gla.ac.uk/users/eduard/cesra/?p=3278>

Springer Link ~ *Extreme solar events:*

<https://link.springer.com/article/10.1007/s41116-022-00033-8>

SciStarter.org ~ *Interactive NASA Space Physics Ionosphere Radio Experiments:*

<https://scistarter.org/interactive-nasa-space-physics-ionosphere-radio-ex>

Radio Astronomy ~ *Projects with JRT: Job's Radio Telescope 1.5-1.9 meter:*

<https://jgeheniau.wixsite.com/radio-astronomy>

SciStarter.org ~ *GAVRT Radio Astronomy Project:* <https://scistarter.org/gavrt-radio-astronomy-project>

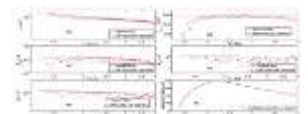
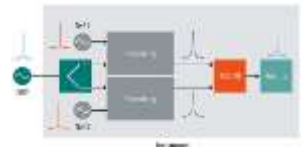
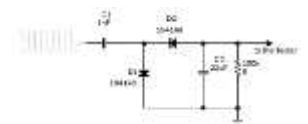
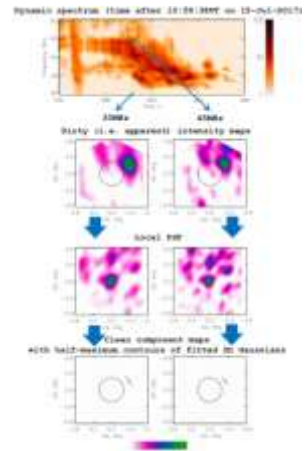

Recom ~ AC/DC Book of Knowledge: <https://recom-power.com/en/support/resource-library/book-of-knowledge/ac-dc-book-of-knowledge/ac-dc-book-of-knowledge.html>

Sierra Circuits ~ *How to Determine the Impedance of a Circuit*:  
<https://www.protoexpress.com/blog/how-to-determine-impedance-circuit/>

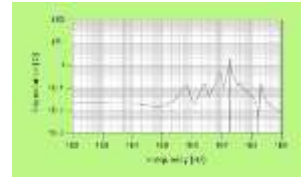

Signal Integrity Journal ~ *Practical EMC: Choosing an Affordable Spectrum Analyzer*:  
<https://www.signalintegrityjournal.com/blogs/17-practical-emc/post/2613-choosing-an-affordable-spectrum-analyzer>

Microwave Product Digest ~ *Detangling DoD's Cable and Connector Standards*:  
<https://www.mpdigest.com/2022/05/24/detangling-dods-cable-and-connector-standards/>



Society of Amateur Radio Astronomers, Youtube video ~ *Radio Telescope Observation Party: Tutorial on the Green Bank 20-meter Radio Telescope with Stephen Tzikas*: [https://www.youtube.com/watch?v=qq\\_4zzR8H64](https://www.youtube.com/watch?v=qq_4zzR8H64)

## Announcements: May-June 2022

With the end of COVID restrictions in many countries, the CESRA Board is currently considering the organization of CESRA Workshop around spring/summer 2023. We invite proposals to organize this meeting, to be submitted by July 15, 2022, to the CESRA President (cc to CESRA Board Secretary). For background information, please see the previous CESRA workshops here: [http://cesra.net/?page\\_id=71](http://cesra.net/?page_id=71)

Proposals (not more than 2 pages) are expected to include the following information:

- 1) The composition of the local organizers' team and existing experience in meeting organization;
- 2) Information about the meeting location, meeting dates and their flexibility, the meeting venue and its accessibility. Why do you think the meeting location is attractive to CESRA members?
- 3) Available infrastructure for the meeting (i.e., main room capabilities, possible availability of side rooms for Board meetings, space for poster sessions, etc.);
- 4) A rough estimate of budgetary balance (overall meeting cost vs. registration fee + possible sponsorships);
- 5) CESRA meetings normally attract 70-110 participants in total. An idea of available lodging (hotels, B&Bs, student dormitories) at close, or relatively close, proximity to the meeting location and an estimate of prices;
- 6) Your ideas / suggestions / preliminary assessment for getting financial support for the meeting and for providing financial support to students, young postdocs, and colleagues from underprivileged countries;
- 7) A rough idea of a tentative social programme;
- 8) Any ideas or facilities for outreach or media activities aiming at increasing the visibility of the meeting at national and international levels, and any plans for involving other national groups or individuals with expertise in solar radio physics;
- 9) Anything else, beyond the above, that you deem interesting or notable for the meeting to be organized by your team.
- 10) While we anticipate a face-to-face CESRA workshop, please state whether proposers will be able/interested to organize a fully online workshop or a hybrid (partially online) workshop in case a fully face-to-face experience will not be possible.

---

#### ESWW2022 CALL-FOR-ABSTRACTS

The submission system for the abstracts in one of the sessions is now open. The deadline for submission is 1st July 2022, included. The submission system with details on the sessions and instructions is available here: [https://www.stce.be/esww2022/program/sessions\\_withlist.php](https://www.stce.be/esww2022/program/sessions_withlist.php)

#### ESWW2022 CALL-FOR-TOPICAL DISCUSSION MEETINGS

The submission system to propose a topical discussion meeting (TDM) is now open. The deadline for submission is 1st July 2022, included. The submission system with details and instructions is available here: <https://www.stce.be/esww2022/call4tdm.php>

#### ESWW2022 REGISTRATION OPENED

The registration system is now open and available (with details and instructions) here: <https://www.stce.be/esww2022/registration.php>. The deadline for early bird registration is 10th September 2022, included.

#### ESWW2022 FINANCIAL SUPPORT

Financial support can be provided to a limited number of participants from DAC-listed countries and students (PhD, Msc, Bsc). The deadline for application is 1st July 2022, included. More details and instructions are available here: <https://www.stce.be/esww2022/registration.php>

Best regards,

Mario Bisi (PC Chair) and Mateja Dumbovic (LOC Chair), on behalf of the ESWW2022 PC

---

# **16th International Symposium on Equatorial Aeronomy**

**16TH INTERNATIONAL SYMPOSIUM ON EQUATORIAL AERONOMY (ISEA-16)**  
during 12 - 16 September 2022 at Kyoto University (in person / virtual hybrid)

The International Symposium on Equatorial Aeronomy (ISEA) is held once in every three to four years. Researchers from the fields of atmosphere, ionosphere and magnetosphere gather together in ISEA to share new findings, discuss the current status, and identify topics for future research.

The 16th International Symposium on Equatorial Aeronomy (ISEA-16) will be held in person during 12 - 16 September 2022 at Kyoto University along with zoom virtual conference. We are pleased to announce that we have opened abstract submission through the website <https://www.rish.kyoto-u.ac.jp/isea16/>.

We are able to offer financial support for travel. Those who are interested in the financial support must submit their abstract by May 31, 2022. Also refer to the information about travel and visa application at our website. If you have any questions, please contact [isea16contact](mailto:isea16contact@rsh.kyoto-u.ac.jp) (at) [rsh.kyoto-u.ac.jp](https://www.rish.kyoto-u.ac.jp)

# 16th International Symposium on Equatorial Aeronomy

September 12-16, 2022

Hybrid Meeting

Zoom and Uji Campus, Kyoto University, Kyoto, Japan

*The International Symposium on Equatorial Aeronomy (ISEA) is held once every three to four years. Researchers from the fields of atmosphere, ionosphere, and magnetosphere gather together in ISEA to share new findings, discuss the current status, and identify topics for future research. The 16th ISEA will be held from September 12 to 16, 2022 at Research Institute for Sustainable Humanosphere, Kyoto University, Japan.*

- Session 1: Equatorial E- and F-region irregularities: Cause and effects
- Session 2: Longitudinal/hemispheric variation of equatorial electrodynamics
- Session 3: Atmosphere-ionosphere vertical coupling at low- and mid-latitudes
- Session 4: Space weather effects at low- and mid-latitudes
- Session 5: Recent advances in instrumentation and observation
- Session 6: Application of numerical techniques for aeronomy
- Session 7: Future trends, opportunities, and challenges in low-latitude aeronomy

## Scientific Organizing Committee

Mamoru Yamamoto (Kyoto Univ.) (Chair)  
Duggirala Pallamraju (PRL)  
Tzu-Wei Fang (NOAA)  
Jeffrey Klenzing (NASA)  
Fabiano Rodrigues (Univ. of Texas at Dallas)  
Marco Milla (PUCP)  
Danny Scipion (IGP)  
Claudia Stolle (IAP)

## Local Organizing Committee

Mamoru Yamamoto (Kyoto Univ.) (Chair)  
Hiroyuki Hashiguchi (Kyoto Univ.)  
Tatsuhiko Yokoyama (Kyoto Univ.)  
Koji Nishimura (Kyoto Univ.)  
Akinori Saito (Kyoto Univ.)  
Yuichi Otsuka (Nagoya Univ.)  
Michi Nishioka (NICT)  
Kornyaht Hozumi (NICT)  
Akimasa Yoshikawa (Kyushu Univ.)  
Susumu Saito (ENRI)



<http://www.rish.kyoto-u.ac.jp/isea16/>  
[isea16contact@rish.kyoto-u.ac.jp](mailto:isea16contact@rish.kyoto-u.ac.jp)

Supported by:  
International Exchange Program of National Institute of Information and Communications Technology (NICT)  
Research Institute for Sustainable Humanosphere (RISH), Kyoto University  
Joint Research Program of Institute for Space-Earth Environmental Research (ISEE), Nagoya University  
Society of Geomagnetism, Planetary and Space Sciences (SGEPSS)



[Register for ESWW2022](#)  
[Submit an abstract to a session](#)  
[Submit your Topical Discussion Meeting](#)  
[Announcement concerning the ESWW medals](#)



The ESWW is the main annual event in the European Space Weather calendar. It is an international meeting organized annually within the European Region in collaboration with prominent members of the European space weather community. It began as a forum for the European Space Weather community and has since grown into an international event with global attendance.

ESWW2022 will again adopt the central aim of bringing together the diverse groups in Europe working on different aspects of Space Weather and Space Climate: such as scientists, engineers, satellite operators, power grid technicians, communication and navigation specialists, people working in aviation, space weather service providers, STEM\* practitioners. The ESWW is highly interdisciplinary by nature and actively promotes investigation of new technologies and approaches e.g. machine learning in a space weather context.

ESWW is an excellent place to meet people, to exchange knowledge and ideas, to discuss the latest on solar activity, how space weather influences the earth environment and our technologies, and how to deal with space weather.

The ESWW2022 meeting will take place in Zagreb. The local organization is done by the [HVAR Observatory](#) and the [Solar-Terrestrial Centre of Excellence](#).







**K-Band Science Using the Green Bank Telescope  
19th – 21st September 2022, Green Bank, WV**

Green Bank Observatory (GBO) is planning a workshop on K-band science, past, present and future, covering science that has utilized/will utilize the Green Bank Telescope (GBT). The goals of this workshop are threefold:

1. Celebrate the success of prior observing campaigns and the K-band Focal Plane Array (KFPA), while encouraging use of the available archival data;
2. Poll the community on the science being done or proposed at K-band to establish if the GBT is able to meet those needs;
3. Seek community input on the future direction of K-band science and instrumentation at Green Bank.

Please use the form at <https://greenbankobservatory.org/science/meetings-and-workshops/current-future-k-band-workshop/> to pre-register for the conference. In July 2022 we will invite a shortlist of pre-registrants to attend the conference up to the capacity of the observatory site. We intend to provide virtual access to some portions of the workshop, although the exact format has yet to be determined



**SuperSID**  
*Collaboration of Society  
of Amateur Radio  
Astronomers and  
Stanford Solar Center*



- Stanford provides data hosting, database programming, and maintains the SuperSID website
- Society of Amateur Radio Astronomers (SARA) sells the SuperSID monitors for 48 USD to amateur radio astronomers and the funds are then used to support free distribution to students all over the world (image below as of Fall 2017)
- Jonathan Pettingale at SARA is responsible for building and shipping the SuperSID monitor kits: [SuperSID@radio-astronomy.org](mailto:SuperSID@radio-astronomy.org)
- SuperSID kits may be ordered through the SARA SuperSID webpage: <http://radio-astronomy.org/node/210>
- Questions about the SuperSID project may be directed to Steve Berl at Stanford: [steveberl@gmail.com](mailto:steveberl@gmail.com)
- Jaap Akkerhuis at Stanford is responsible for the SuperSID software and SARA has provided financial support for his efforts
- SuperSID website hosted by Stanford: <http://solar-center.stanford.edu/SID/sidmonitor/>
- SuperSID database: <http://sid.stanford.edu/database-browser/>
- The data is searchable by time, station, date, and multiple plots may be placed on the same graph for comparison.

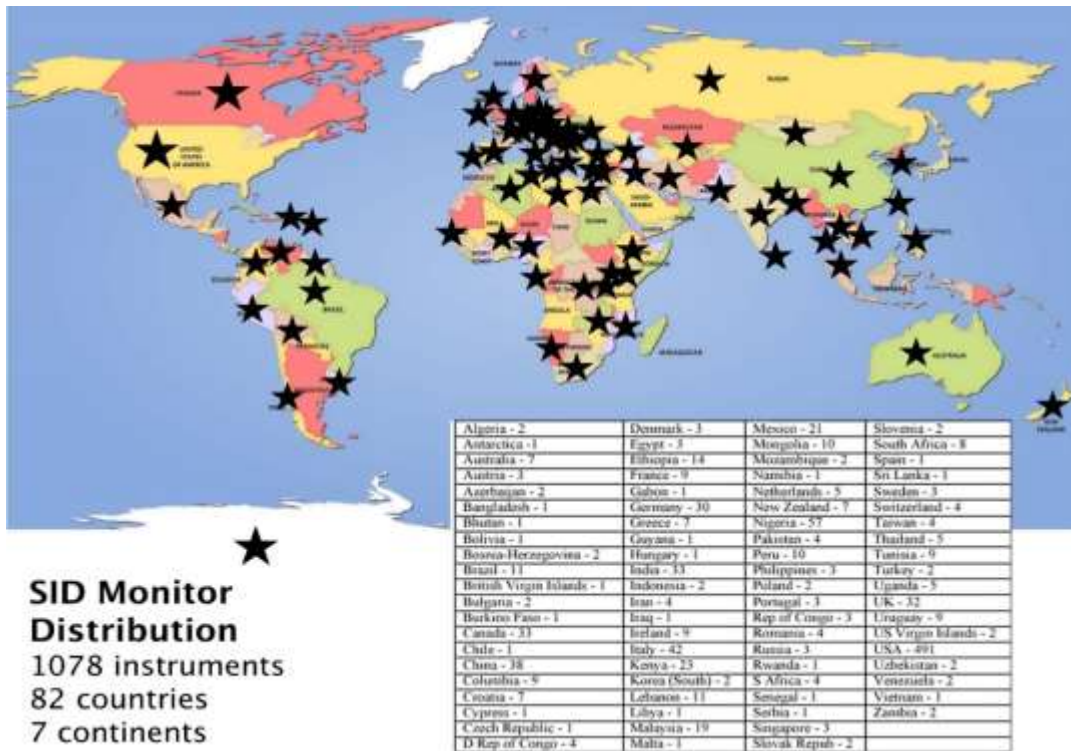

For official use only  
 Monitor assigned: \_\_\_\_\_  
 Site name: \_\_\_\_\_  
 Country: \_\_\_\_\_

## SuperSID Space Weather Monitor Request Form

<i>Your information here</i>				
Name of site/school (if an institution):				
Choose a site name: <b>(3-6 characters) No Spaces</b>				
Primary contact person:				
Email:				
Phone(s):				
Primary Address:	Name School or Business Street Street City <span style="float: right;">State/Province</span> Country <span style="float: right;">Postal Code</span>			
Shipping address, if different:	Name School or Business Street Street City <span style="float: right;">State/Province</span> Country <span style="float: right;">Postal Code</span>			
Shipping phone number:	<table border="1" style="width: 100%; border-collapse: collapse;"> <tr> <td style="width: 33%; height: 20px;"></td> <td style="width: 33%; height: 20px;"></td> <td style="width: 33%; height: 20px;"></td> </tr> </table>			
Latitude & longitude of site:	Latitude: _____ Longitude: _____			

**I understand that neither Stanford nor the Society of Amateur Radio Astronomers is responsible for accidents or injuries related to monitor use. I will assure that a surge protector and other lightning protection devices are installed if necessary.**

**Signature:** \_\_\_\_\_ **Date:** \_\_\_\_\_

*I will need:*

<i>What</i>	<i>Cost</i>	<i>How many?</i>
SuperSID distribution USB Power	\$48 (assembled)	
USB Sound card 96 kHz sample rate (or provide this yourself)	\$40 (optional)	
Antenna wire (120 meters) (or you can provide this yourself)	\$23 (optional) with connectors attached and tested	
RG 58 Coax Cable (9 meters) (or provide this yourself)	\$14 (optional) with connectors attached and tested	
Shipping	US \$12 Canada & Mexico \$40 all other \$60	
	<b>TOTAL</b>	\$

\_\_\_\_\_ I have included a \$\_\_\_\_\_ check (payable to SARA)

\_\_\_\_\_ I will make payment thru [www.paypal.com](http://www.paypal.com) to [treas@radio-astronomy.org](mailto:treas@radio-astronomy.org)

or

\_\_\_\_\_ If you are a Minority-serving institution, in a Developing or economically deprived nation, and/or you are using the monitor with students for educational purposes, you may qualify for obtaining a monitor at reduced or no cost. Check here if you wish to apply for this designation. Then tell us how you want to use the SuperSID monitor. Include type of site, number of students involved, whether public or private school, grade levels, etc. and describe your program. The goal of the SuperSID project is to provide as many students with systems as possible. If you are able to pay for a system, even if you qualify for a free one, please do so and help support our goal.

---

---

---

---

For more details on the Space Weather Monitor project, see: <http://sid.stanford.edu>

To set up a SuperSID monitor you will need:

- <sup>1</sup> Access to power and an antenna location that is relatively free of electric interference (could be indoors or out)
- <sup>2</sup> A **PC\*\*** with the following minimal specifications:
  - a. A sound card that can record (sample) up to 96 kHz, or a USB port to connect such a sound card (for North and South America)
    - i. All other countries can use AC97 sound card with 48 kHz record (sample) rate. Most computers made after 1997 will have AC97.
  - b. Windows 2000 or more recent operating system
  - c. 1 GHz Processor with 128 mb RAM
  - d. Ethernet connection & internet browser (desirable, but not required)
  - e. Standard keyboard, mouse, monitor, etc.
- <sup>3</sup> An inexpensive antenna that you build yourself. You'll need about 120 meters (400 feet) of **insulated** wire. Solid wire is easier to wind than stranded. Magnet wire will work but be more fragile. You can use anything from #18 to #26 size wire. The antenna frame can be made of wood, PVC pipe, or similar materials. We'll provide instructions. You can purchase the wire from us or obtain your own.
- <sup>4</sup> RG58 coax cable with a BNC connector at one end to run from the antenna to the SuperSID receiver. 9 meters is recommended, but the length will depend on where you place the antenna. You can purchase the coax from us or obtain your own.
- <sup>5</sup> Surge protector and other protection against a lightning strike

---

Return this form to: [SuperSID@radio-astronomy.org](mailto:SuperSID@radio-astronomy.org)

or mail to: SARA  
Brian O'Rourke, SARA Treasurer  
337 Meadow Ridge Rd,  
Troy, VA 22974-3256

## Announcing Radio JOVE 2.0

The Radio JOVE Team



Radio JOVE students and amateur scientists from around the world observe and analyze natural radio emissions of Jupiter, the Sun, and our galaxy using their own easy to construct radio telescopes.

Our Project announces Radio JOVE 2.0, where participants assemble a 16-24 MHz radio spectrograph to observe solar, Jupiter, Galactic, and Earth-based natural radio emissions and share their observations with fellow participants.

### In the Beginning

Radio JOVE started as a NASA sponsored educational outreach project in 1999. We developed a radio telescope kit suitable for receiving signals from Jupiter, the Sun, the Galaxy, and Earth-based radio emissions. The original kit comprised a radio receiver (RJ1.1) and a dual dipole antenna for 20.1 MHz. An important goal was to teach electronic principles including how to build, solder, and assemble the radio receiver and antenna.

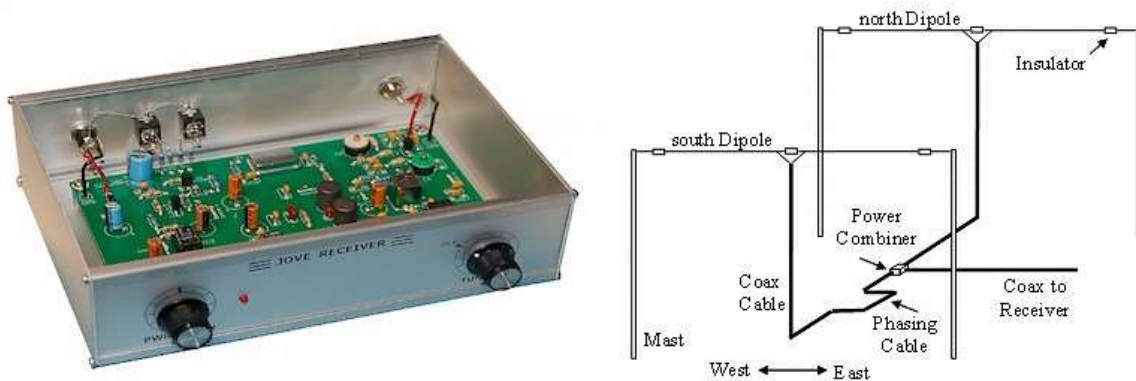

Figure 1. A Radio JOVE RJ1.1 receiver and a schematic of the dual-dipole antenna.

In addition to the hardware, three software packages were developed. These were Radio Jupiter Pro (Jupiter emission prediction program), Radio-SkyPipe (strip chart program) and Radio Sky Spectrograph (control and display of radio spectrograph data).

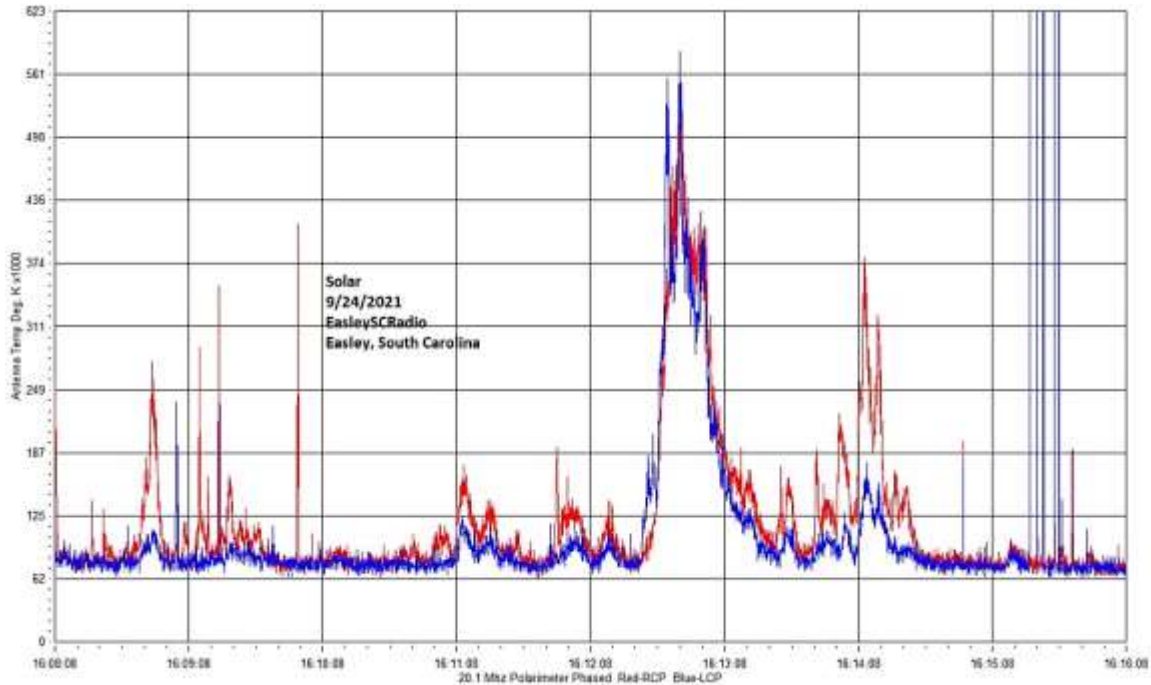

Figure 2. A SkyPipe strip chart showing multiple solar bursts using a JOVE receiver. John Cox, SC.

### The Growth of Radio JOVE

As of Autumn 2021, over 2,500 kits have been sold at cost to schools and individuals around the world. Thousands of data submissions from observers have been made to the Radio JOVE data archive.

The Radio JOVE web site has always provided a wealth of information describing observation methods and various educational materials intended to teach radio astronomy techniques and scientific methods. Biannual newsletters are produced and several telephone help sessions are held each year.

A sub-group of experienced observers known as the Spectrograph Users Group (SUG) evolved from the core JOVE group. These observers developed data collection and analysis techniques using more advanced equipment and techniques. SUG members have contributed to articles published in peer-reviewed scientific journals. This group remains active under the Radio JOVE listserv at <https://groups.io/g/radio-jove/>.

### Moving Forward with New Technology

In the past, Radio JOVE provided the hands-on experience of building a radio kit. We have many RJ1.1 receivers in operation successfully contributing scientifically valuable data. It has, however, become increasingly difficult to obtain parts for the RJ1.1 receiver kits and we therefore decided to replace the RJ1.1 receiver with a new SDR-based design for the receiver portion of our radio telescope kits. While we continue to support the hardware and software for the original RJ1.1 receivers, the only kits now available for purchase from Radio JOVE contain this newly designed system.

In recent years, new technologies have made software defined radios (SDRs) ever more affordable. These radios can operate on a single frequency like the original JOVE receiver but can also generate spectrograms which depict radio activity as a function of both time and frequency. Such displays offer new insights into our studies of the Sun, Jupiter, the Galaxy, and both natural and artificial Earth-based radio emissions.

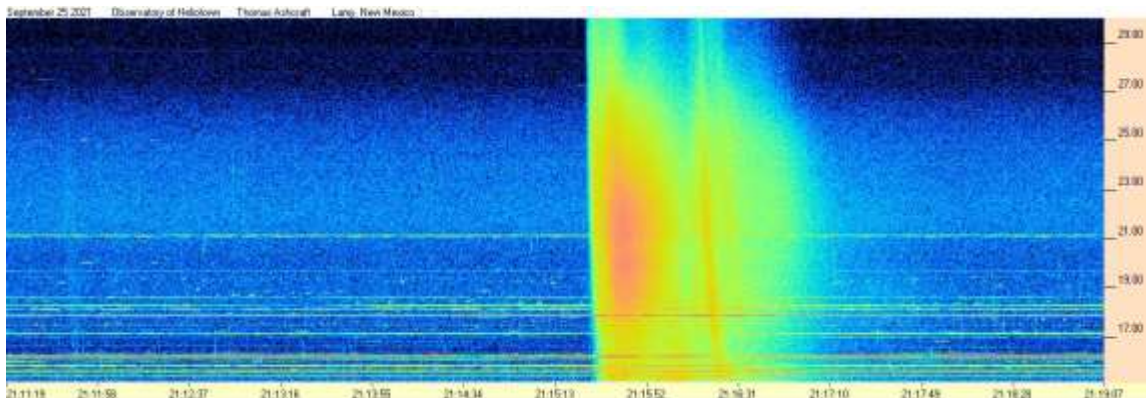

Figure 3. Radio spectrogram showing multiple solar bursts received by Tom Ashcraft in New Mexico. Horizontal scale is time and the vertical scale is frequency. Amplitude is displayed using different colors corresponding to the strength of signals.

Radio JOVE continues to sell radio telescope packages including an antenna, receiver, and software; however, the receiver is now a commercially built SDR.



Figure 4. The JOVE team has had considerable success with the SDRPlay RSP1A unit and will provide support for using this instrument for our radio astronomy program. Not all SDR types can be supported, but it is our intent to provide support for some other SDRs as they become available during this period of rapid SDR development.

It continues to be our goal to introduce new observers to the scientific method and help them experience the thrill of receiving cosmic radio signals. Through a series of educational training modules and observing and analysis projects we aim to guide new observers to levels where they can contribute to Citizen Science projects.

We continue to support our large user base that uses JOVE RJ1.1 receivers – both in terms of technical support for the receivers but also with new and exciting observing projects for both RJ1.1 and SDR users.

We welcome both new and experienced observers to the JOVE 2.0 program as we share the excitement of receiving, studying, and understanding radio signals from our corner of the galaxy.

Please see the Radio JOVE web site at <https://radiojove.gsfc.nasa.gov> for more information.





## RADIO JOVE 2.0 RADIO TELESCOPE KIT ORDER FORM

Order Online using PayPal™

\* \* \* Please allow 2 to 3 weeks for delivery. \* \* \*

**IMPORTANT:** Before you order the Jove receiver kit and/or the antenna kit, we suggest that you read the on-line manuals. You will need to provide additional materials and tools to complete the antenna. The cost of additional materials for the antenna support structure (masts, etc.) may be in the range of US\$75 to US\$100. Also note that the optimal antenna height can be up to 20ft, depending upon your latitude.

<p><b>Item # RJK2u</b> – Complete 2.0 Kit: Receiver + Unbuilt Antenna Kit + Software</p> <p>This kit includes an SDRplay RSP1A, USB Cable, SMA/BNC cable, F-adapter, unbuilt Antenna Kit (RJA), printed assembly manuals, and Radio-Sky Spectrograph (RSS) software.</p> <p>Note: Kit does not include antenna support structure.</p> <p><b>Price: \$215 + Shipping (See reverse for shipping)</b></p>	<p><b>Item # RJK2p</b> – Complete 2.0 Kit: Receiver + Professionally Built Antenna Kit + Software</p> <p>This kit includes an SDRplay RSP1A, USB Cable, SMA/BNC cable, F-adapter, Professionally Built Antenna Kit (RJA2), printed assembly manuals, and Radio-Sky Spectrograph (RSS) software.</p> <p>Note: Kit does not include antenna support structure.</p> <p><b>Price: \$384 + Shipping (See reverse for shipping)</b></p>
<p><b>Item # RJA</b> – Unbuilt Antenna Kit</p> <p>The RJA Radio JOVE Antenna Kit includes a printed construction manual, stranded copper easy-to-solder antenna wire, ceramic insulators, RG-59 easy-to-solder coax cable, screw-on Fconnectors, and a power combiner.</p> <p>Note: Kit does not include antenna support structure. Assembly requires a soldering gun and other tools.</p> <p><b>Price: \$90 + Shipping (See reverse for shipping)</b></p>	<p><b>Item # RJA2</b> – Professionally Built Antenna Kit</p> <p>The RJA2 Radio JOVE Antenna Kit includes a printed installation manual, two professionally assembled dipole antennas constructed of #14 Copperweld wire with Budwig center insulators and center support rope attachment points, high quality RG-6 coax with pre-installed commercial grade connectors, and a power combiner.</p> <p>Note: Kit does not include antenna support structure.</p> <p><b>Price: \$249 + Shipping (See reverse for shipping)</b></p>
<p><b>Item # LTJ2</b> – Listening to Jupiter, 2nd Ed. by R. S. Flagg</p> <p>PDF download of Richard Flagg's book "Listening to Jupiter, 2nd Ed., 2005". The file is downloaded from a secure website.</p> <p><b>Price: \$10 + \$0 shipping (PDF file download)</b></p>	<p><b>Item # RJR2</b> – Radio JOVE 2.0 Receiver-Only Kit</p> <p>This kit includes one SDRplay RSP1A SDR receiver, USB Cable, SMA/BNC cable, and F-adapter, printed assembly manuals, and Radio-Sky Spectrograph (RSS) software.</p> <p><b>Price: \$135 + Shipping (See reverse for shipping)</b></p>

# RADIO JOVE 2.0 RADIO TELESCOPE KIT ORDER FORM (continued)

Order Online at [https://radiojove.net/kit/order\\_form.html](https://radiojove.net/kit/order_form.html) OR  
 Complete this form and mail with payment

Payment may be made by Credit Card via PayPal™, U.S. Check, U.S. Money Order, International Money Order in U.S. funds drawn on a U.S. bank, or Western Union Money Transfer made payable to **The Radio JOVE Project**. No bank-to-bank wire transfers are accepted. Purchase Orders are accepted from U.S. Institutions.

**Send to:** The Radio JOVE Project  
 1301 East Main St  
 MTSU Box 412  
 Murfreesboro, TN 37132, USA  
 email: [chiggins@mtsu.edu](mailto:chiggins@mtsu.edu)  
 FEIN: 20-5239863

Item	Description	Quantity	Item Price	Shipping (see below)	Subtotal
RJK2u	Complete Radio JOVE 2.0 Kit Receiver + unbuilt Antenna		\$215		
RJK2p	Complete Radio JOVE 2.0 Kit Receiver + Professionally Built Antenna		\$384		
RJA2	Professionally Built Antenna-Only Kit		\$249		
RJA	Unbuilt Antenna-Only Kit		\$90		
RJR2	Receiver-Only Kit		\$135		
LTJ2	Listening to Jupiter, 2 <sup>nd</sup> Ed., by R.S. Flagg (PDF download)		\$10	\$0	
<b>Total:</b>					

**Shipping Fees for Radio JOVE:** We ship all packages using USPS Priority Mail flat rate boxes.  
 U.S.A.: \$17.00  
 Canada: \$57.00  
 All Other International Shipping: \$85.00

**Ship to:** (Please print clearly)

Name: \_\_\_\_\_  
 Address: \_\_\_\_\_  
 City, State, Postal Code: \_\_\_\_\_  
 Province, Country: \_\_\_\_\_  
 Email: \_\_\_\_\_

Visit the Radio JOVE web site and fill out the team application form at [https://radiojove.net/sign\\_up\\_form.php](https://radiojove.net/sign_up_form.php) even if you are just an interested individual so that you can receive important information about kit updates, online services, and activities within the project as they occur!



# The British Astronomical Association

A company limited by guarantee  
Registered Charity No. 210769

Burlington House, Piccadilly, London, W1J 0DU

Telephone: 020 7734 4145

Fax No.: 020 7439 4629

Email: [office@britastro.org](mailto:office@britastro.org)

Website: [www.britastro.org](http://www.britastro.org)



Please send all reports and observations to John Cook: [jacook@jacook.plus.com](mailto:jacook@jacook.plus.com)

## John Cook's VLF Report

**BAA Radio Astronomy Section**, Director: Paul Hearn

**EDITOR'S NOTE:** Because of their extensive nature the solar flare/VLF Tables have been left out of this issue. Readers needing the additional information should contact John Cook at the address above.

**RADIO SKY NEWS**

**2022 MARCH**

### VLF SID OBSERVATIONS

2022 March has seen the highest SID count recorded since 2015 October, including the second X-flare of solar cycle 25. The increasing day length in March helped to catch the X1.3 flare peaking around 17:40UT on the 30<sup>th</sup>. This was well timed for the north-south and westerly paths, and just caught the local sunset eastwards at 23.4kHz. This recording by Paul Hyde shows the event well:

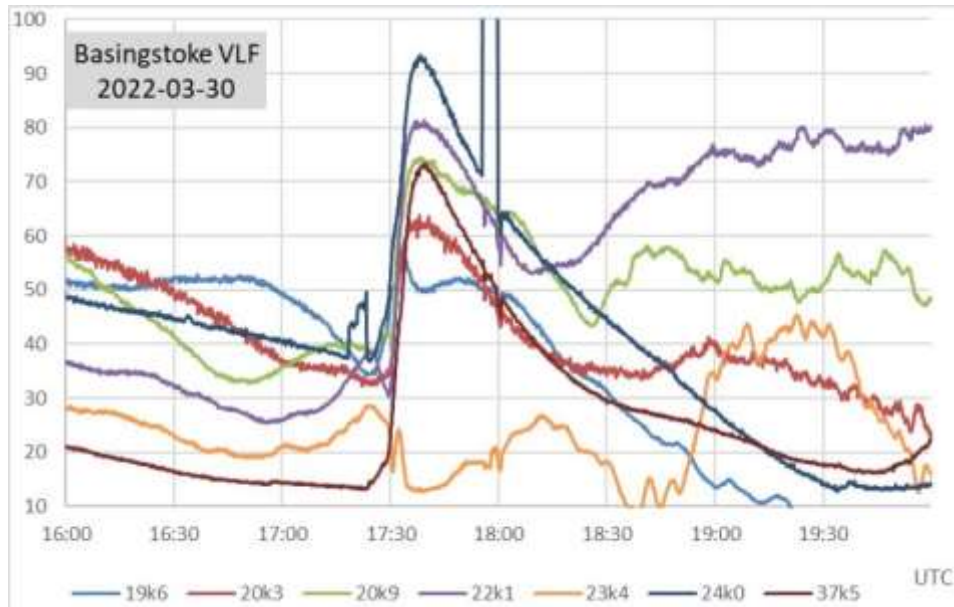

Most of these signals show a fast rise-time 'shark's fin' SID, while 19.6kHz (light blue) has a gentle 'spike and wave' response. This is also seen at 23.4kHz before the recovery gets lost into the sunset.

This was preceded by a series of multiple peaked flares that have taken some time to sort out. Simply taking the timings from our SID recordings does not match the X-ray flare timings shown in the SWPC bulletin; hence the gaps shown in the tables at the end of this report. I have put a '\*' in the magnitude column to indicate these events. The recording by Mark Prescott shows some of these SIDs, followed by Paul Hyde's recording:

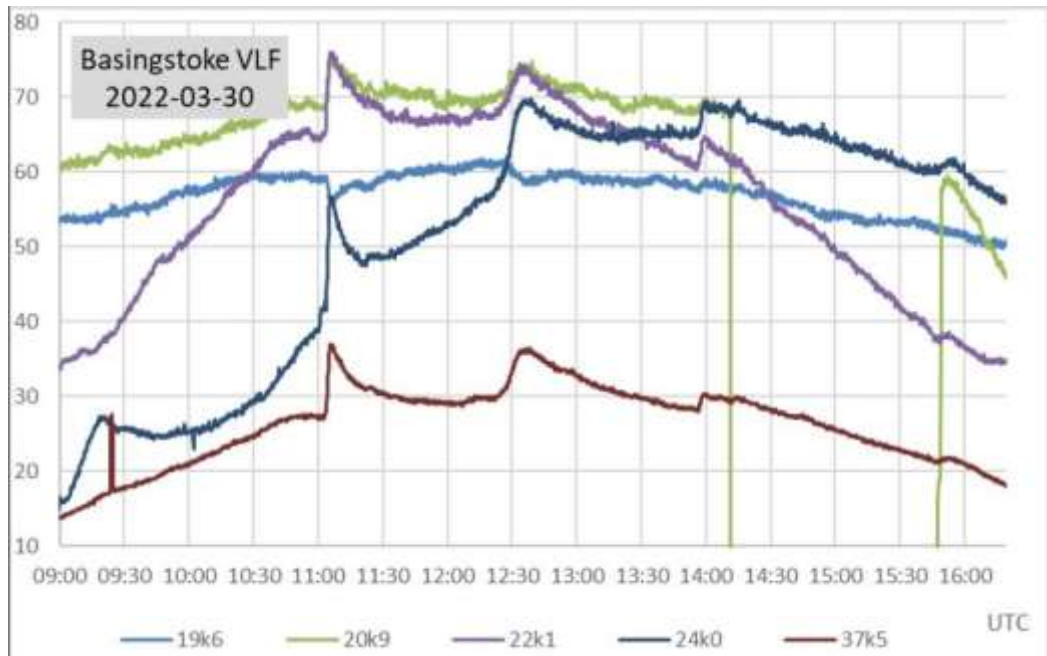
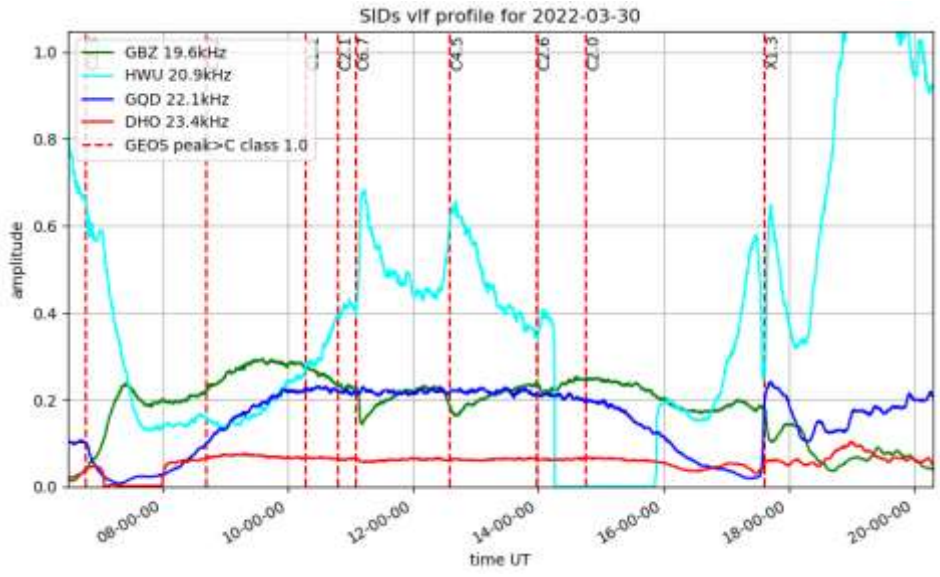

In most of these traces the SID at 11:05UT is the strongest event, but is not listed by the SWPC. Looking at graphs of the X-ray flux, it appeared to be from a flare of about C8 magnitude, the highest peak in an event running from about 10:20 and merging into the C4.5 flare listed after 12:30.

An even more complex train of flares was recorded late on the 28<sup>th</sup>. The GOES graphs show the X-ray flux intensity gradually rising from about 16:00UT followed by a number of peaks before falling again by 18:30. The

SWPC list just shows the C9.8 peak at 17:15, but the flux intensity appears to have reached M1 shortly afterwards. The M4.0 flare earlier in the morning was more isolated, and much easier to see. The majority of this activity was from active region AR12975, a complex group with numerous individual sunspots, crossing the central meridian over this period. The recording by Mark Prescott shows many of these events:

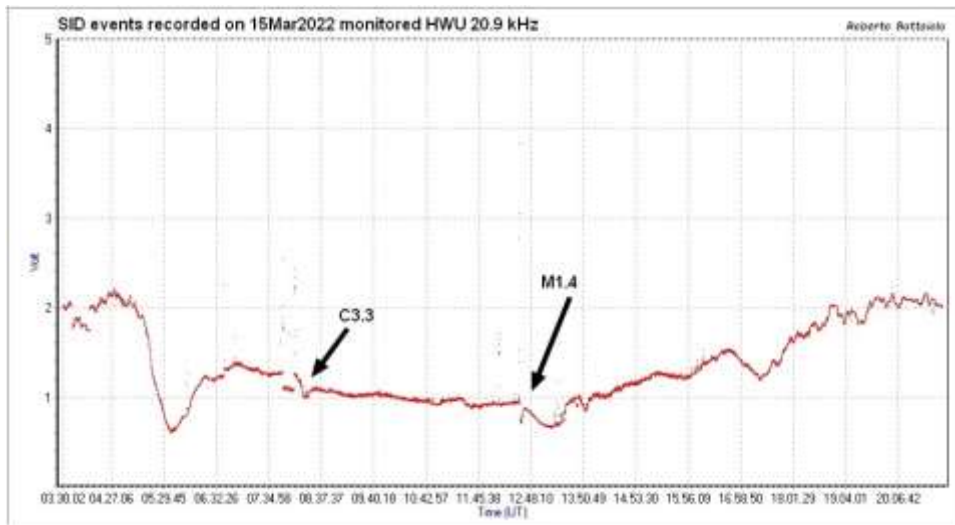
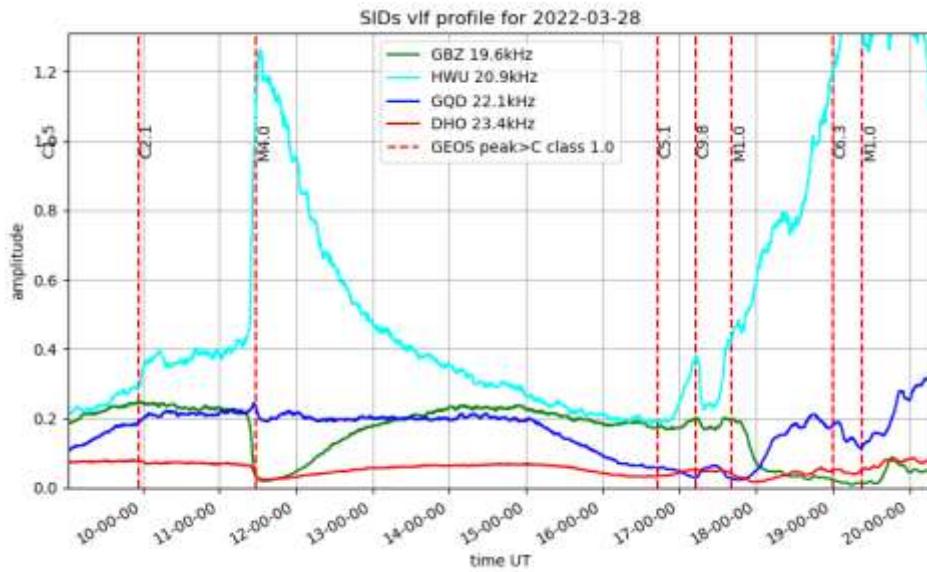

This recording by Roberto Battaiola on the 15<sup>th</sup> shows the M1.4 and C3.3 flares on a rather noisy signal at 20.9kHz. A very small dip in the signal is just visible matching the C1.6 flare at 11:30, but is not an obvious SID.

## SOLAR EMISSIONS

Colin Briden and Colin Clements recorded strong solar emissions. Colin Briden monitored 28MHz and noted strong type III/2 bursts on the 30<sup>th</sup>. The first of these, shown on the next page, was at about 13:15UT, and does not appear to directly match any of the flares listed by SPWC. It appears to have three peaks increasing in amplitude over a period of about 20 seconds. A pair of bursts were then seen starting at 14:00, each lasting about 15 seconds and about one minute apart. These are a good match for the first two peaks of the C2.6 flare shown in the charts by Paul Hyde and Mark Prescott.

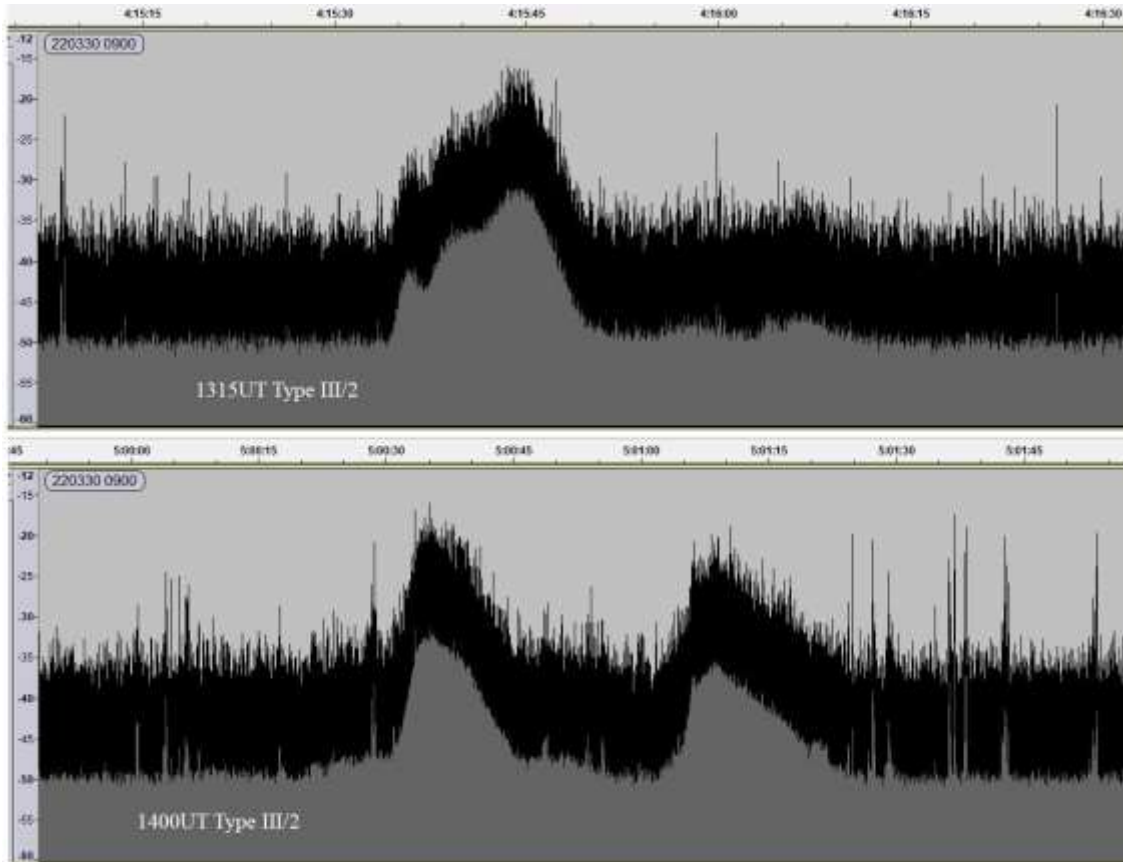

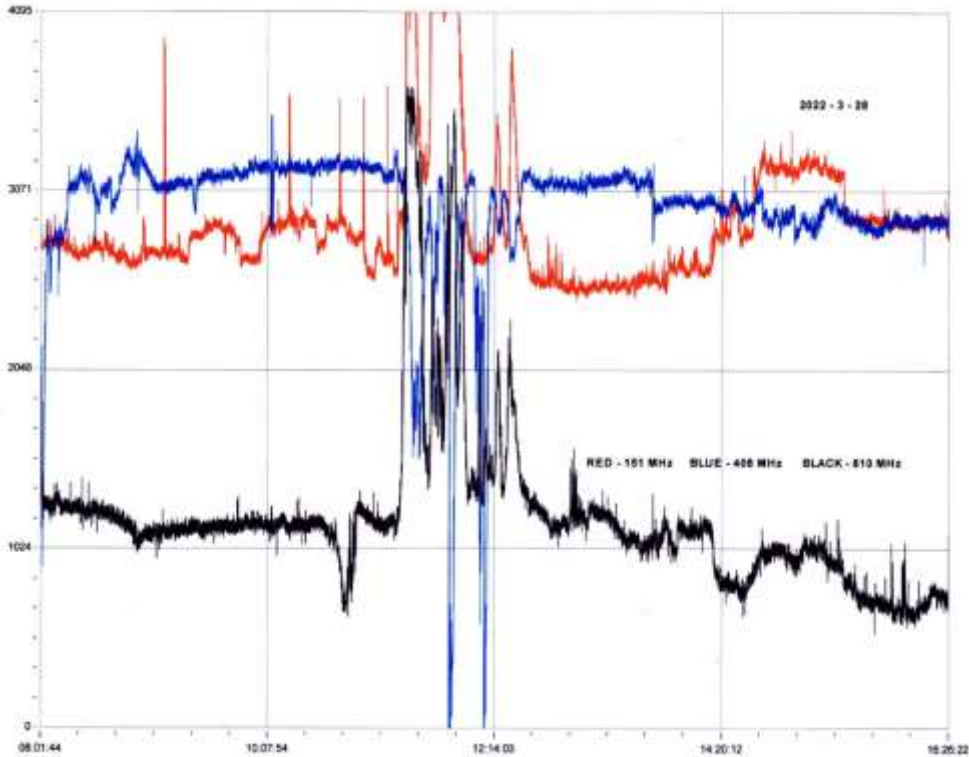

This recording by Colin Clements shows noise bursts at 151, 408 and 610MHz well timed to match the M4.0 flare at 11:30UT on the 28<sup>th</sup>. The blue trace is 408MHz and appears to show a drop in noise during the flare, an unusual feature that we have not recorded before. Both 610 and 151MHz have the expected increase in noise level. Colin Clements also recorded noise bursts on the 22<sup>nd</sup> and 23<sup>rd</sup>.

### MAGNETIC OBSERVATIONS

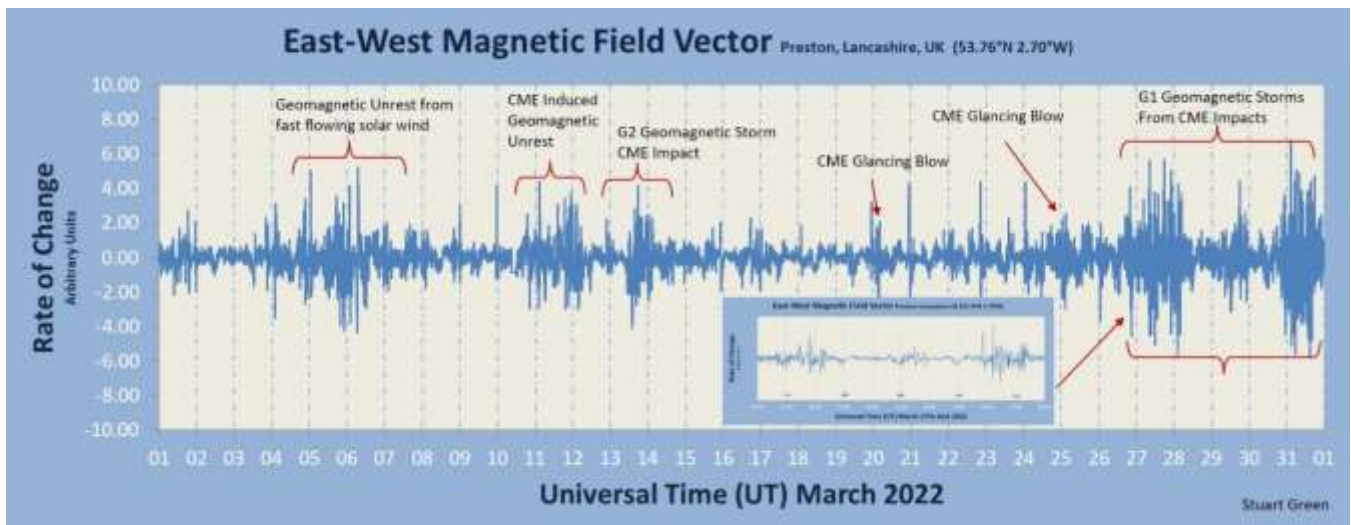

Stuart Green’s summary of the month’s magnetic activity shows a combination of high speed winds and CME impacts. A CME shown in satellite images from the 10<sup>th</sup> arrived with a significant impact at about 10:45UT on the 13<sup>th</sup>, shown in the recording by Roger Blackwell:

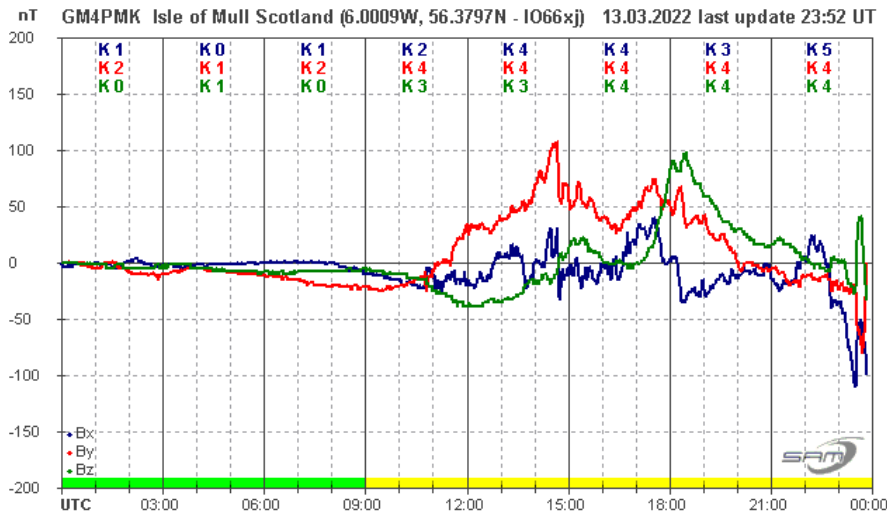

A small transient in the Bx signal (blue trace) appears to mark the impact, followed immediately by a very turbulent disturbance in all three sensors. This only lasted until about 03:00 in the following morning.

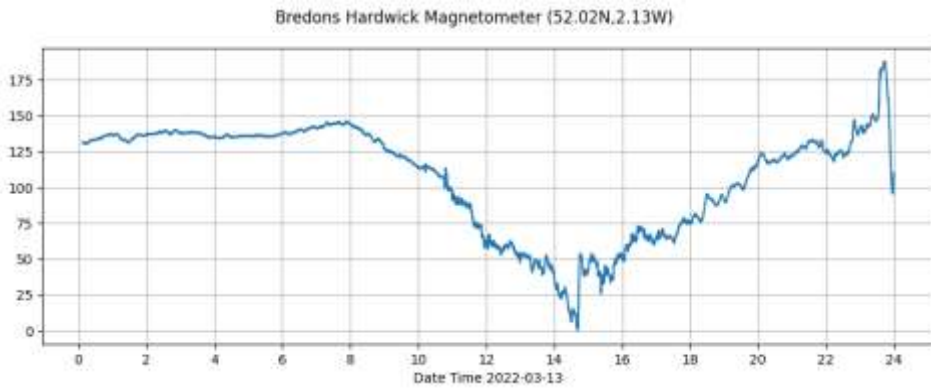

A similar transient at about 11UT is also present in this recording by Callum Potter. This is from a single axis sensor, mounted horizontally, reducing the turbulence seen during the afternoon.



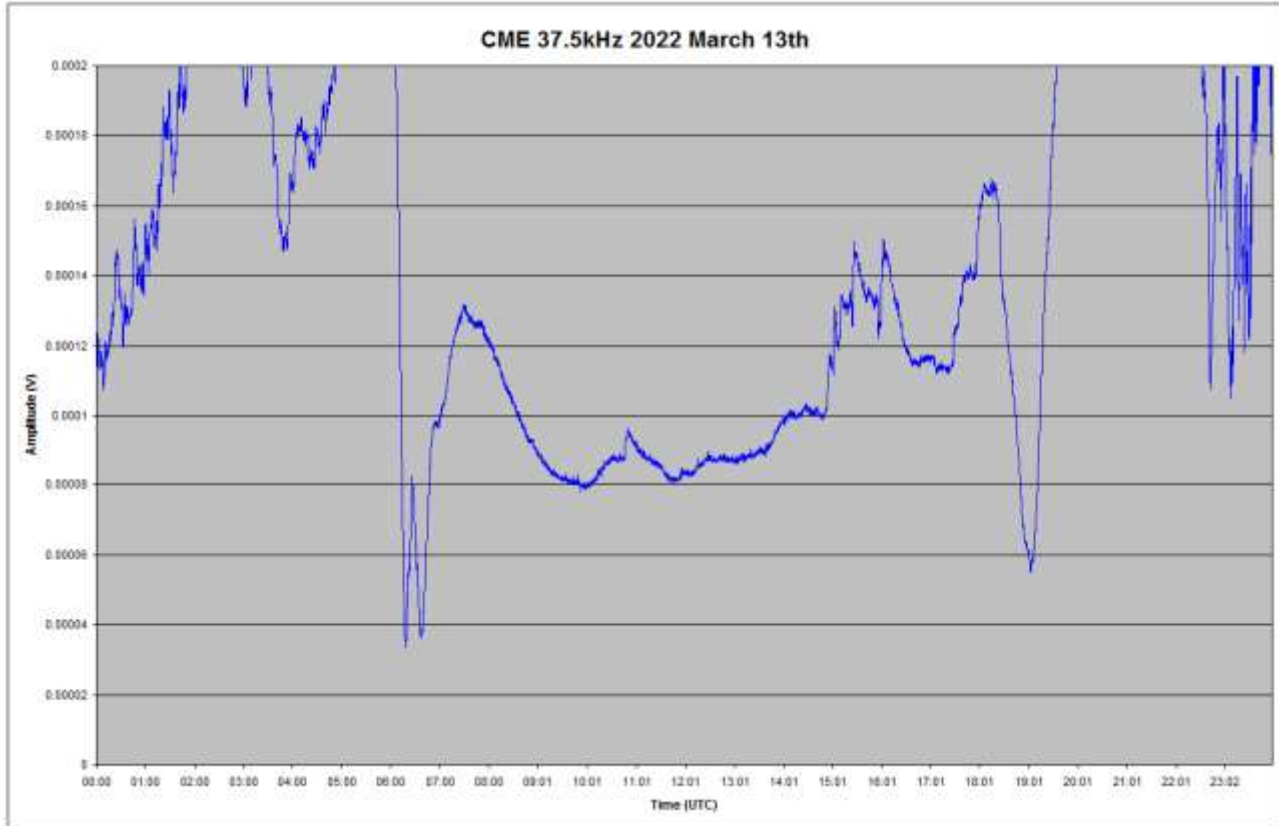

Mark Edwards' recording of the 37.5kHz signal from Iceland also shows some disturbance after 15UT as well as a sharp transient just before 11UT matching the magnetic disturbances.

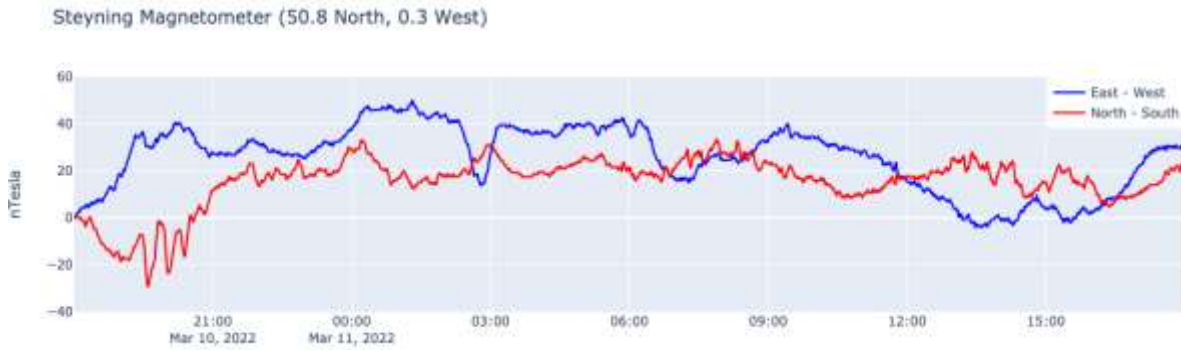

Steyning Magnetometer (50.8 North, 0.3 West)

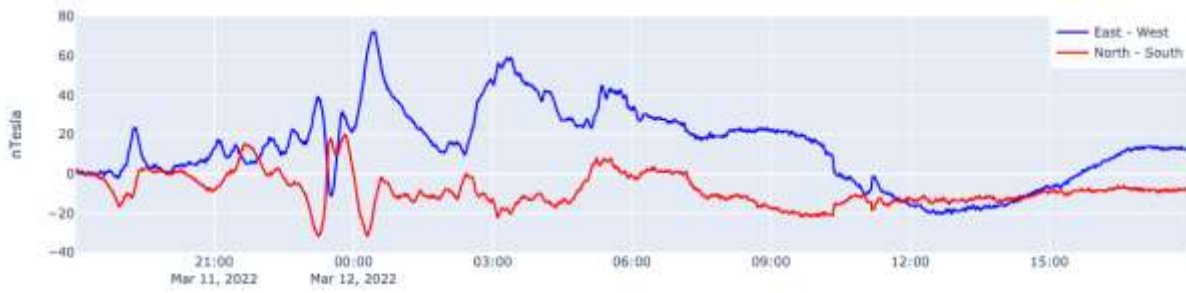

CMEs on the 5<sup>th</sup> and 6<sup>th</sup> were recorded in satellite data, arriving late on the 10<sup>th</sup>. These recordings by Nick Quinn show the disturbances through the 11<sup>th</sup> and the morning of the 12<sup>th</sup>. No CME impact transients were recorded.

There were also some coronal hole high speed winds present, notably on the 5<sup>th</sup> and 6<sup>th</sup>, shown in the recording by Colin Clements:

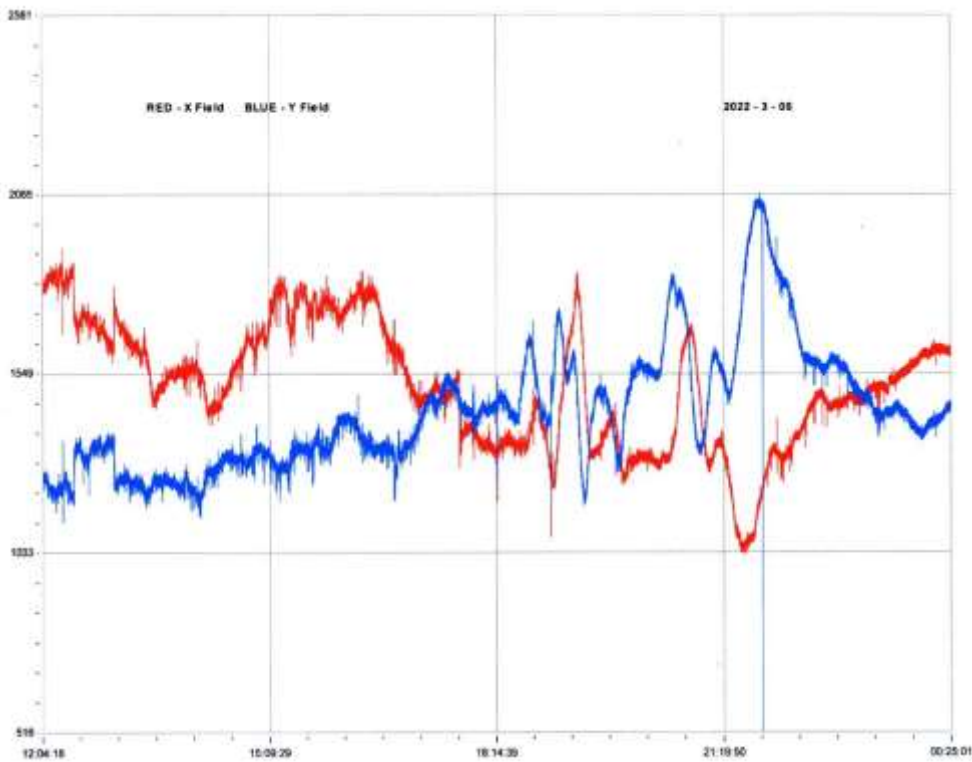

Bredons Hardwick Magnetometer (52.02N,2.13W)

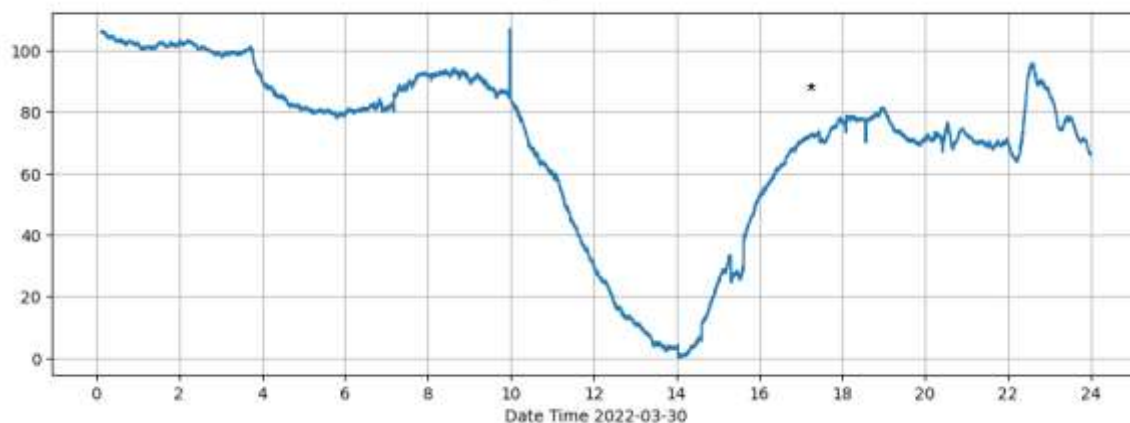

This recording by Callum Potter may well show a small SFE from the X1.3 flare peaking at 17:30 on the 30<sup>th</sup> marked ‘\*’ on the chart. A similar small transient is also visible on Roger Blackwell’s recording, but without a precise overlay of the X-ray data it is difficult to be certain. The spike at 10UT appears to be from local interference. There had also been some disturbances from a number of CMEs before this flare, with another stronger CME arriving early in the morning of the 31<sup>st</sup>, shown in the recording by Paul Hearn on the next page. The transient seen at about 03:30 may well be the CME impact, the disturbance then increasing through the afternoon and fading out by midnight.

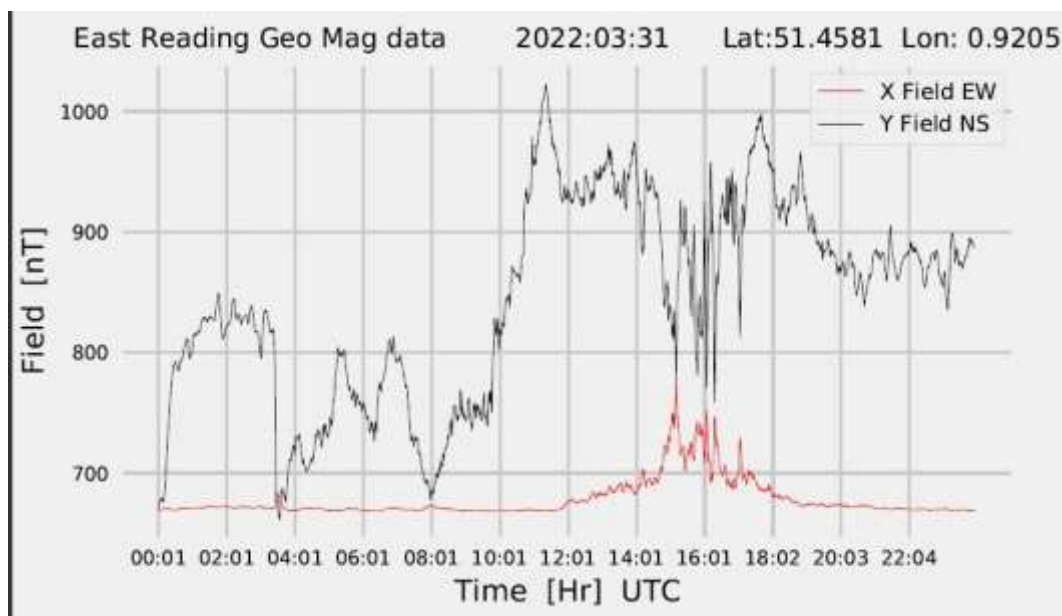

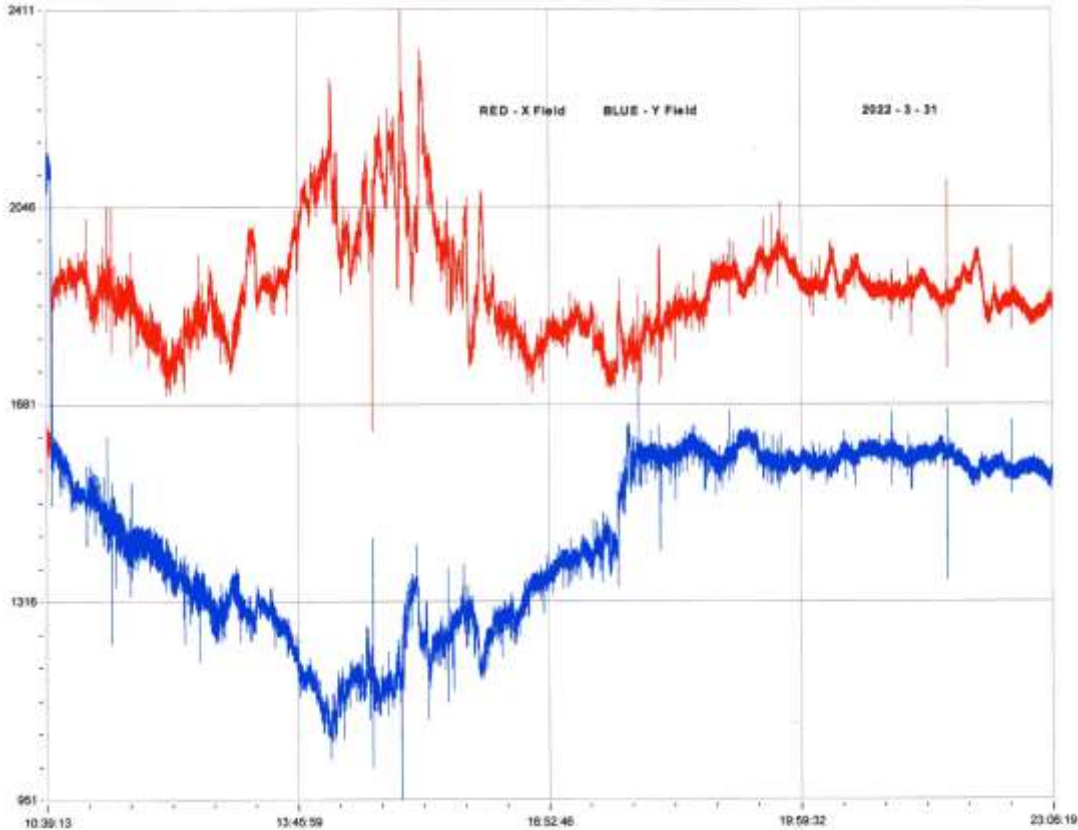

The disturbance during the afternoon can also be seen in this recording by Colin Clements.

Magnetic observations received from Roger Blackwell, Colin Clements, Stuart Green, Paul Hearn, Callum Potter, Nick Quinn and John Cook.

**RADIO SKY NEWS**

**2022 APRIL**

**VLF SID OBSERVATIONS**

This month has seen the highest level of solar activity so far in cycle 25, with 99 individual flares recorded and 132 SIDs. We are about three years into the cycle, and this count compares well with the 102 flares recorded in 2011 September, three years into solar cycle 24. The day length is increasing rapidly at this time of year, and so the figures may be slightly distorted by the longer recording period available each day. We have also gained more observers over the years, along with more experience in analysing the recordings. April ended with ‘a bang’, with an X1.1 flare well timed in mid-afternoon.

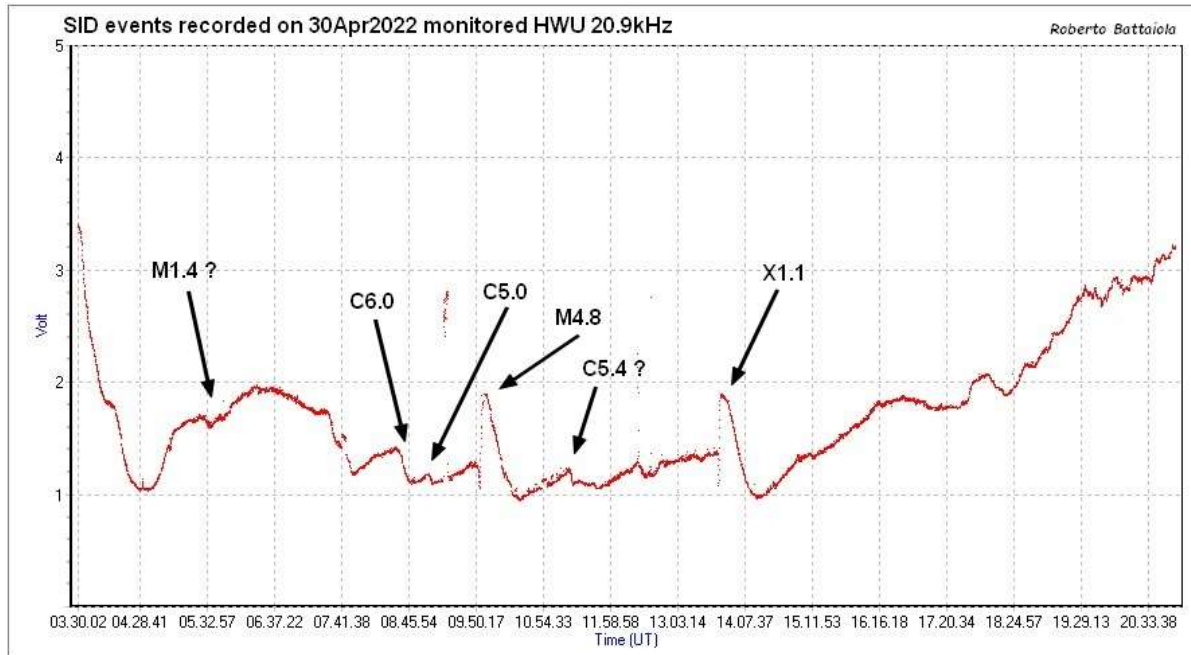

This recording by Roberto Battaiola in Milan shows the X1.1 flare, along with the rest of the day's activity. Both the X1.1 and M4.8 flares have produced clean 'spike and wave' SIDs, while the smaller flares show as ordinary 'shark's fins' SIDs. There is also a strong noise spike just after the C5.0 flare.

The chart on the next page from Mark Edwards shows the X1.1 SIDs in more detail on 9 frequencies:

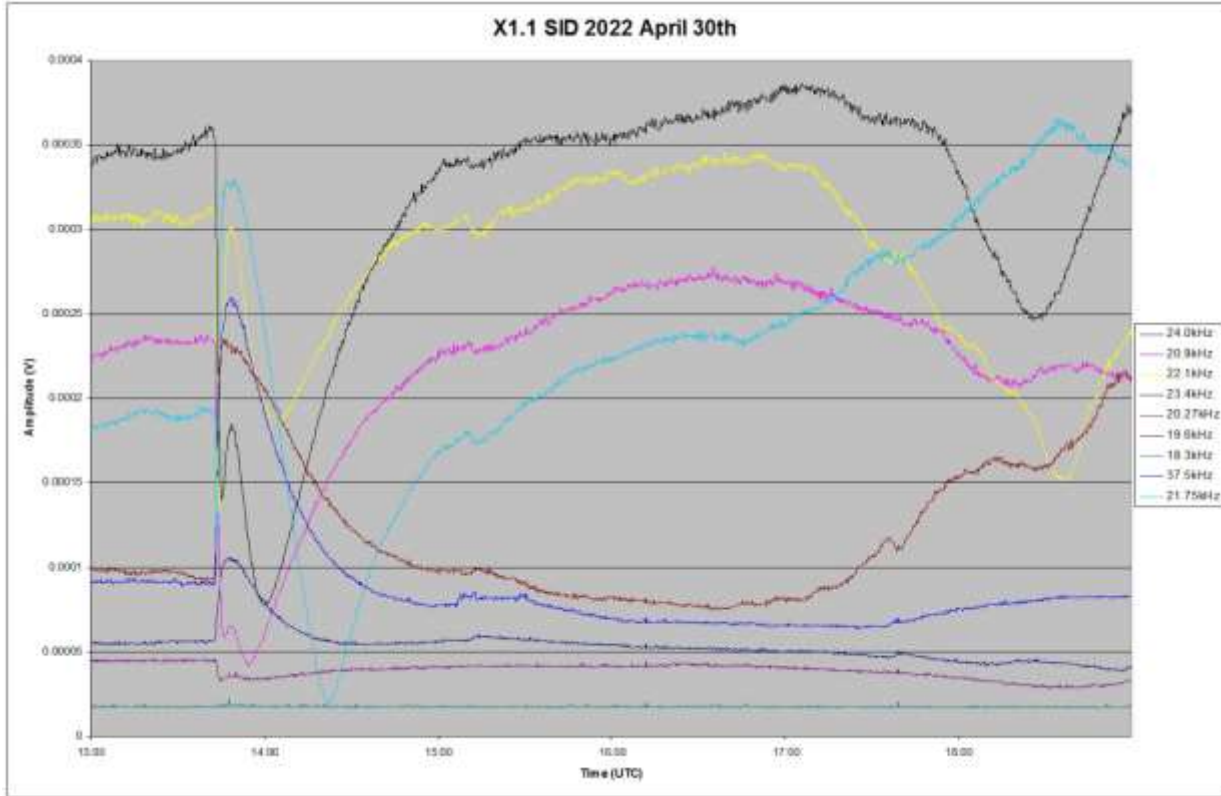

The very rapid rise of the flare is clear on all of the signals, with the peak timings all within a minute of each other. 18.3kHz appears to have been off at the time, while the longer distance paths at 24kHz and 37.5kHz show simple 'shark's fin' SIDs. A small secondary peak is also visible around 15:15UT on most of the signals. The shape of the recorded SID varies with the observer's location. Paul Hyde (Basingstoke) recorded a mixture at different frequencies, while Colin Clements (Lisburn) and Phil Rourke (Broughty Ferry) recorded just 'shark's fins', as did Mark Prescott (Kent) shown in this recording:

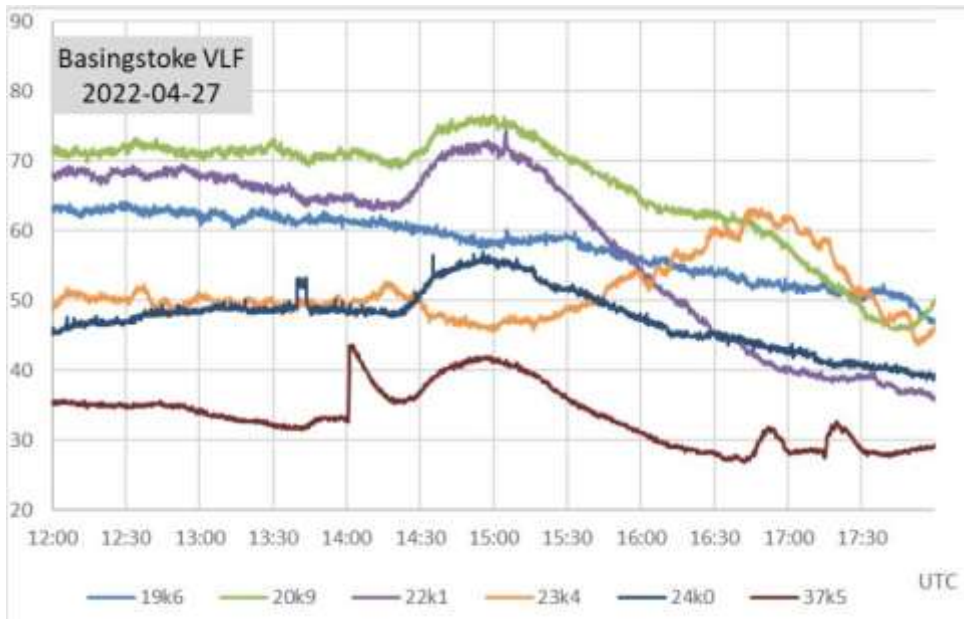
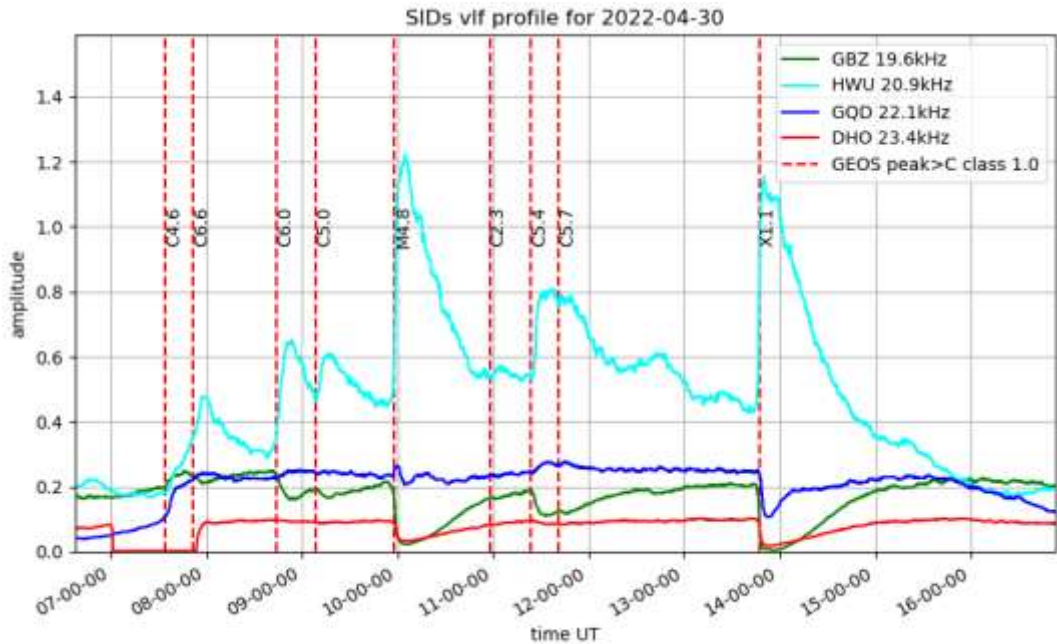

In contrast to the rapid X1.1 flare, the C7.6 flare on the 27<sup>th</sup> was extremely slow, producing a Slow Ionospheric Disturbance. The above recording by Paul Hyde shows the result. The 37.5kHz signal in particular is very misleading, with magnetically induced pulse at 14:00UT, masking the start of a long ‘bump’ in place of a normal SID. 23.4kHz shows an inverted response, helping to identify the SID. The X-ray data shown in the SWPC bulletin lists a start time of 14:14, a peak at 14:54, and an end time of 01:27UT the following day. I think that our own timings are very consistent, given that X-ray data.

April 15<sup>th</sup> also produced a multiple flare lasting for most of the day. Mark Edwards has added the satellite X-ray data to his 24kHz signal in this chart:



The SWPC lists just two M-class flares (as included in our timing tables), but this clearly shows extra peaks between them. Mark Prescott has a similar response at 20.9kHz:

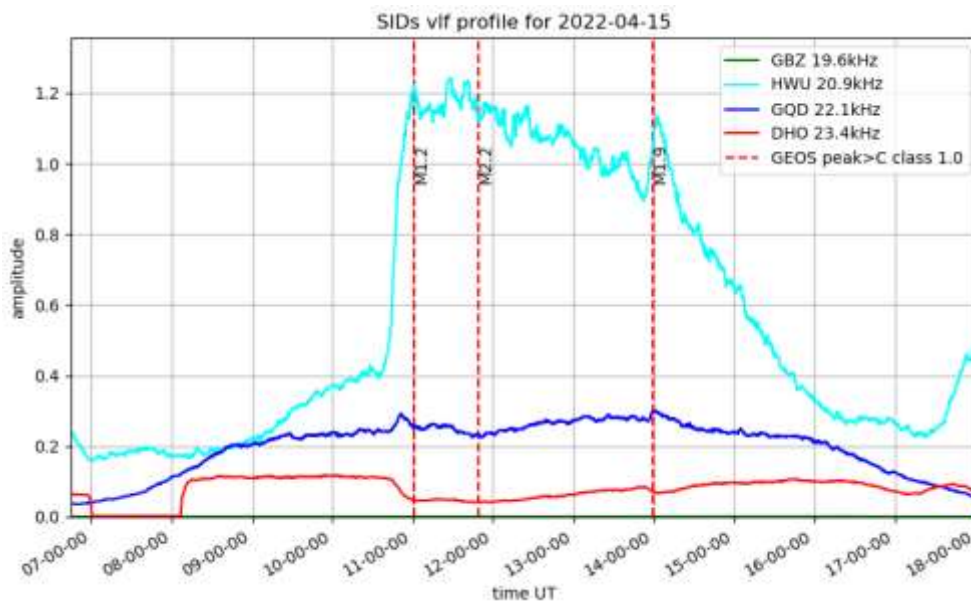

The 20.9kHz path length would be much shorter (~340km) compared to the Trans-Atlantic 24kHz path, so a surprisingly similar response. Roberto Battaiola also monitored 20.9kHz, with a rather weaker response:



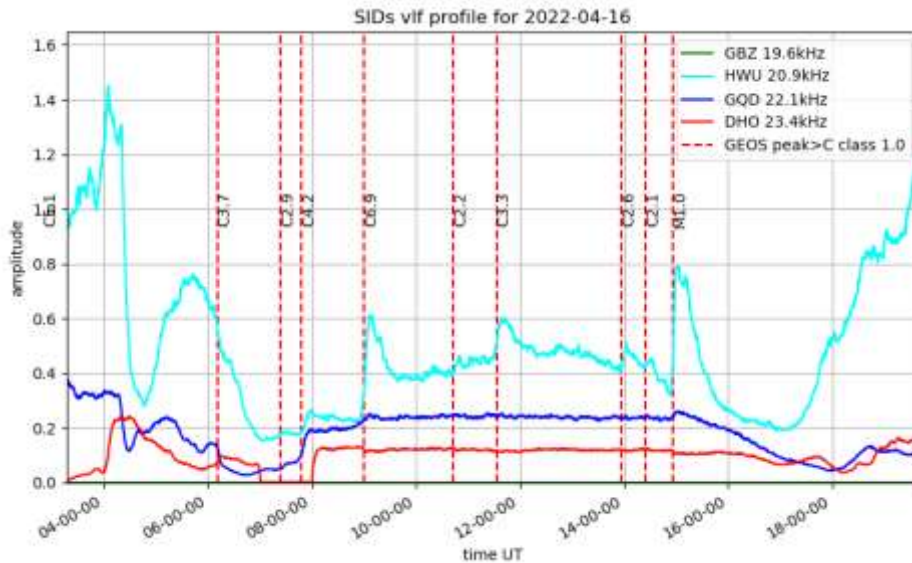
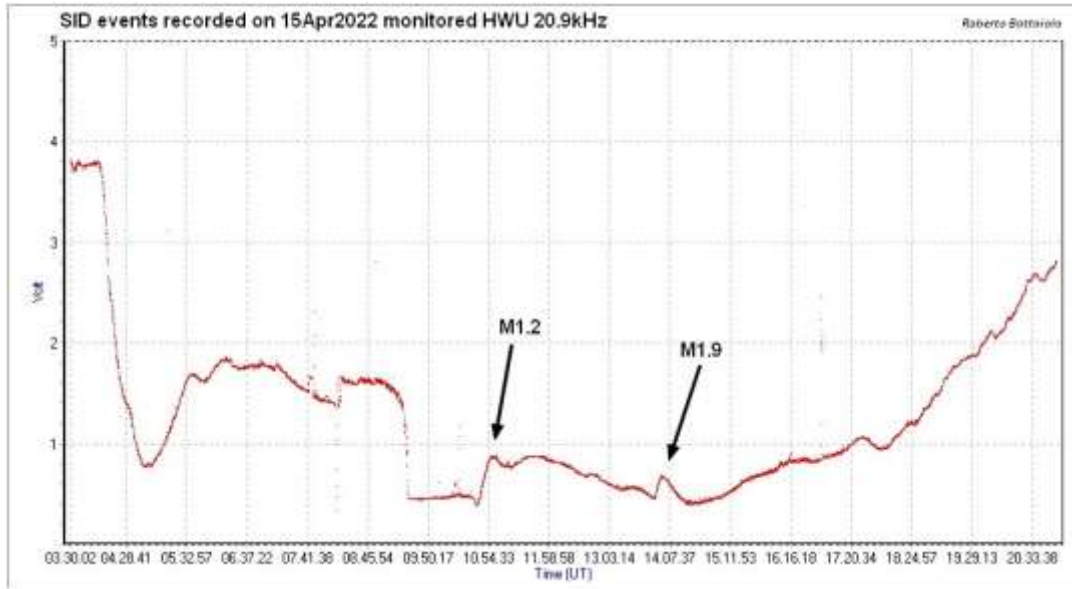

There was a total 15 SIDs recorded on the 16<sup>th</sup>, the nine listed flares being identified in the above recording by Mark Prescott. Just two events were recorded on the 6<sup>th</sup>, but Mark Edwards' recording shows an oscillation at 37.5kHz following the C3.1 flare at 11:30UT. There does not appear to be any CME or magnetic connection.



**MAGNETIC OBSERVATIONS**

Stuart Green has unfortunately had to shut down his magnetometer due to building work, so there is no month’s summary chart for April. Paul Hyde’s 37.5kHz signal from the 27<sup>th</sup> showed a magnetically induced pulse at 14:00UT. This magnetic recording by Nick Quinn shows the disturbance responsible:

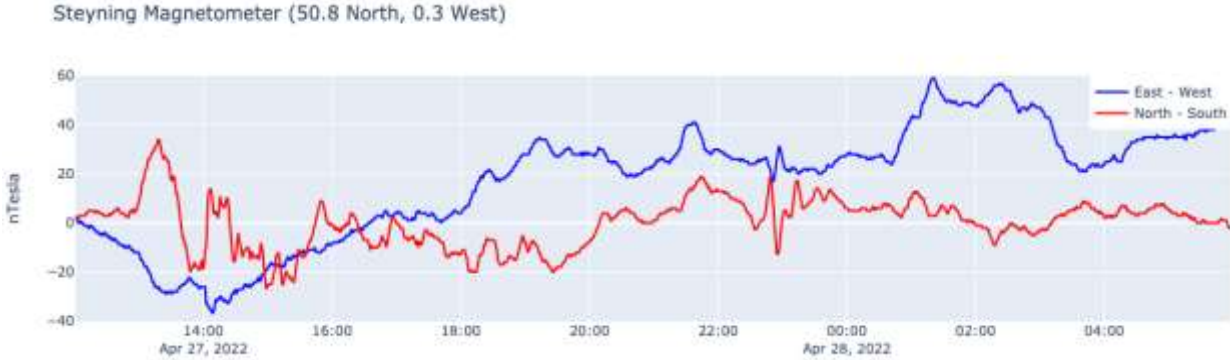

The source of this disturbance seems to have been a high speed wind. Despite the large number of flares recorded, there were very few Earth-directed CMEs shown in satellite images. A filament eruption on the 7<sup>th</sup> produced a small CME resulting in some magnetic disturbance on the 9<sup>th</sup> and 10<sup>th</sup>. The recording by Roger Blackwell on the next page shows a very active period between 03 and 06UT on the 10<sup>th</sup>. There was also a high speed wind present at the same time.



Bredons Hardwick Magnetometer (52.02N, 2.13W)

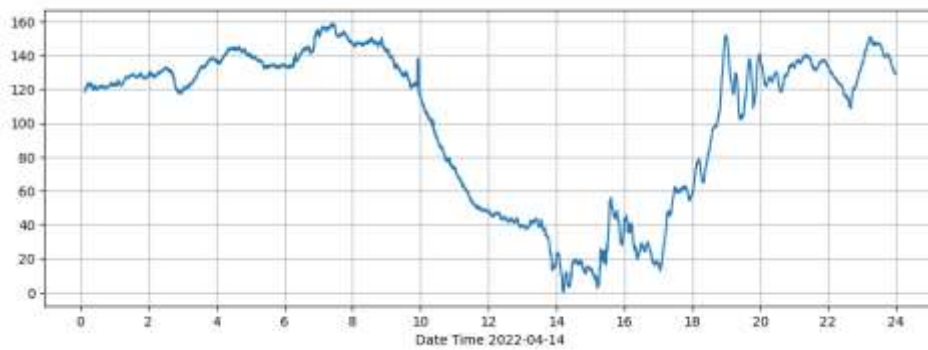

A C1.6 flare at 05:12UT on the 11<sup>th</sup> did produce a fairly slow CME, arriving in the morning of the 14<sup>th</sup>. The disturbance later in the afternoon is shown in the recording above by Callum Potter, and through into the 15<sup>th</sup> by Nick Quinn, below.

Steyning Magnetometer (50.8 North, 0.3 West)

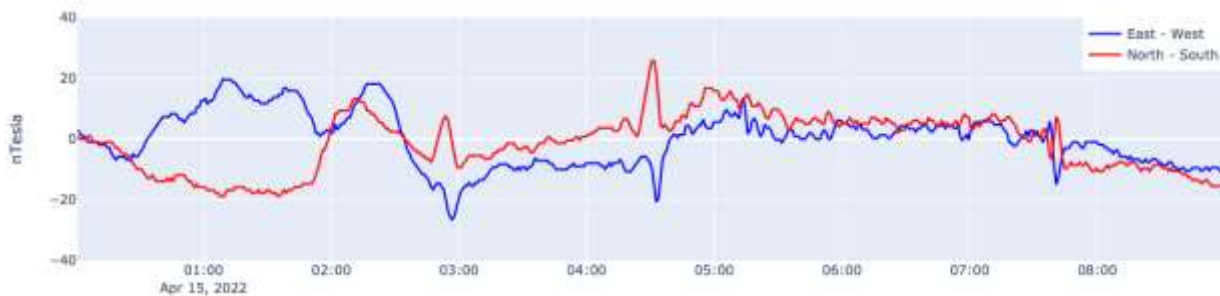

The active region responsible for the X1.1 flare peaking at 13:45 on the 30<sup>th</sup> (AR12994) was right on the western solar limb, and although satellite images show a CME, it was not Earth directed. There is a possible SFE shown in my own recording, and also in the recording by Callum Potter:

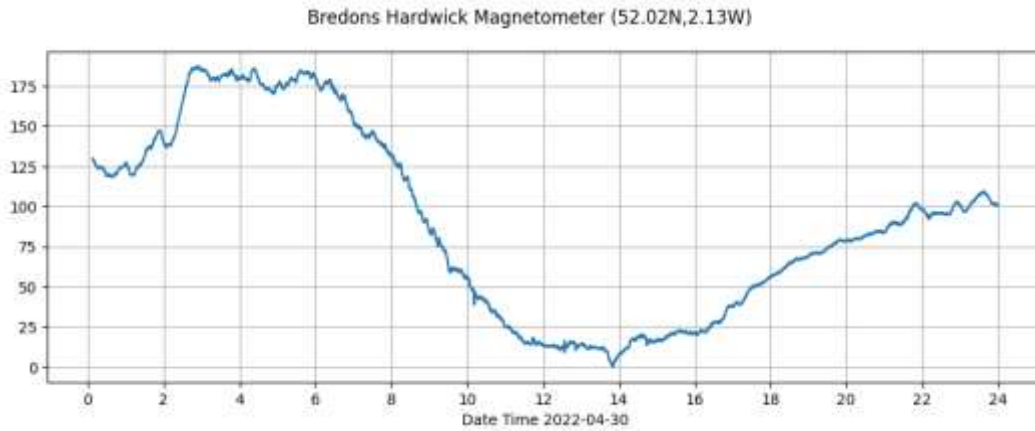

Magnetic observations received from Roger Blackwell, Colin Clements, Paul Hearn, Callum Potter, Nick Quinn and John Cook.

### SOLAR EMISSIONS

The strong activity on the 30<sup>th</sup> was accompanied by radio noise bursts detected across the spectrum. Colin Clements recorded this activity at VHF:

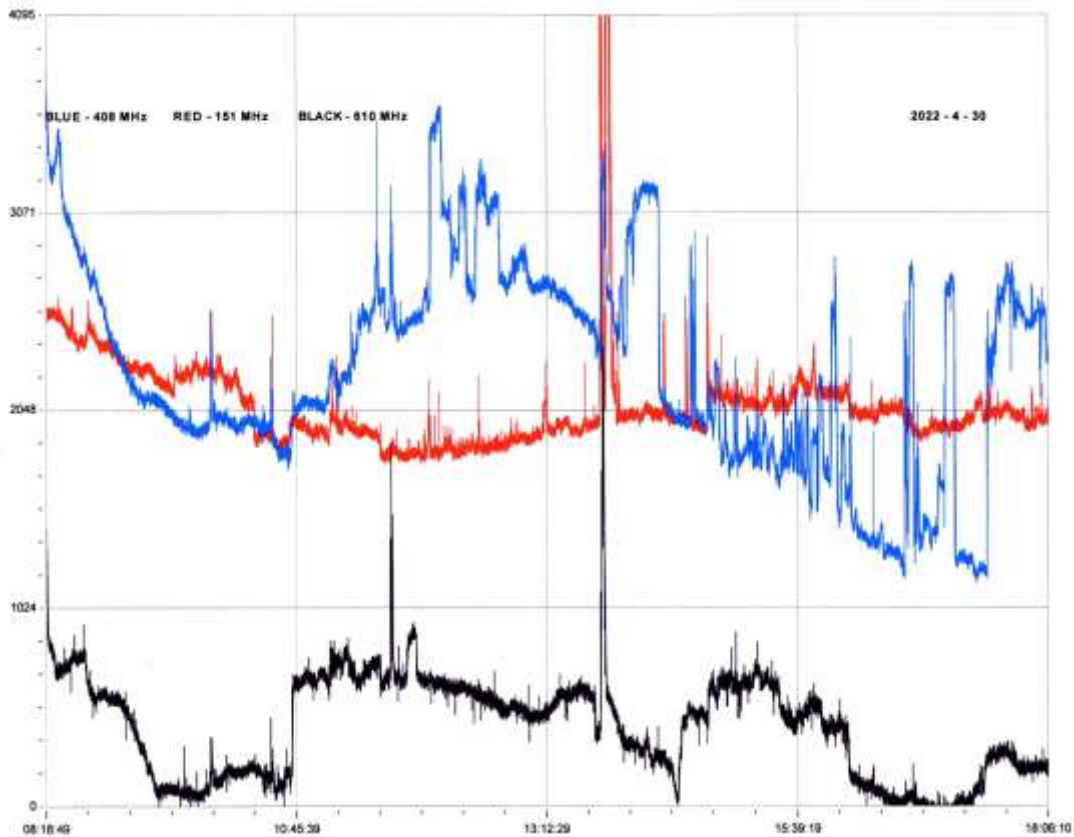

The strong spike around 13:30 is possibly linked to the X1.1 flare. Colin Briden made observations at 28MHz:

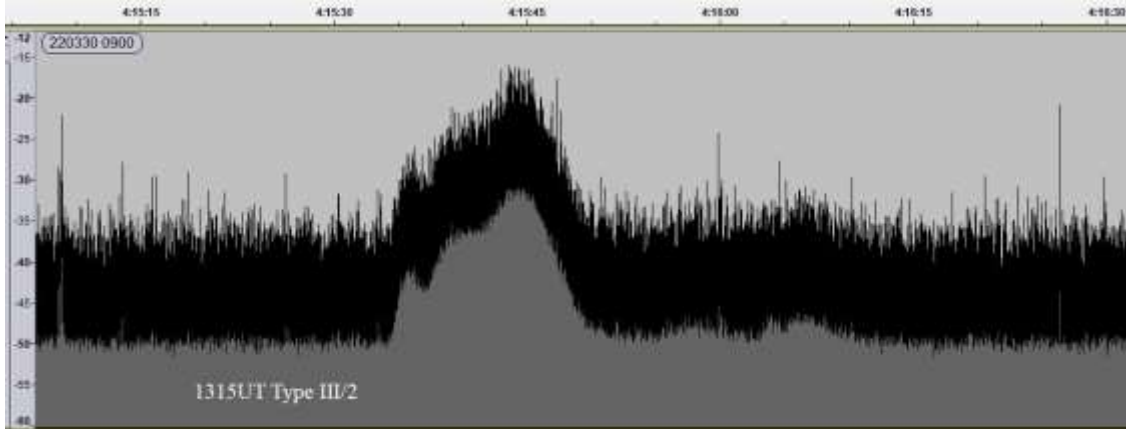

This shows a rise of about 30dB lasting just over 20 seconds, very powerful compared to previous bursts. He also made an audio recording of the event, available if anyone is interested. A much weaker 28MHz burst was recorded on the 27<sup>th</sup>. The two peaks shown on Colin Briden’s recording are only about 15-20dB, but the timing matches well with the smaller C2 flare shown in our SID list. In these charts, the grey area represents the averaged data, while the black area shows individual data peaks.

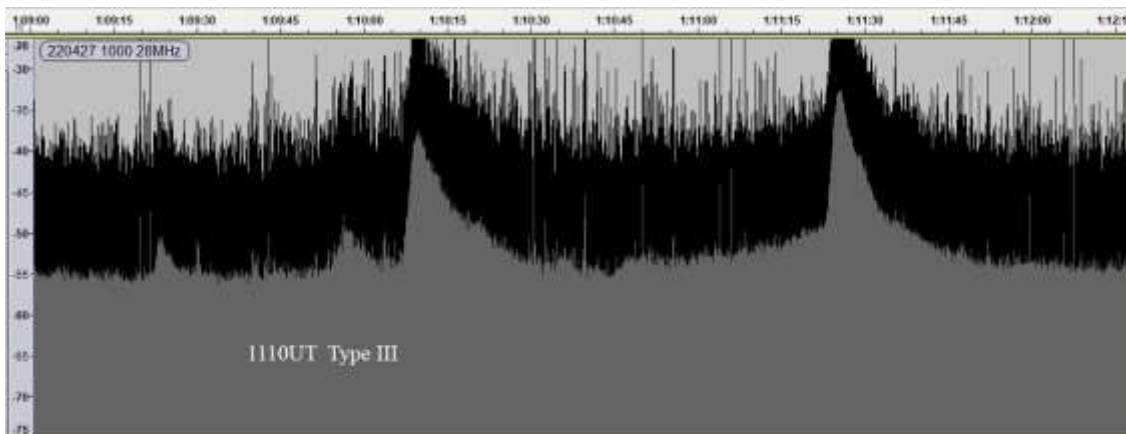

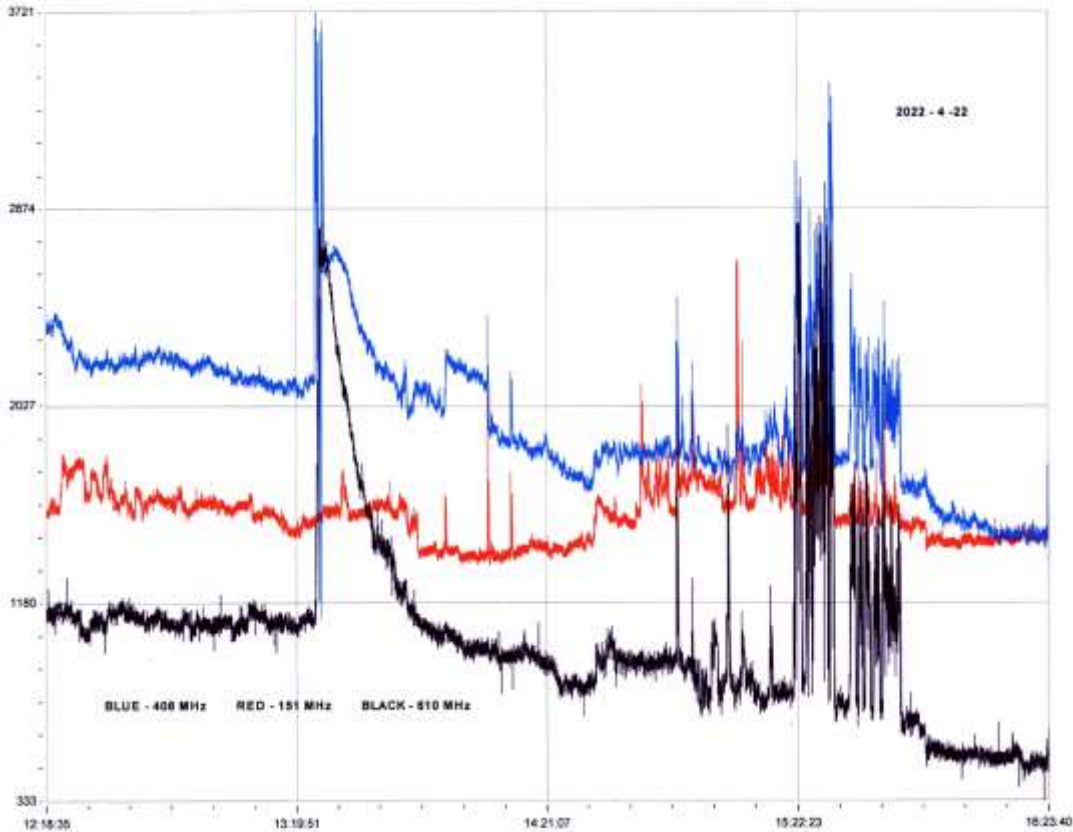

This recording by Colin Clements shows VHF activity on the 22<sup>nd</sup>. The M3.4 flare peaking about 13:30UT produced a very strong and distinct noise burst at 408MHz (blue) and 610MHz (black), with a smaller burst at 408MHz (red). All three frequencies also show a very noisy period from about 14:50 to 15:50. This includes the C2.0 flare at about 15:10, but the X-ray satellite data was fairly flat otherwise.

The chart on the next page shows the 37.5kHz signal along with the three VHF frequencies recorded by Colin Clements on the 23<sup>rd</sup>. The chart covers 07:35 to 17:00UT. It shows what appears to be a very strong SID at 37.5kHz, starting at 10:17 and lasting until 14:06. This is accompanied by a gentle rise and fall at 610MHz and a stronger emission at 408MHz. There is no evidence of a flare in the X-ray data at this time, and none of our observations show any significant magnetic activity. An interesting and rather puzzling observation.

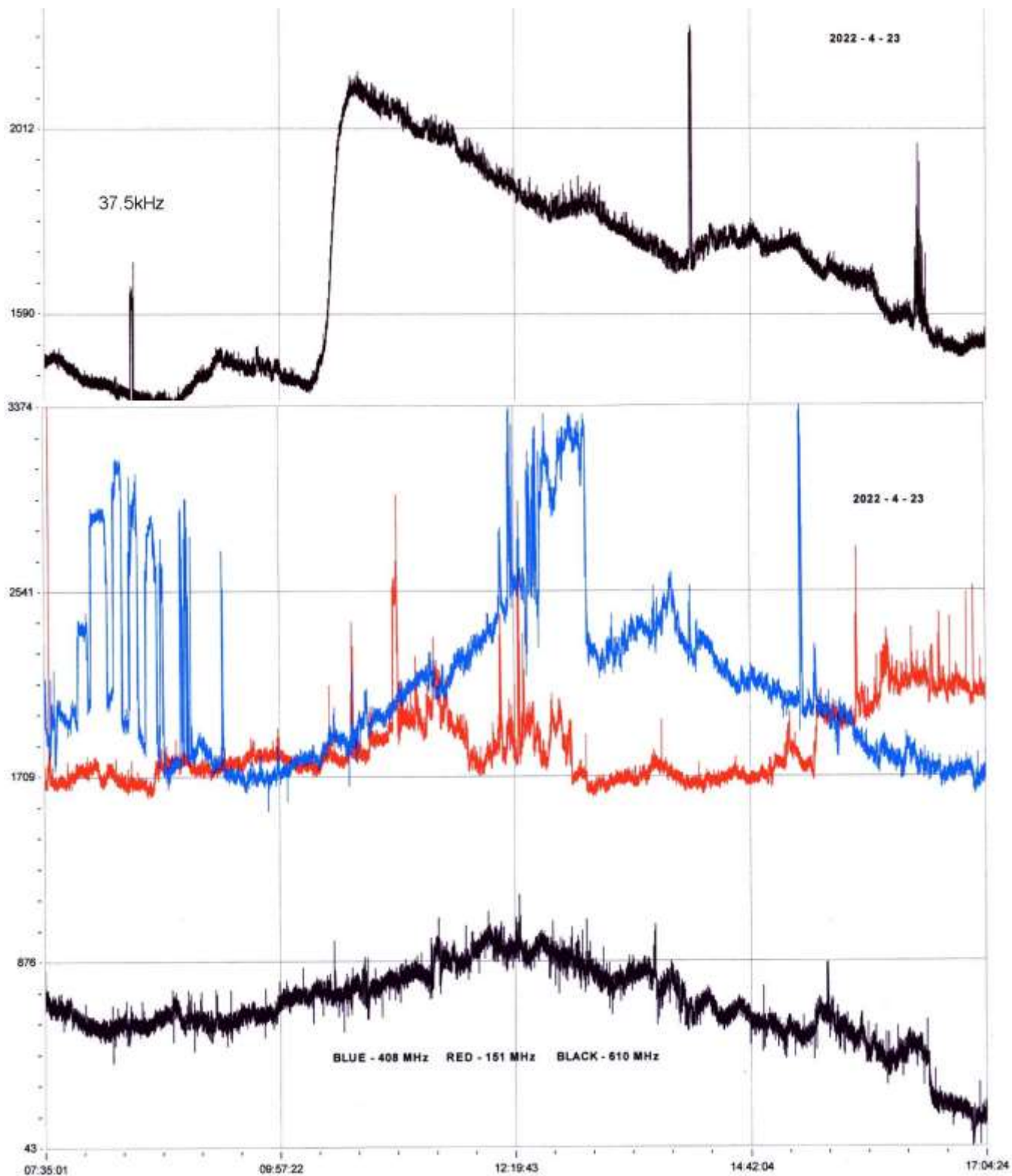

# BARTELS CHART

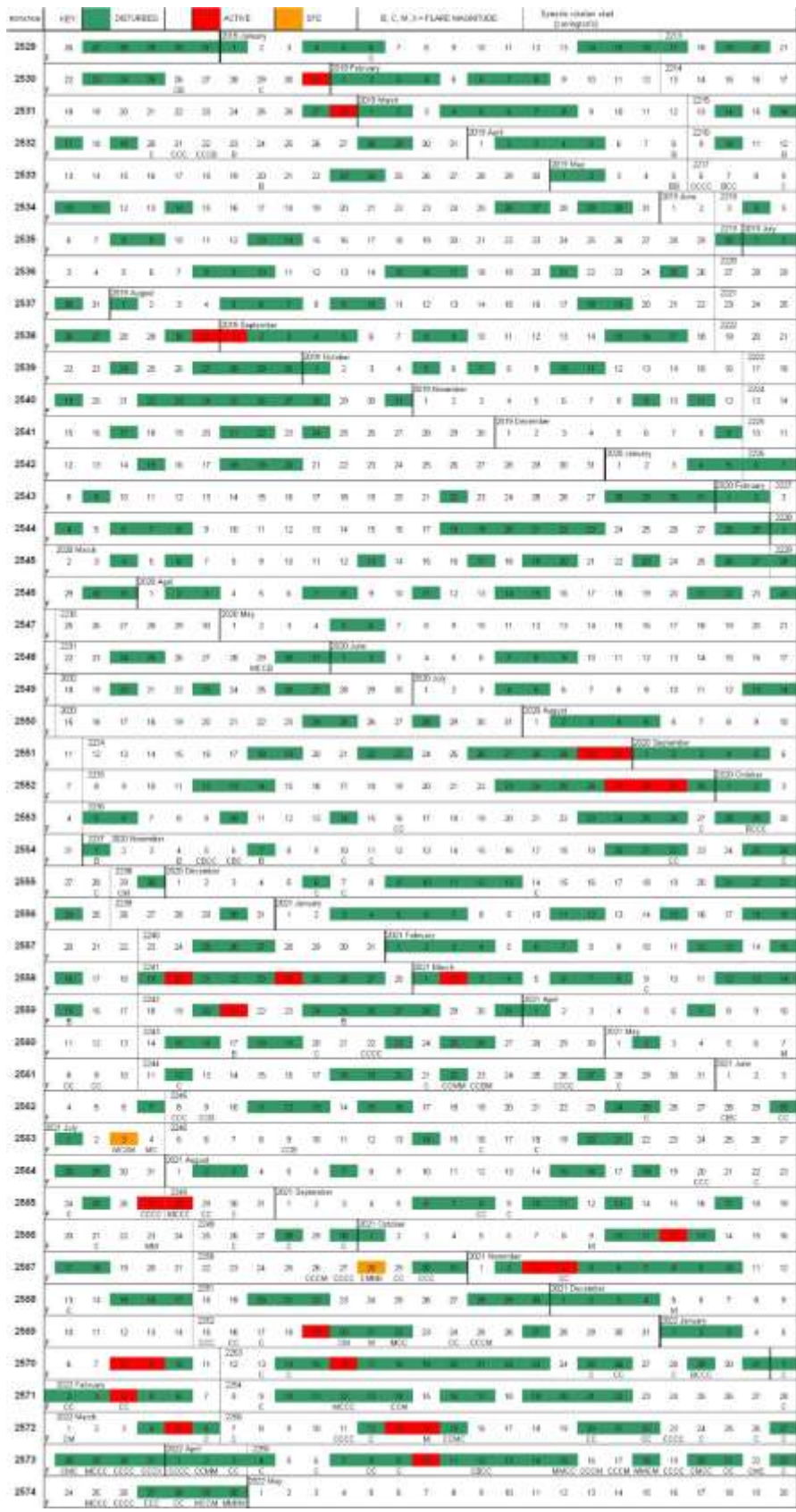



### VLF flare activity 2005/22

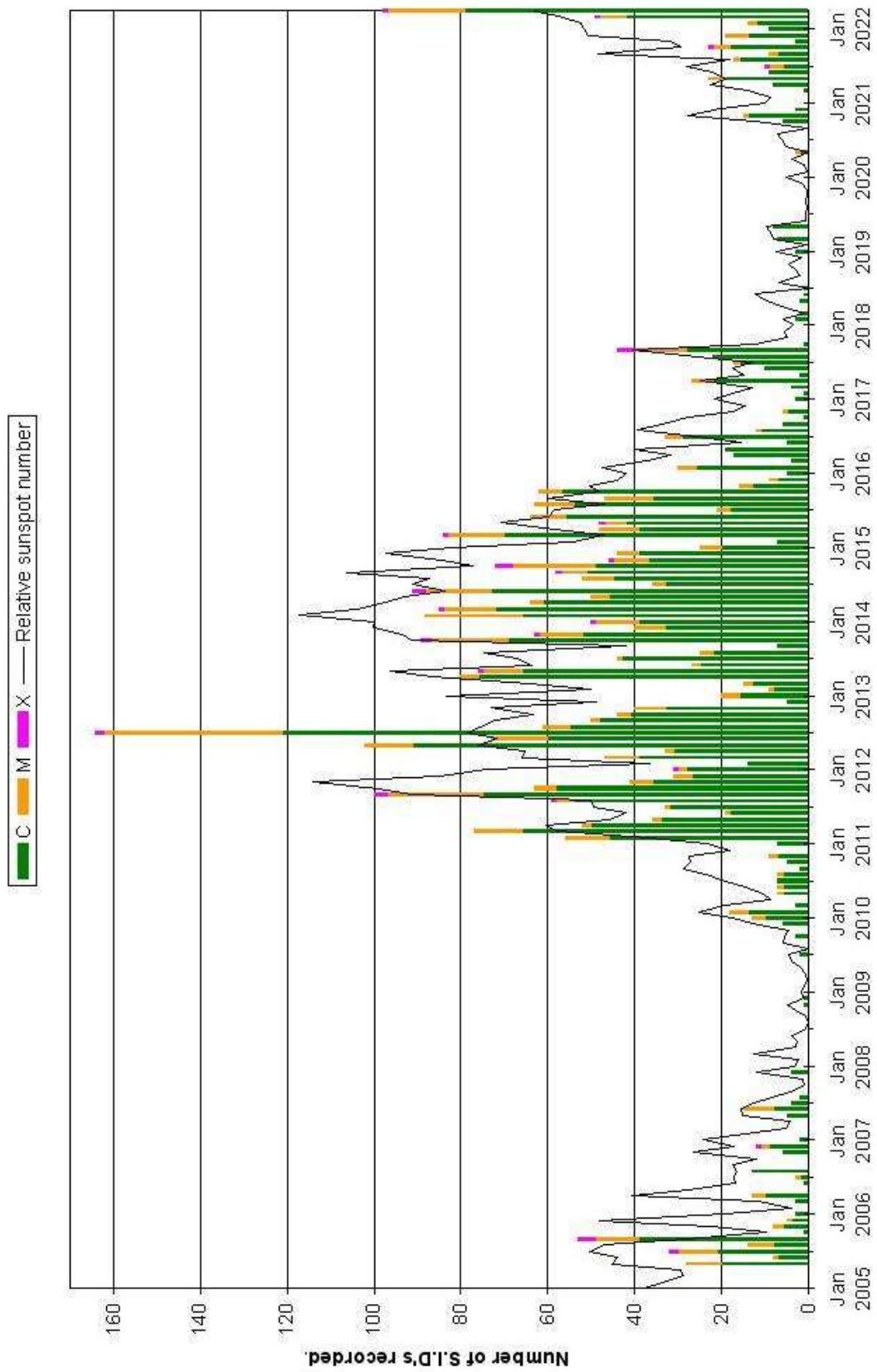



## BAA RA Section Autumn programme 2022

<b>July 1<sup>st</sup>.</b> 19:30 BST (18:30 UTC)	<b>Prof. Jim Madsen</b>  Executive Director Wisconsin IceCube Particle Astrophysics Centre. (WIPAC)	<i>'Cosmic neutrinos – messengers from the cosmos arriving in Antarctica'.</i>
<b>Sep. 2<sup>nd</sup>.</b>  19:30 BST (18:30 UTC)	<b>Dr Helen Russell</b>  School of Physics & Astronomy Nottingham University	<i>x-ray astronomy</i>  'An X-ray view of the Universe
<b>Oct. 7<sup>rd</sup>.</b>  19:30 BST (18:30 UTC)	<b>Dr Samuel Lander</b>  Theoretical astrophysicist. Univ. East Angela. The main focus of research is neutron stars: the collapsed remnants of a normal star's core following a supernova.	<i>All about Magnetar's</i>  A magnetar is a type of neutron star with a particularly strong magnetic field. This field powers a range of outburst activity, from X-ray and gamma- ray bursts and flares, to the recently discovered fast radio bursts. This talk will survey the observations and give a picture of how a magnetar releases all this energy.
<b>Nov. 4<sup>st</sup>.</b>  19:30 GMT (18:30 UTC)	<b>Prof. John Richer</b>  The Cavendish Laboratory Cambridge Univ.  John Richer is an astrophysicist with expertise in the field of star formation, with a particular in interest in radio and submillimetre observations of young stars and protostellar systems.	<i>'On ALMA'</i>  Atacama Large Millimetre/submillimetre Array  ALMA is a submillimetre interferometer at the Chajnantor site in the Atacama Desert at 5100 metres above sea level.  The principle research areas are millimetre and submillimetre imaging and spectroscopic observations of star-forming regions in our own Galaxy, in nearby galaxies, and in the very distant universe. These observations provide an unobscured view of the cold universe.

Dec. 2<sup>st</sup>.

**Dr. Emma Chapman**

**Christmas Lecture**

19:30 GMT (18:30 UTC)

Guest star: JWST

*'Exploring the Dark Ages of the Universe by Radio'*

Royal Society Dorothy Hodgkin fellow  
based at the University of Nottingham.

The first stars ever! 400 million years after the big bang. This era has never been observed and constitutes over a billion-year gap in our knowledge.

If you have any suggestions for the winter 2023 term do let me know.

Our meetings are open to all. Once you are registered on the RA Section email list the Zoom link will be sent out to you before the meeting. If you are not on the email list, please request registration from Paul Hearn ( [paul@hearn.org.uk](mailto:paul@hearn.org.uk) ).

All recordings will be posted on our BAA YouTube channel. <https://www.youtube.com/user/britishastronomical/playlists>

## Development of a Telescope Tracking System - Part 3

### Jack H. Lobinger

#### Introduction

This article is the third and final in a Series of articles describing the development of a Real Time Position Control and Tracking (RTPCT) application for my three-meter antenna. This part of the Series will deal with the application itself, along with the client/server based sub-applications. The system is designed around network based control of the various applications and their interaction with the control RTPCT GUI application, written in Python3 and PyQt5.

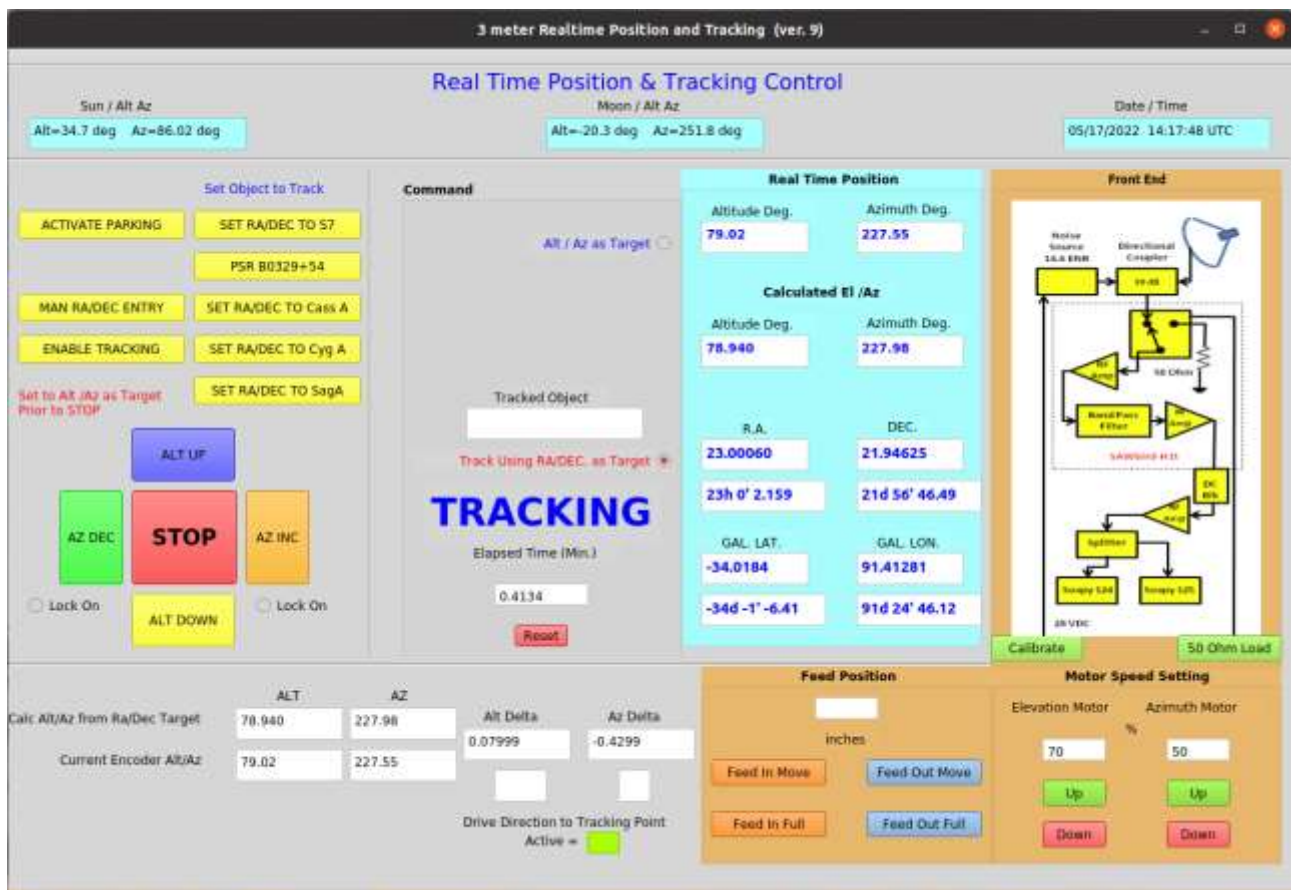

Figure 1: Real Time Position Control and Tracking GUI

Figure 1 represents a screen capture of the RTPCT GUI during an active tracking run. While most of the functionality is dedicated to positioning and tracking there are a number of other functions that allow either control of auxillary functions or provide feedback on system operation. These functions are server based at the antenna and are network connected to client functionality in the RTPCT GUI. The following sections will provide an architecture and detailed description of those functions.

## Server Based Architecture

Block Diagram At Antenna

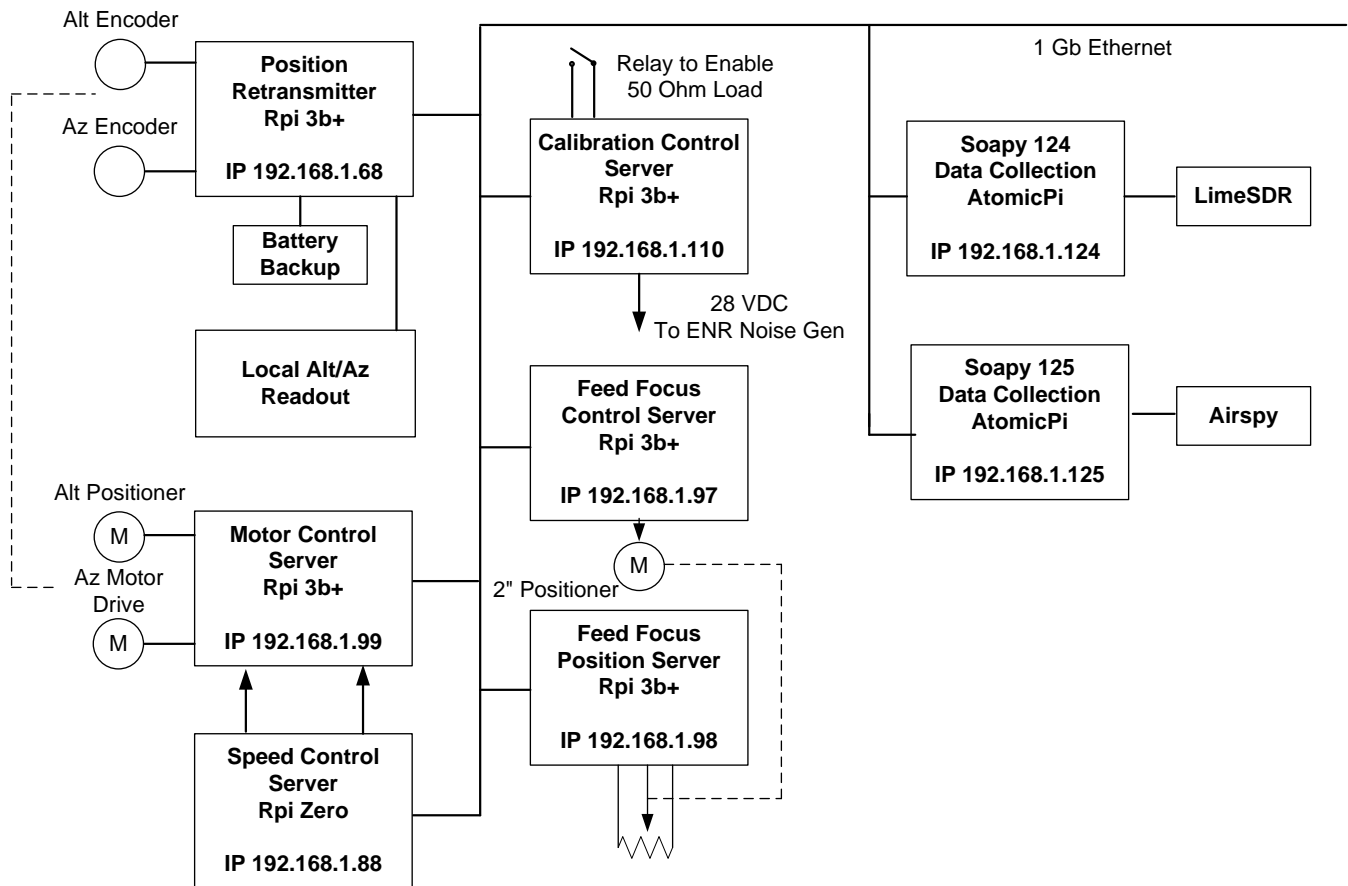

Figure 2: Server Architecture Located at the Antenna

As you will notice there is a strong reliance on the use of Single Board Computers (SBCs) to provide the functionality needed for these applications. They are ideal for providing the single function applications needed, they are inexpensive, and they are easy to program and use. However, they must be implemented in a way that does not flood the area with RFI or detract from the sensitivity of the receiver chain. As I have mentioned in the previous articles of this Series[1] they are all in sealed metal enclosures with ferrites on all lines. In addition, all network cables are of the shielded variety. Scanning the completed box with a Spectrum Analyzer and small probe is very useful in tracking down any leaked signals. I am sure that combining the above functions into a smaller number of SBCs would be a good thing to do, however, in my case the functions were added over a considerable time period as I thought of new functions to add.

All of these server SBCs are network connected, and they are communicated with by VNC. In my case I use RealVNC[5] for both server and client. This allows for the maintenance and operation of these remote units. Most of the SBCs are Raspberry Pi 3b+ units[2], however, Raspberry Pi Zero[3] and AtomicPi[4] SBCs are used as well. Please refer to the first two articles in this Series[1] for details on the positioning and motor drive/speed control functions shown in Figure 2 above. In addition to the functionality at the antenna there is the RTPCT GUI application along with position and data visualization functionality located inside my house. These remote and

local network segments are connected by a one gigabit fiber optic link. Figure 3, below, diagrams the in-house architecture.

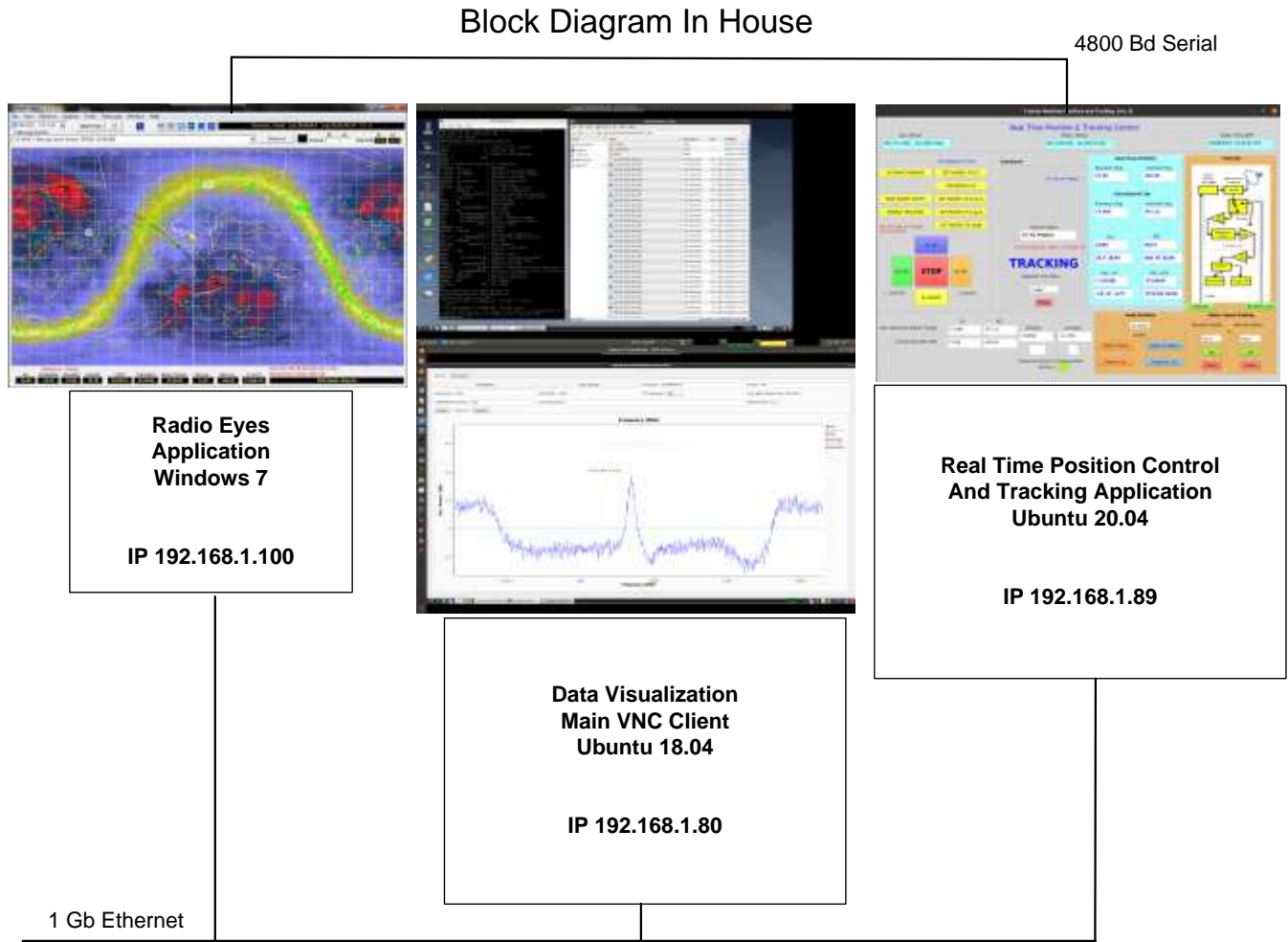

Figure 3: Architecture Located at the House

From the beginning of my interest in Radio Astronomy, I have wanted to build a system that allowed remote operation and maintenance. The remote maintenance part is probably a dream, as I am always going out to the dish to do something. However, the software maintenance and operation are quite doable using VNC. Primary operation of the system has the data capture applications running in Soapy 124 and the AtomicPi[4] server, shown in Figure 2. Data files or FITS files are then downloaded to the Ubuntu server in Figure 3 for post-processing. In addition, during normal operation real time data visualization, using the Spectro-Radiometer[6] application, is viewed over VNC on that same Ubuntu server in Figure 3 using VNC. An alternate mode of operation is available since both AtomicPi[4] servers are able to run SoapySDR and Soapy Remote[8] applications. In that case data collection programs, like SDR Spectrometer II Program[7] and Spectro-Radiometer[6], can be run on the Ubuntu server in Figure 3, which is connected by Soapy Remote[8] to real time data from the Soapy 124 and Soapy 125 remote servers in Figure 2.

The remainder of this article will detail the functionality of the RTPCT GUI and the server subsystems shown in Figures 1 and 2.

## Real Time Position Control and Tracking GUI

First, there are two basic modes to the RTPCT GUI application. The first is the Positioning Mode, as shown in Figure 4 below. The functions of this mode are outlined in red.

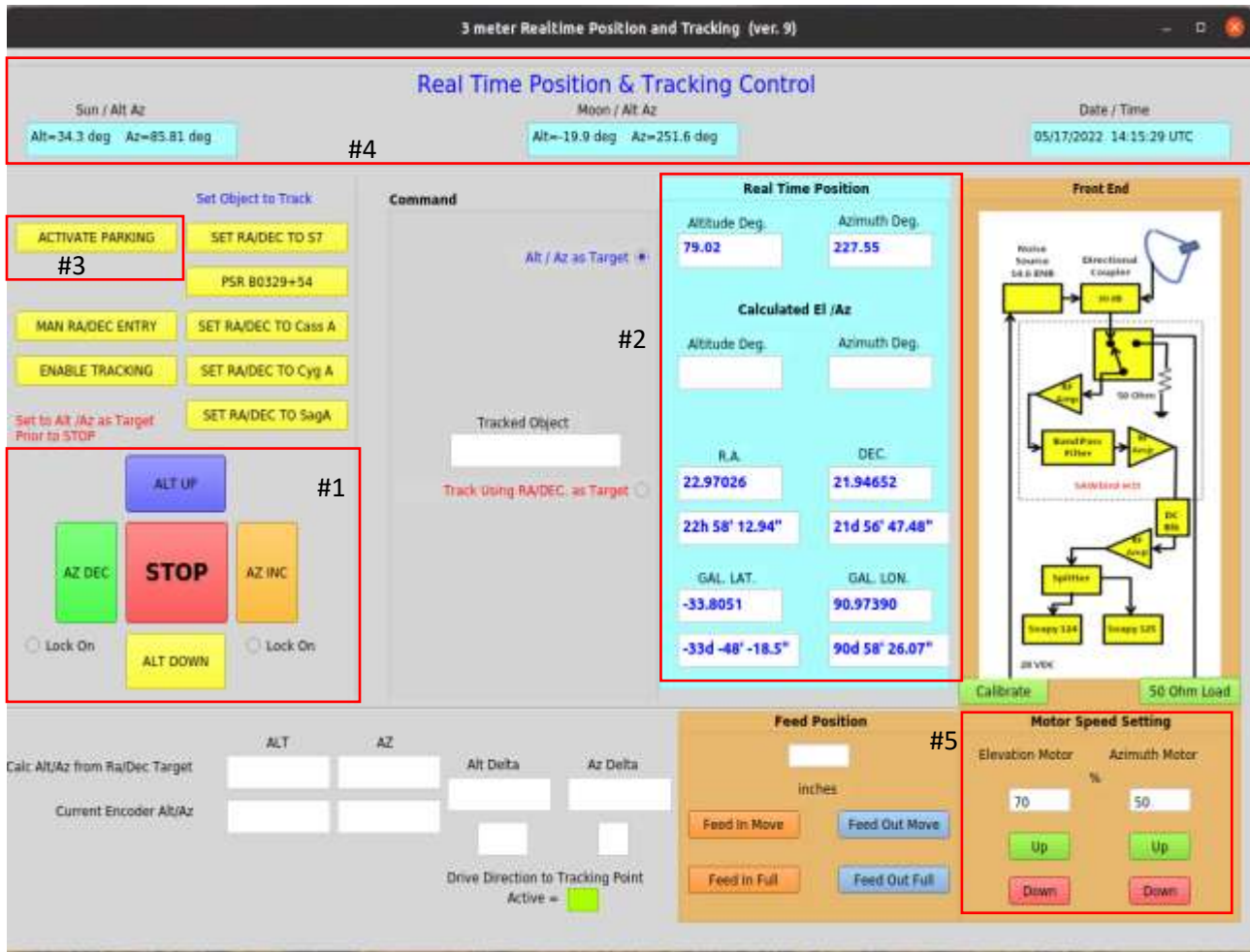

Figure 4: RTPCT GUI Positioning Mode

The function outlined in red, labeled #1, is the manual jog control for altitude and azimuth. The direction of jog is determined by the four labeled buttons. These are momentary, so the axis moves as long as you press the button. For long moves in azimuth, a lock-on check box allows continuous movement until unchecked. This is a good time to talk about safety. As with ANY remote controlled movement device, you MUST HAVE HARDWIRED SAFETY SHUTDOWN SWITCHES installed to prevent over travel. Not doing this guarantees hardware destruction or personal injury, or both at some point. If you use a linear positioner[9] on the altitude axis these two safety switches will be part of the device, otherwise you must put them in your drive. As the axis responds to the drive commands the encoders[10] will feedback the current position, as shown in #2. From the Alt/Az Coordinates the converted RA/Dec and Galactic Coordinates are also displayed. In addition, the calculated Alt/Az Coordinates for the Sun and Moon, as well as the UTC date and time, are also shown in #4. The Alt/Az Coordinates are linked by a 4800 Baud Serial link to the Radio Eyes[11] application server to update the live beam position. Antenna "Parking" can be done by pressing the button in #3. This will raise the altitude of your mount to 90 degrees, or whatever upper limit you set. The motor speed for both axes is adjustable from zero to one hundred percent using the buttons in #5. Figure 5, below, shows the remote servers involved in RTPCT GUI Positioning Mode.

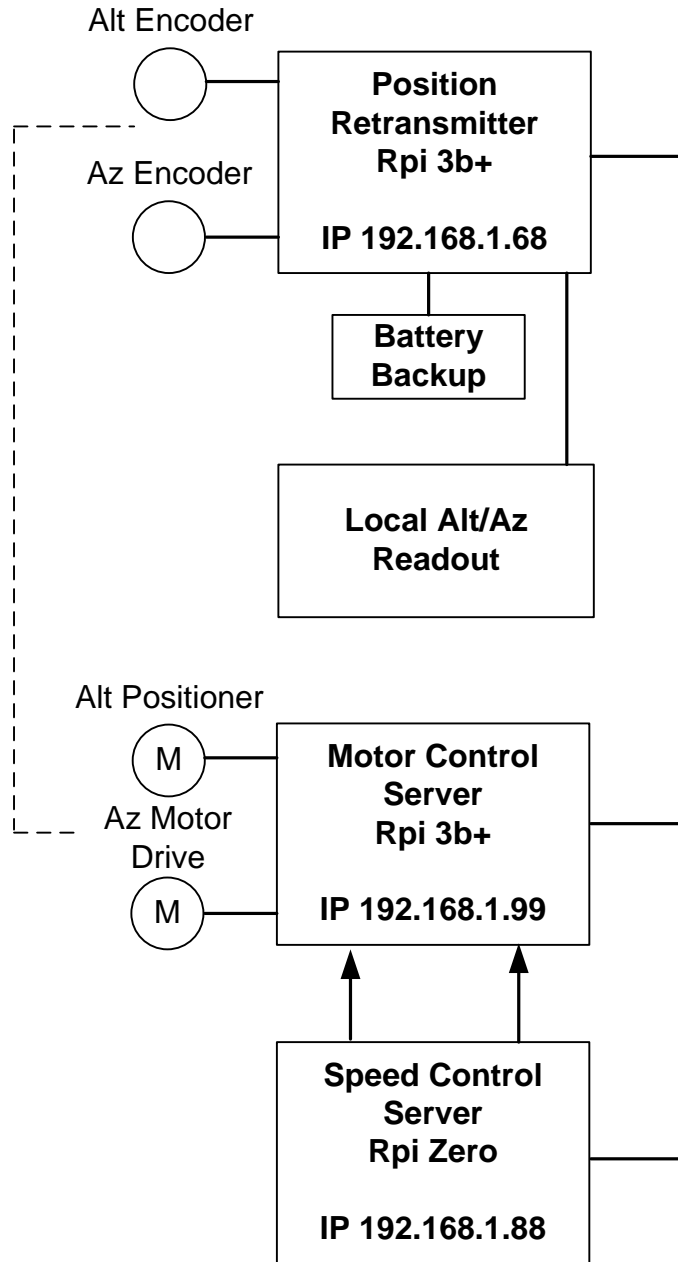

Figure 5: Remote Servers used in RTPCT GUI Positioning and Tracking Modes

The other mode of the RTPCT is the actual Tracking Mode. In this mode the positioners and the motor control form a closed-loop control system. To enter Tracking Mode you click the check box in #3. The target for the tracked position is the value of the RA/Dec Coordinates entered in #2 of Figure 6 below. These may be entered in several ways: They can be the calculated value that is there because of the real time Alt/Az; They can be simply entered into the RA/Dec boxes of #2; or, they can be entered from the stored positions of the objects listed in #5. Any of these will enable tracking by pressing the button in #1. When enabled, the information in #3 will appear unless the requested Alt/Az is below the horizon, in which case “Below Horizon” will replace “Tracking” and tracking will not occur. During tracking the boxes outlined by #4 will contain data on tracking performance. With this current



software, tracking performance is easily within +/- 0.25 degree, and with careful speed control setting +/- 0.1 degree is attainable.

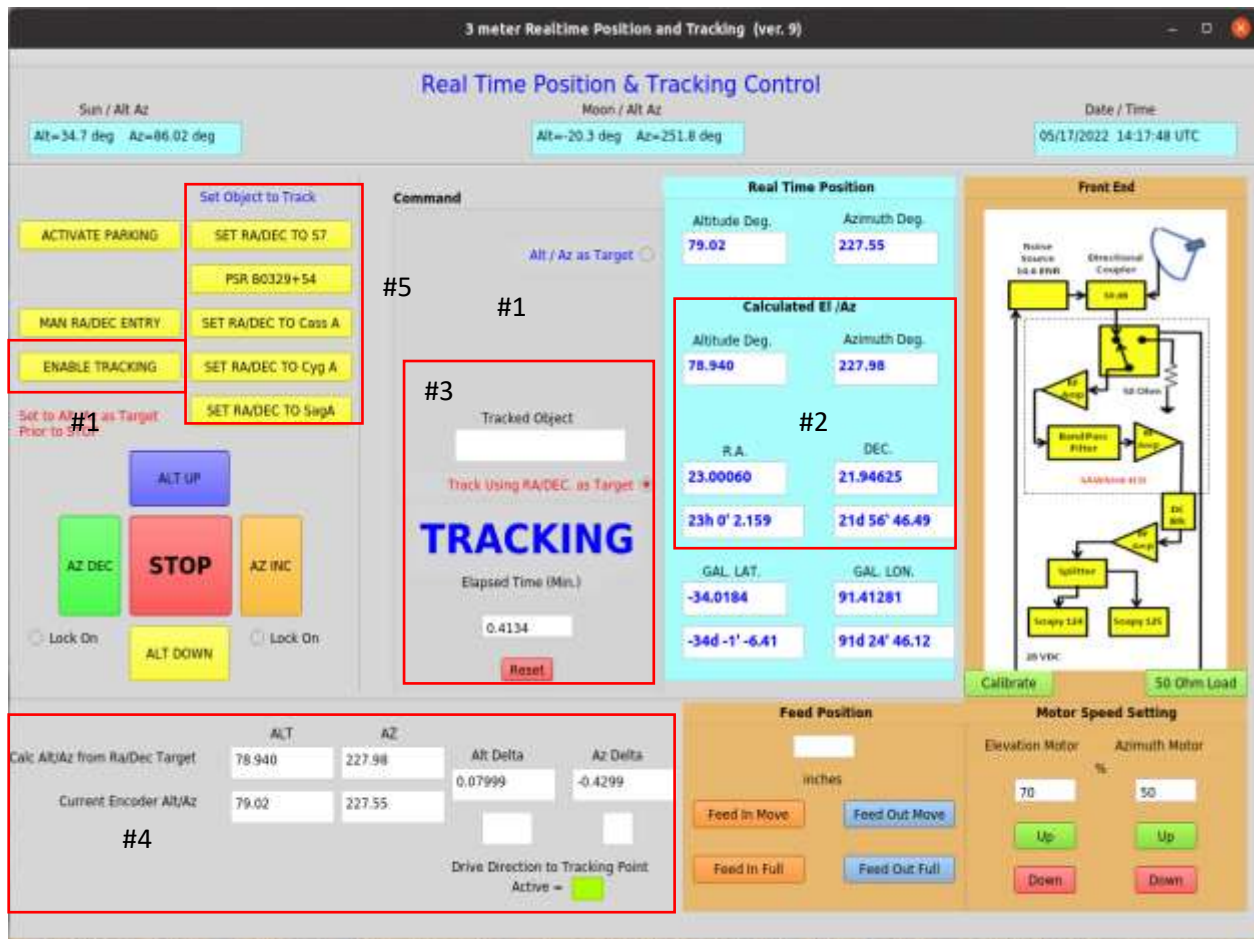

Figure 6: RTPCT GUI Tracking Mode

The RTPCT GUI also supports auxiliary functions to provide control of a calibrated noise source signal injection at the feed, and experimentally control of feed horn position relative to focus. The feed diagram, located on the right side of Figure 6, shows the calibrated noise source and its relation to the overall feed chain. This design is based on two articles[13] written by Bruce Randall. When the Calibrate button is pressed 28vdc powers the calibrated noise generator, injecting the ENR into the receiver chain. The Calibration Server is programmed for this to remain on for sixty seconds. However, this time period is fully configurable. In addition, the Calibration Server supports the switching of the 50 Ohm load built into the Nooelec SAWBird+H1b[12] LNA. In the RTPCT GUI this function is also located at the right hand side of Figure 6. This function, in the Calibration Server, is also timed to last for sixty seconds and is also configurable.

The other function which is controllable through the RTPCT GUI is the experimental control of the feed focus position. I say that this is experimental because I have no idea if it is advantageous in a practical sense, to have such function that is remotely changeable. However, I plan to experiment with different positions and report back on the Forum with the results. This hardware consists of a two-inch travel linear positioner[14] and a linear potentiometer for position feedback. It is currently set to move the feed horn +/- one inch around the calculated

focal point of the dish in small increments. On the RTPCT GUI the function’s controls are located near the bottom center of Figure 6. Figure 7, below, shows the architecture of these server functions.

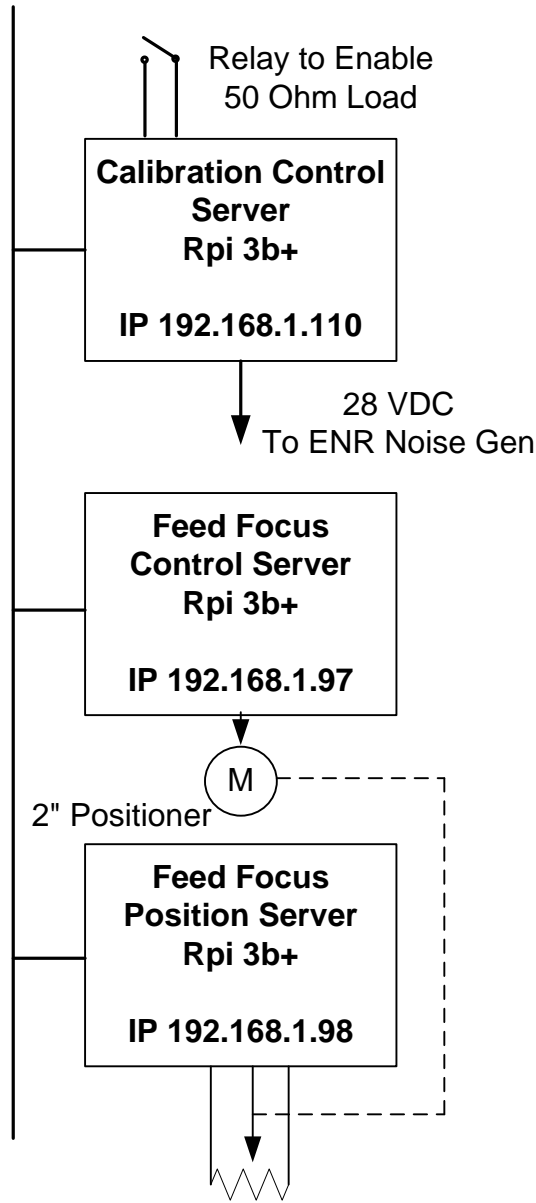

Figure 7: RTPCT Remote Servers used for Auxiliary Functions

**Conclusion**

Although this RTPCT is not an “Off-the-Shelf” type of project, it does represent the type of mounting control system that is adaptable to almost any form or size of Alt/Az mount. The software is fully configurable to allow for customization and expansion. Possible future improvements could include such things as PID motor control or servo type motor control, fewer server SBCs with more functionality per SBC, and beam scanning type algorithms as part of the tracking system.

## References:

- [1] Jack H. Lobingier, "Development of a Telescope Tracking System", Part 1 and 2. Journal of the Society of Amateur Radio Astronomy, September-October 2021 and March-April 2022.
- [2] Raspberry Pi Model 3b+, <https://www.raspberrypi.com/products/raspberry-pi-3-model-b-plus/>
- [3] Raspberry Pi Model Zero Ver 1.3, <https://www.raspberrypi.com/products/raspberry-pi-zero/>
- [4] AtomicPi, <https://ameridroid.com/products/atomic-pi>
- [5] RealVNC, <https://www.realvnc.com>
- [6] Spectro\_Radiometer, [https://github.com/ccera-astro/spectro\\_radiometer](https://github.com/ccera-astro/spectro_radiometer)
- [7] SDR Spectrometer Program II, Community Version 1.4, Astropeiler Stockert e.V., Wolfgang Herrmann
- [8] Soapy Remote, <https://github.com/pothosware/SoapyRemote>
- [9] Linear Positioner, <https://www.progressiveautomations.com/products/linear-actuator-ip66>
- [10] Incremental Encoders, <https://www.usdigital.com/products/encoders>,  
[https://www.ebay.com/sch/i.html?\\_from=R40&\\_trksid=p2380057.m570.l1313&\\_nkw=incremental+encoders&\\_sacat=0](https://www.ebay.com/sch/i.html?_from=R40&_trksid=p2380057.m570.l1313&_nkw=incremental+encoders&_sacat=0)
- [11] Radio Eyes, <https://radiosky.com/radioeyesishere.html>
- [12] SAWBird+H1 LNA, <https://www.nooelec.com/store/sawbird-h1-barebones.html>
- [13] Bruce Randall, "Radio Astronomy Receivers" and "Calibration Signal Injection with Directional Couplers", Journal of the Society of Amateur Radio Astronomy, September-October 2021 and March-April 2014. (First Article)
- [14] Linear Positioner, [https://www.ebay.com/itm/112887896341?mkcid=16&mkevt=1&mkrid=711-127632-2357-0&ssspo=R5jTtFnDRvS&sssrc=2349624&ssuid=tHs-AAPESja&var=&widget\\_ver=artemis&media=MORE](https://www.ebay.com/itm/112887896341?mkcid=16&mkevt=1&mkrid=711-127632-2357-0&ssspo=R5jTtFnDRvS&sssrc=2349624&ssuid=tHs-AAPESja&var=&widget_ver=artemis&media=MORE)

**About the author:** The author has been interested in radio astronomy since about 1983. He worked as a Systems Consultant for Honeywell and is now retired. His main interests are in the areas of hardware and software improvement moving towards lower system temperature, along with Hydrogen line and Pulsar hunting. You can contact the author at [49jhanl@gmail.com](mailto:49jhanl@gmail.com).



# Power Coupler for VLF and LF Antenna Applications

Whitham D. Reeve

---

## 1. Introduction

This is the third in a series of articles that describes VLF and LF antenna and receiver applications and accessories. The second article described the construction of VLF-LF radio frequency chokes for reducing common mode noise on loop antenna feeder cables [{Reeve20-1}](#). The chokes were designed to support the refurbished HP 10509A active loop antenna described in the first article [{Reeve20-2}](#). Two different *power couplers* for the refurbished antenna were briefly described but no design and construction details were given. The current article follows up with a detailed description of power couplers for the frequency range 10 to 100 kHz (figure 1).



Figure 1 ~ Power coupler for VLF and LF applications with multi-stage lowpass filter and power controls in an extruded aluminum enclosure. This is one of several variations built over a 3-year period for the HP 10509A loop antenna. It uses RG-316 coaxial cables from the BNC-F bulkhead connectors to the PCB, but twisted pairs work just as well at the low frequencies of operation and have been used in other variations. Image © 2021 W. Reeve

An antenna power coupler, also called *bias-tee* or *power injector*, supplies power to the active electronics in the loop antenna over the same cable used to carry the antenna signals back to the receiver. The power coupler described here is designed for supply voltages up to 30 Vdc and currents up to 200 mA. The voltage and current limits can be reasonably increased by using higher rated components. This power coupler can be used with any loop antenna or active low frequency receive-only antenna system that operates within the limits.

---

## 4. Design Considerations

The major blocks of the loop power coupler are the ac and dc coupling elements, a multistage lowpass filter, and power control (figure 2). The schematic (figure 3) shows all components that are installed on the printed circuit board (PCB). The PCB (figure 4) uses through-hole components but it could be redesigned with surface mount

technology (SMT) if necessary to reduce its size. All power control components (figure 5) are mounted separately on the enclosure panel.

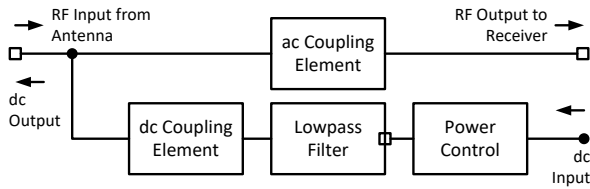

Figure 2 ~ Power coupler block diagram showing major components. Image © 2022 W. Reeve

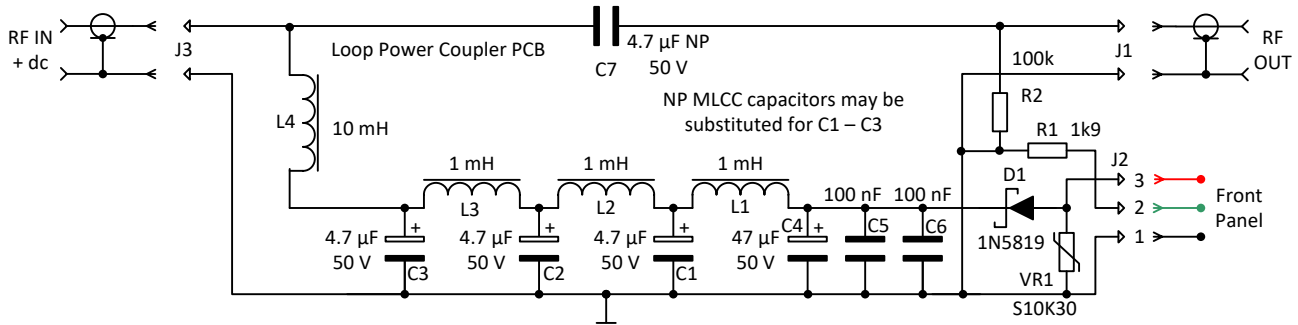

Figure 3 ~ Schematic showing the PCB-mounted components. The reactance of the inductor L4 at 32 kHz (the geometric mean operating frequency) is about 2000 kohms and provides plenty of dc power supply isolation. The multi-stage lowpass pi-filter prevents any dc supply noise from being coupled to the antenna or receiver. The combined dc resistance of the series elements in this dc circuit is 12.2 ohms (not including external power control components and assuming zero PCB ground plane resistance). R1 is a current limiting resistor for the power indicating LED on the front panel and R2 provides a discharge path to ground for C7. The PCB was built with both non-polar (NP) and polar capacitors (see text). Image © 2022 W. Reeve

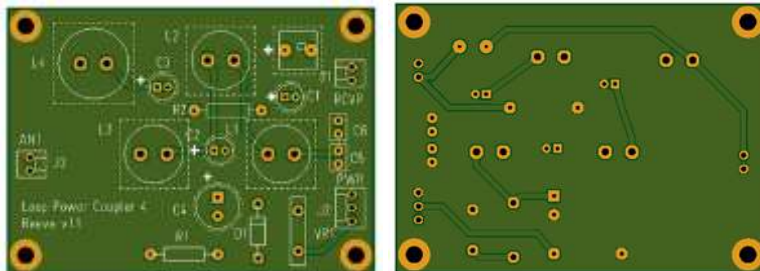

Figure 4 ~ The schematic previously shown was implemented on a printed circuit board with dimensions 70 L x 51 W mm. All components are through-hole types and latching headers are used to allow easy connection and disconnection. PCB cost is a couple dollars. It was designed with the Target 3001! PCB CAD software tool and produced by JLCPCB.

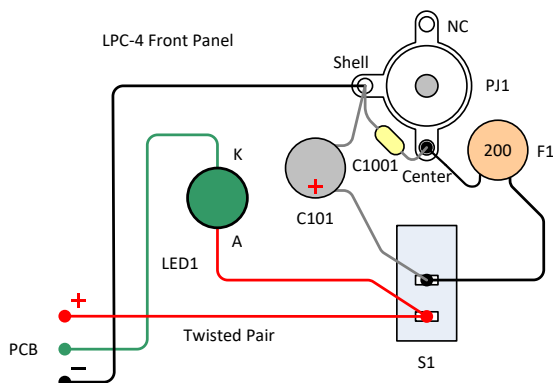

Figure 5 ~ Wiring diagram of the power control components on the front panel. The LED can have a built-in current limiting resistor or resistor R1 can be placed on the PCB to provide that function; if a built-in resistor is used, R1 is replaced by a wire jumper on the PCB or the LED cathode may be wired directly to the power connector shell. Capacitor C101 is 10 µF, 50 V and C1001 is 100 nF, 50 V. The dc resistance of the 200 mA PTC fuse is 2.8 ohms during normal operation. A miniature SPST toggle switch S1 provides the On-Off function. 24 AWG stranded twisted pair is used to connect the front panel to the PCB through a latching 3-pin connector. Image © 2022 W. Reeve

The current limit is determined by the resettable positive temperature coefficient (PTC) fuse and inductors and the voltage limit is determined by the filter capacitors. The inductors must be able to safely carry the powering current while not saturating the ferrite core. Temperature rise is used to define the safe powering current and percentage reduction in inductance is used to define the saturation current. As would be expected for wire and ferrite core inductors, a higher current raises the temperature while reducing the inductance due to the nonlinear characteristics of ferrite cores when saturated. I used the current that raises the temperature 20 °C above a 25 °C ambient. For all the inductors, this is less than the current that gives 10% inductance drop.

Other aspects of inductor applications are shielding and self-resonant frequency. The coils are in fairly close proximity on the PCB so to reduce mutual coupling, I chose shielded inductors from the Coilcraft RFS-series. Shielding adds cost but the bank does not get broken on small projects like this. The self-resonant frequency (SRF) ideally should be at least 10 times higher than the highest application frequency; however, this may not be possible with high value inductors such as used here. The inductors I used have an SRF of at least 450 kHz, 4.5 times the highest application frequency.

Important capacitor characteristics besides capacitance value include technology, temperature environment and voltage. Aluminum electrolytic capacitors are a common choice, but MLCC (MultiLayer Ceramic Capacitor) are economical in the capacitance and voltage ratings used in the filter. MLCCs do not suffer the problems associated with electrolytic capacitors such as temperature-related wearout and relatively high equivalent series resistance (ESR). MLCCs are available with many different dielectric classes or characteristics with X7R being the most common. I avoid using tantalum capacitors, mainly because they make a big, smelly mess when they fail.

I generally choose 105 °C rated electrolytic capacitors with a voltage rating 1.5 to 2.0 times higher than the working dc voltage. Other parameters affect electrolytic capacitor applications including their rated time (in hours) at rated temperature. I use the highest time rating available at a reasonable cost (usually 2000 hours). I prefer to use non-polar (NP) electrolytic capacitors or MLCC in low frequency ac coupling circuits but they can be more expensive than polar type electrolytics. As with the inductors, cost can be a factor in capacitor choice but for small projects it is not worth losing sleep over. I have built versions of the power coupler that use both electrolytic capacitors and MLCCs and they perform the same.

The lowpass filter in the dc feeder circuit reduces the noise coupled into the RF circuit from the power source and associated cabling. Filter parameters include cutoff, inband and band reject frequencies and input and output impedances. Generally, filters are designed according to a specified performance; however, in this case, I used components on-hand and then simulated it in the Almost All Digital Electronics (AADE) Filter Design software tool.

The dynamic output impedance,  $Z_{Out}$ , of the power source is estimated from

$$Z_{Out} = \frac{VR}{100} \cdot \frac{V_{Out}}{I_{Out}}$$

where  $VR$  is the output voltage regulation as a percentage, and  $V_{Out}$  and  $I_{Out}$  are the output voltage and current, respectively. Where  $VR = 2\%$ ,  $V_{Out} = 12\text{ V}$  and  $I_{Out} = 50\text{ mA}$ , then  $Z_{Out} = 9.6\text{ ohms}$  (call it 10 ohms). This impedance is assumed to be resistive. The impedance on the antenna side of the filter is based on the 50 ohm system impedance and it also is assumed to be resistive.

Under these conditions, the filter response shows several resonances and loss slopes, as determined with the AADE Filter tool (figure 6). The 3 dB corner frequency of the filter is about 100 Hz and it provides 40 dB attenuation at about 4 kHz and 60 dB at 5 kHz. Above 9 kHz, the theoretical filter loss is over 120 dB (the loop antenna and receiver lower frequency limit is 10 kHz). This filter will not reduce the fundamental powerline frequency or its lower harmonics but can reduce noise from switching power supplies and other spurious sources that couple to the power cable.

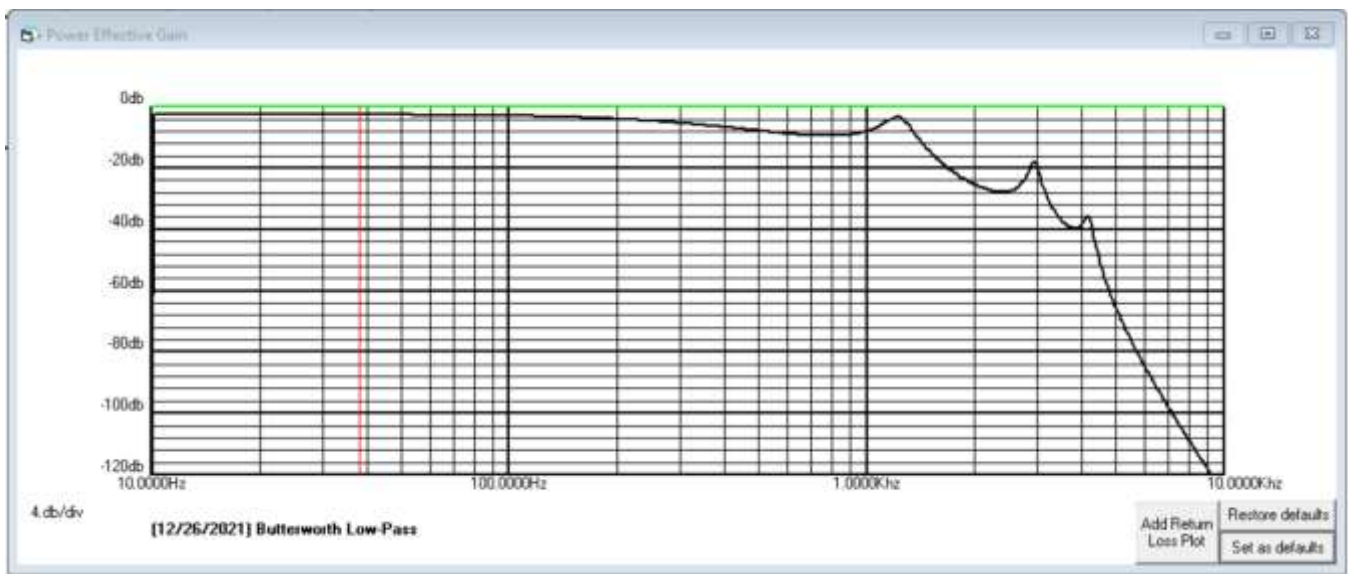

Figure 6 ~ Theoretical filter response from 10 Hz to 10 kHz with 10 ohm power supply and 50 ohm antenna impedance (both resistive). Not shown in this plot, but to be expected, are response changes if different input and output impedances are used. The red vertical line is an arbitrary cursor position. The minor tick marks on the vertical scale are 4 dB/division. An 8<sup>th</sup> order lowpass filter template was used for inputting the actual component values for simulation in the AADE Filter tool. A Q of 20 was used for all inductors. No attempt was made to optimize the filter component values; for example, the resonant peaks at 1200, 3000 and 4200 Hz could be reduced by using regular filter design procedures.

Protection circuitry consists of a 200 mA resettable PTC fuse, a 1 A, 40 V polarity guard diode and an S10K30 varistor, the latter for clamping input voltage transients. These components may be placed on the front panel with the coaxial dc power connector, power on-off switch and power indicating LED. However, the design described here has pads on the PCB for the diode and varistor so they can be populated if desired. I always try to place the overcurrent device, in this case the resettable PTC fuse, as close to the power inlet as possible, so it usually is on the front panel. I also place an electrolytic or MLCC bulk filter capacitor and a small MLCC filter capacitor on the front panel close to the power inlet. These are meant to reduce noise infiltration from the external power supply and connecting cable and are not included in the analysis of the pi-filter frequency response described above.

The power indicating LED on the front panel requires a current limiting resistor. LEDs can be obtained with built-in resistors or R1 can be placed on the PCB for this purpose. I generally operate power indicating LEDs between 7 and 10 mA and assume a voltage drop of 2.1 V across the LED. I also use very low-current (2 mA) LEDs. With a 24 Vdc input, the voltage drop across the current limiting resistor would be 21.9 V for regular LEDs. To limit the LED current to 10 mA, the resistor would be  $21.9 \text{ V} / 0.010 \text{ A} = 2190 \text{ ohms}$  and for 2 mA would be 11 kohm. For 12 Vdc input, the resistors would be 990, rounded to 1 kohm, and 4950 ohms, rounded to 5 kohm, respectively. In the 24 V example, the power would be  $(0.010 \text{ A})^2 \times 2190 \text{ ohms} = 0.219 \text{ W}$ . A 1/4 W resistor would have too little margin and would get hot, so a 1/2 W resistor would be used. With the very low-current LED, the power dissipation is only 0.04 W, so a 1/8 or 1/4 W resistor may be used.

The total dc resistance of the power control components (mainly the PTC fuse), wiring and filter and coupling components on the PCB is 15 ohms. For a 50 mA load current, the voltage drop is 0.75 V. To this is added the voltage drop across the polarity guard diode, which is on the order of 0.5 or 0.6 V. The voltage drop at full load (200 mA) is about 8 V including the diode. These voltage drops need to be taken into account to ensure the active electronics in the antenna are adequately powered, especially if they include voltage regulating components that require voltage overhead for regulation.

All components are enclosed in a metal box. For projects like this, I use extruded aluminum clamshell enclosures with dimensions 110 x 80 x 36 mm (figure 7). These enclosures are inexpensive, a few dollars each, and easy to drill. The PCB is mounted on brass hex standoffs, typically male-female, M3x6x6 mm.

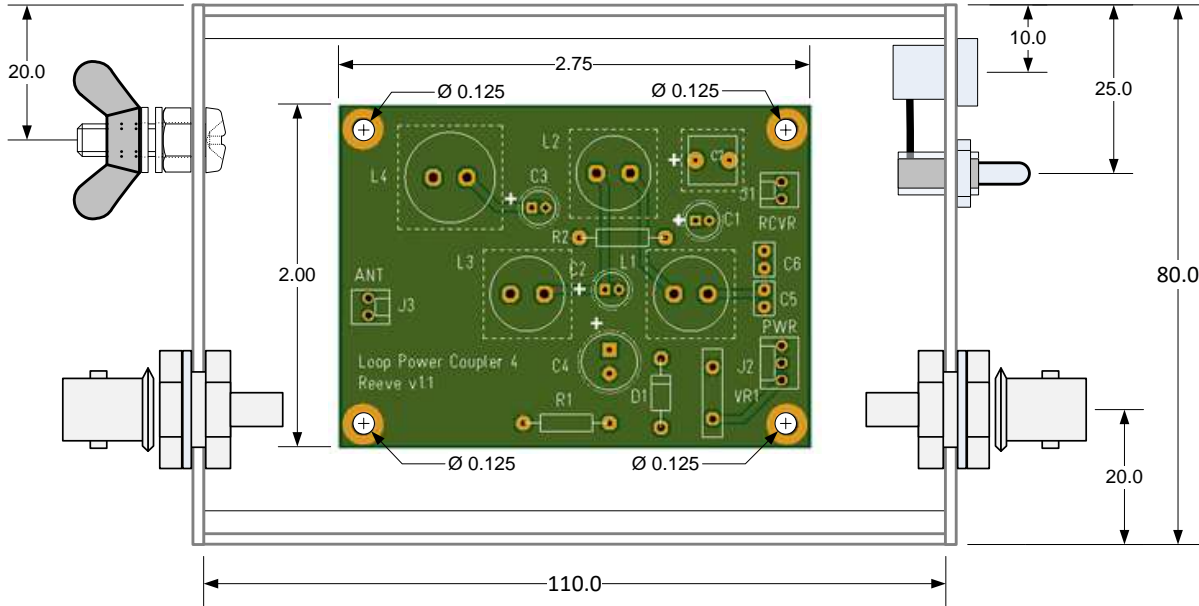

Figure 7.a ~ Enclosure interior layout shown at approximately 100% scale. The original drawing is used as a drilling template. Native dimensional units of components, either inches or millimeters, are used for convenience of shop construction and to reduce conversion errors. Image © 2022 W. Reeve



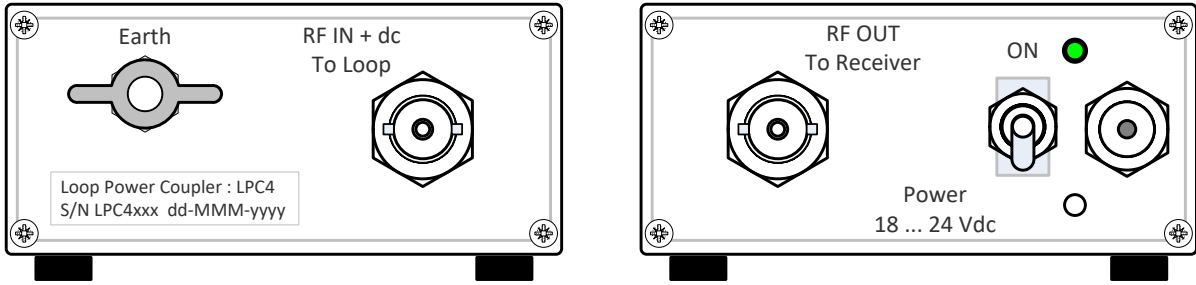

Figure 7.b ~ Front and rear panel layouts shown at approximately 100% scale. Crimp or solder-cup BNC-F connectors may be used for RF connections and a 2.1 x 5.5 mm coaxial dc power jack is used for power connections. A 10-32 stud and wing nut with washers are used for earth bonding. Image © 2022 W. Reeve

Twisted pairs or small coaxial cables can be used to connect the panel RF jacks to the PCB. I use aviation wire twisting pliers to twist two 24 AWG stranded hookup wires for this purpose. RG-316 or RG-174 are good choices if coaxial cable is used. BNC-F bulkhead mount connectors can be purchased with coaxial cable already crimped or they can be shop-assembled, or solder-cup type connectors may be used. RF and power connections to the PCB are through latching friction lock headers and wire housings to allow easy experimentation, assembly and test.

## 5. Variations

The basic power coupler design is flexible, and several variations have been built. One (figure 8) includes a linear step-down power supply that has as its input the observatory standard 12 (or 13.5) Vdc power supply voltage and outputs 8.7 Vdc for a special *wideband* (10 to 100 kHz) loop preamplifier design.

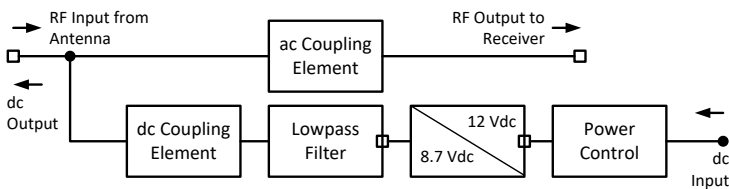

Figure 8.a ~ Block diagram of a power coupler variation with a step-down power supply. Compare to figure 2. Image © 2022 W. Reeve

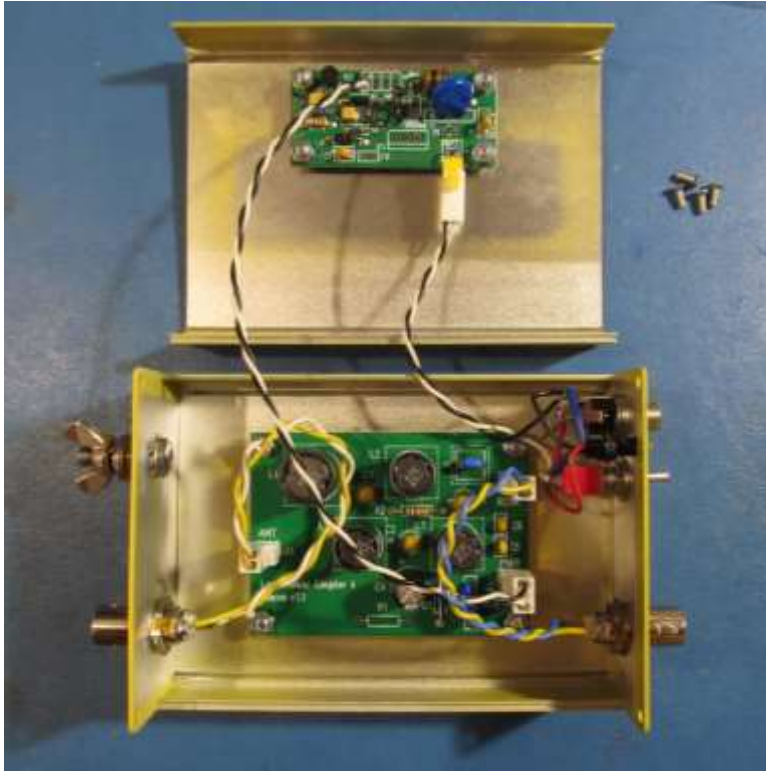

Figure 8.b ~ Alternative version with built-in step-down power supply. The bottom section of the clamshell enclosure holds the filter/power coupler PCB and the top section holds the step-down power supply. The step-down power supply uses a universal PCB that was designed for several applications. For clearance between the filter and power supply boards, the PCBs were installed with M3x4 mm brass hex standoffs. All connections are through latching wire housings and headers, which simplify experimentation and testing. This particular unit uses twisted pairs and solder-cup BNC-F bulkhead connectors for the RF connections. The enclosure was painted yellow to indicate its specific use with a similarly painted loop antenna. Image © 2022 W. Reeve

---

## 6. References and Weblinks

- {Reeve20-1} Reeve, W., RF Choke for VLF and LF Applications, 2020, available at:  
[https://www.reeve.com/Documents/Articles%20Papers/Reeve\\_VLF-LF-RFChoke.pdf](https://www.reeve.com/Documents/Articles%20Papers/Reeve_VLF-LF-RFChoke.pdf)
- {Reeve20-2} Reeve, W., Solid-State Update for the HP 10509A Loop Antenna, 2020, available at:  
[https://www.reeve.com/Documents/Articles%20Papers/Reeve\\_HP10509A\\_SSUpdate.pdf](https://www.reeve.com/Documents/Articles%20Papers/Reeve_HP10509A_SSUpdate.pdf)



**Author** – Whitham Reeve obtained B.S. and M.S. degrees in Electrical Engineering at University of Alaska Fairbanks, USA. He worked as a professional engineer and engineering firm owner/operator in the airline and telecommunications industries for more than 40 years and now manufactures electronic equipment used in radio astronomy. He also is a part-time space weather advisor for the High-frequency Active Auroral Research Program (HAARP) and a member of the HAARP Advisory Committee. He has lived in Anchorage, Alaska his entire life. Email contact: [whitreeve@gmail.com](mailto:whitreeve@gmail.com)

# Refurbishing an SRT

## Part 2: RF chain, rotor and motion control system

Wolfgang Herrmann

### 1. Introduction

This is the second part of our report on the refurbishment of a Small Radio Telescope (SRT) which we received from “Dr. Karl Remeis-Sternwarte” of the University of Nürnberg-Erlangen. In this part we cover the investigation of the low noise amplifier (LNA) and the decisions which were made related to the RF chain. We also report on the changes which were made to the rotor head and the design of the new motion control system.

### 2. Feed horn and RF chain

#### 2.1. Feed horn

The feed horn was equipped with two SMA-N adapters in order to accommodate an LNA on the SMA side and to connect low loss cables on the other side. The adapters were mounted at the location of the previous receiver: The unused C-band waveguide holds the adapters in place. Fig. 1 shows the setup with the original LNA attached.



*Fig 1: Feed horn with LNA and adapters*

A second SMA-N adapter was prepared for the second polarization or an alternate frequency range (for example 1612 MHz for OH-Maser observations). A second opening was drilled into the feed horn to accommodate the second probe.

## 2.2. Test of the RF chain using the original LNA

As a simple test, the feedhorn with was mounted on the dish where the dish was lying on the ground looking straight up, see fig. 2.



**Fig. 2:** *Preparing the first test of the receiving chain*

The original LNA from the SRT was used for a fist test. It was connected via a coaxial cable approximately 7 meters long to the receiving chain which is normally used with our 3-m dish. The chain was complemented with a bias-T to feed the LNA.

The signal did not meet expectations, it was completely erratic. It was determined that there was a strong out of band signal which obviously originated from oscillations of the LNA. Changing the bias-T against a different model did not cure the problem. For testing purposes, a different LNA was mounted which also required feeding via a bias-T. With this LNA things were normal and the hydrogen line could easily be detected.

The conclusion was that the original LNA was not unconditionally stable. We assume that a poor return loss at the output (S22) leads to the problematic behavior. In the original setup where the LNA is directly connected to the receiver this obviously did not matter. However, we concluded that the original LNA was not usable in our configuration even though it performed well under lab conditions.

### 2.3. Test of the receiving chain with an alternative LNA

As an alternative to the original LNA two modules with a SPF5189Z P-HEMT were tested. This combination has been successfully used in some of our other installation. Both modules are kept in place by semi-rigid cables as shown in fig. 3.

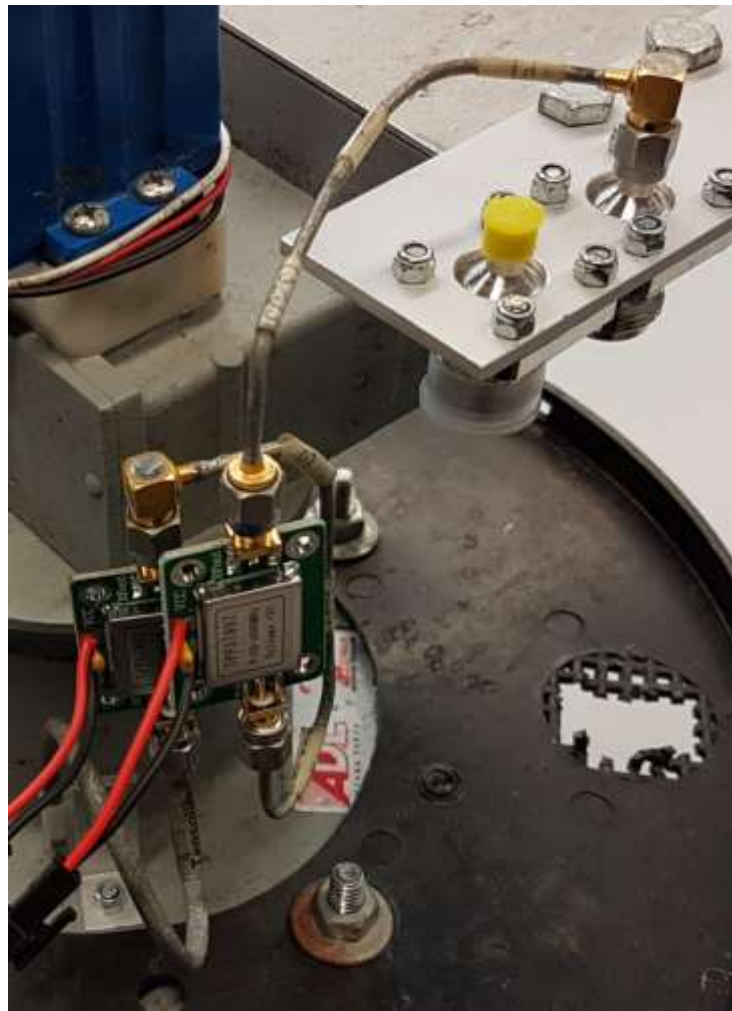

**Fig 3:** Feedhorn with alternate LNA

A successful test was performed with this combination. The spectra from neutral hydrogen were well detected. When the dish was roughly directed by hand towards the sun a signal increase could be observed. A quantitative analysis was not tried since the orientation to the sun was only very rough. The decision was taken to go for the SPF5189Z P-HEMT modules as LNA.

## Azimuth and Elevation Drive

The plan was to use the hard- and software solution from our 3-m and 1.2-m dishes with minimal changes. Both of these instruments are equipped with an EGIS rotor. This rotor has DC motors and quadrature encoders for the position feedback. The encoders measure the revolution of the DC motors. In case of the 1.2-m dish, however, a separate inclination sensor is used for elevation control.

### 2.1. Modification of the Azimuth Drive

Since the azimuth drive of the SRT does not have a quadrature encoder one had to be fitted. Unfortunately, the space was very limited and we could not find an encoder which would fit. Therefore, a homemade solution was designed. A code pattern was printed on a self-adhesive foil and affixed onto the cog wheel. Two miniature reflex light barriers were used for detection and were mounted on the frame of the housing. The solution is shown in fig. 4.

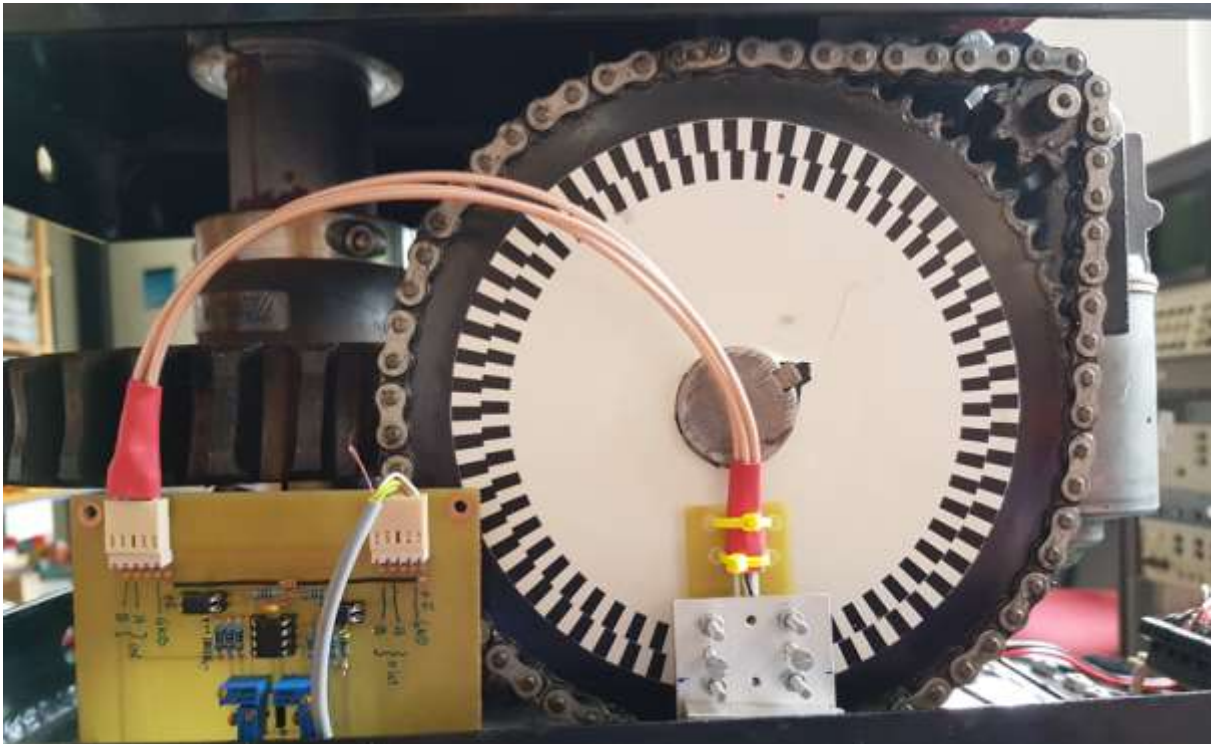

*Fig. 4: Homemade quadrature encoder on the cog wheel*

This setup delivers about 7,600 counts for a full turn in azimuth. This is equivalent to a resolution of  $0.05^\circ$  which is fully adequate.

While testing the azimuth drive for its positioning accuracy we noted that a certain amount of slack was present in the drive chain. Since the encoder does not measure directly at the axis of rotation but at a point further up in the chain, this slack is a contributing factor to the positioning accuracy. The slack was improved by modifying one bearing of the worm gear. The aim was to achieve a positioning accuracy under all conditions of  $1/10^{\text{th}}$  of the

beam width. At 21 cm the beam width is about 6.5°. After the modification the positioning accuracy was 0.5° so the target was achieved.

Another modification was related to the end switches. The original design was that the end switch interrupted the current to the motor. Motion in the opposite direction was still possible due to a diode bridging the switch. We wanted, however, also have a feedback to the control system if the end switch was actuated. Therefore, the setup was complemented by a relay board which provided this functionality.

The cabling was renewed and the feed-through of the cables into the housing was replaced. Some fresh paint gave it the final touch. See fig 5.

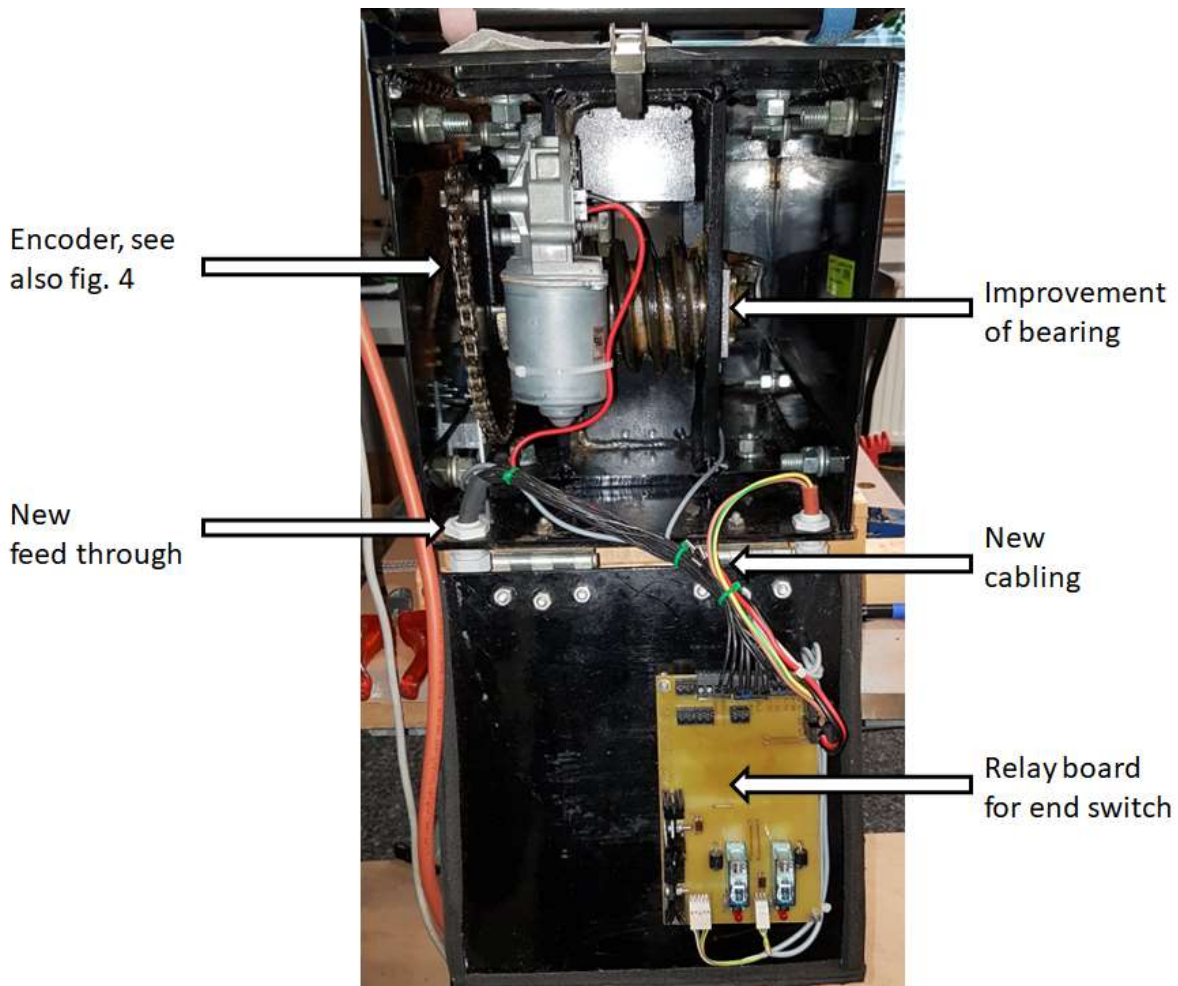

**Fig. 5:** Overview of the modifications

In contrast to the original design this unit now contains electronic components. This raised the concern that water, even when penetrating in smaller amounts might cause malfunctions. As inferred from the condition of the unit some water might penetrate via the vertical axis. In order to avoid this, the unit was fitted with a cover as shown in fig. 6.

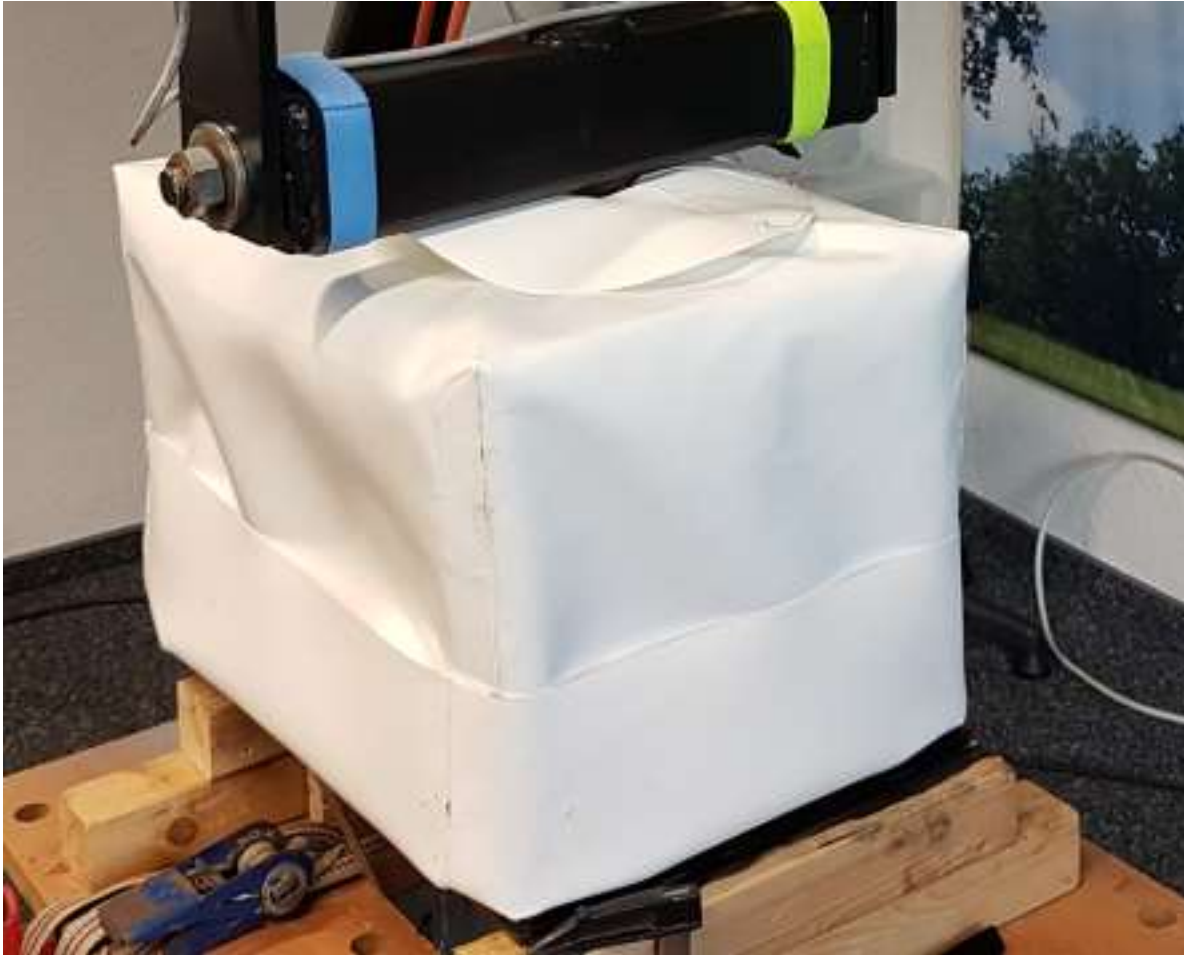
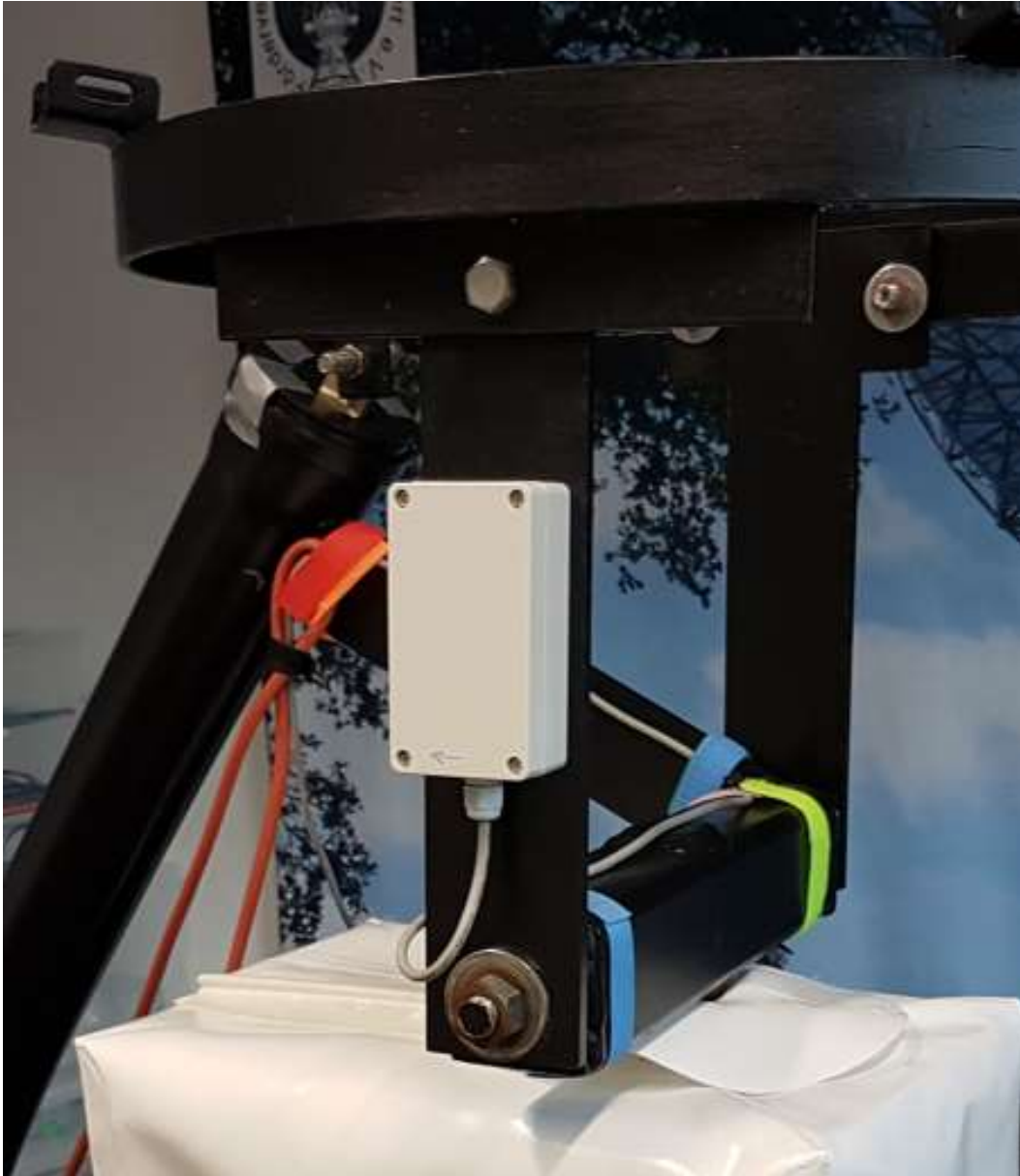

*Fig 6: Water protection cover for azimuth drive*

## **2.2. Modification of the elevation drive**

We did not find a suitable solution to complement the linear actuator with a quadrature encoder. Therefore, the decision was taken to use an inclination sensor instead of an encoder. This solution had been implemented at our 1.2-m dish and was found to be adequate for a 2.3-m dish as well. This solution is based on an ADXL 203 chip. This chip is mounted inside a watertight box which is attached to the dish mount as shown in fig. 7. This box also contains an Arduino Nano board for evaluating the data from the sensor and to provide it to the control system via an USB interface.

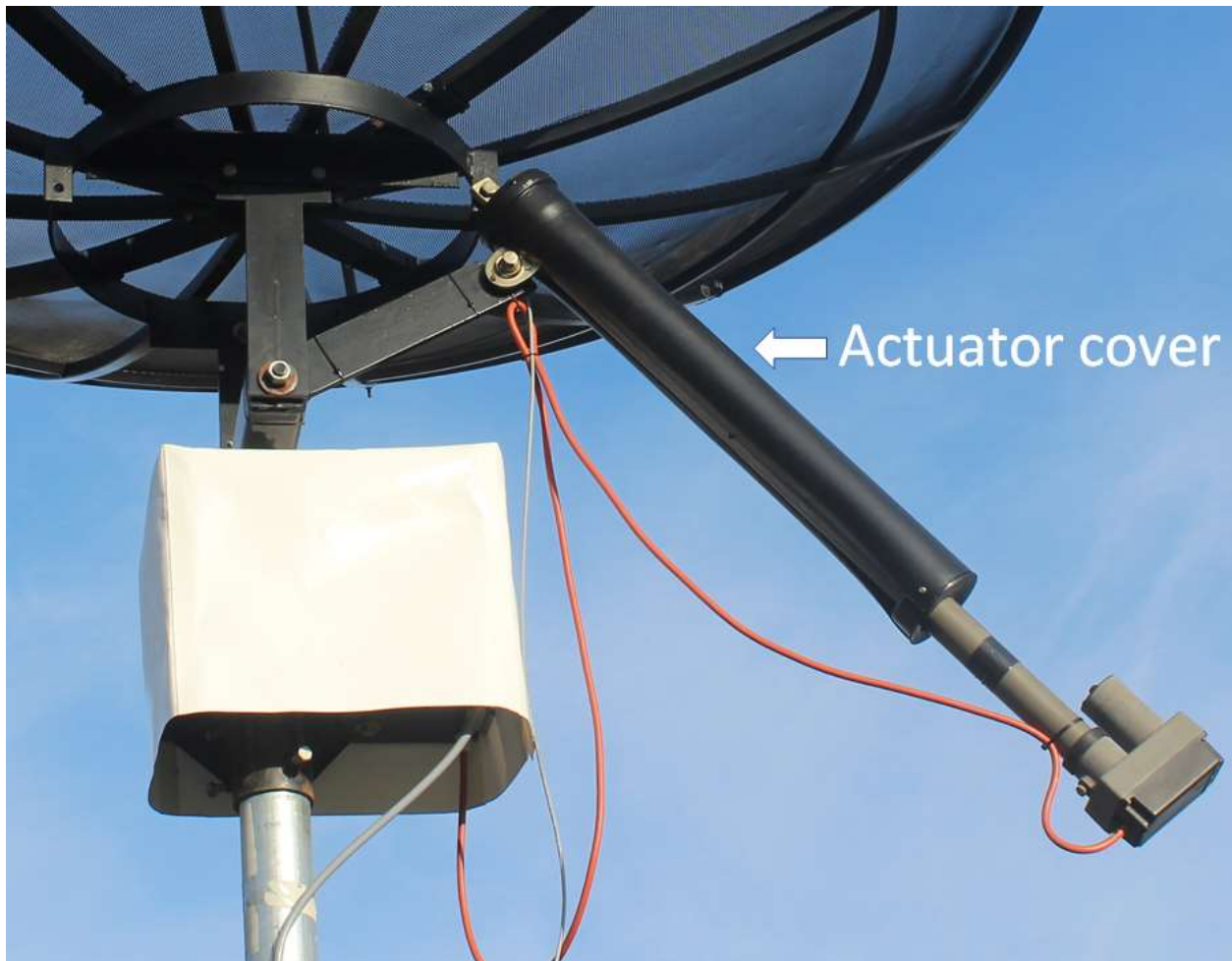



**Fig. 7:** *Elevation Sensor*

During later tests it was found that this Arduino generates some RFI so the plastic box was replaced by a metallic box to give better shielding.

The previous owner of the unit advised us that in the past there was the need to dismantle and clean the linear actuator from time to time. In order to reduce the impact from weather and to alleviate the problem, we covered the actuator by a plastic tube as shown in fig. 8.



**Fig. 8:** Linear actuator with cover

### 3. Control system

#### 3.1. Hardware of the control system

Our philosophy has been to make the system almost identical to what we use at our 3-m and 1.2-m dish. This control system consists of two main hardware components: A MD49 motor controller board made by Robot Electronics [1] and a Raspberry Pi. The MD49 motor controller board delivers the DC power for the DC motors of the azimuth and elevation drive. The board also contains counters for quadrature encoders. One of the two encoders is used for the signal from the azimuth drive. Since the elevation drive has an inclination encoder the second encoder remains unused. Communication between the MD40 board and the Raspberry Pi is via a serial interface. Power is provided to the MD49 board through a MOS switch. This allows to reset the motor controller should any of the safety circuits trip, such as the overcurrent protection. In order to adapt logic levels between 3.3V and 5V, converters are used.

As mentioned above, the elevation is measured by an ADXL 203 inclination sensor. This sensor is connected to an Arduino Nano, which calculates the elevation from the raw data of the sensors. The resulting value is transferred to the Raspberry Pi via a USB interface. An additional USB interface is available for connecting external devices. This is used for maintenance purposes when a game controller is connected to move the dish via a joystick. A block diagram of the hardware is shown in fig. 9.

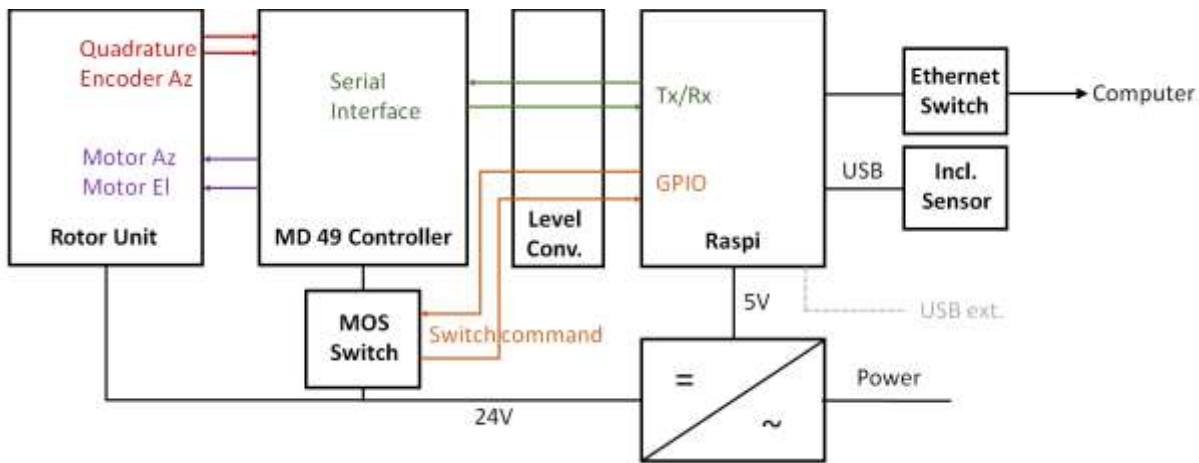

*Fig. 9: Block diagram of the control system*

The hardware is designed as Euro cards mounted in a 19" frame as shown in fig. 10.

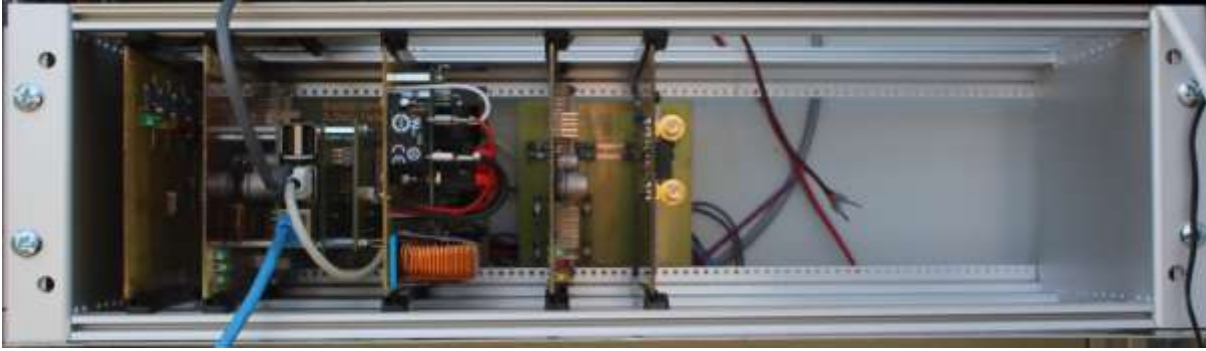

*Fig. 10: Control system hardware*

### 3.2. Control system software

The control system software is mostly identical to what is used with the 3-m and 1-2-m dishes at the Astropeller observatory. The basic philosophy of this software package is that there is a central process which maintains all information about the telescope status. It receives information from other processes and distributes this to other processes. This ensures that there is always a consistent status available to all processes. This also allows to keep different functions separated in different processes. This enables reusing telescope independent functions between different telescopes. Inter-process communication is implemented via TCP/IP. The software has been developed using Python. An overview of the different processes used for the 2.3-m dish is shown in fig. 11 below.

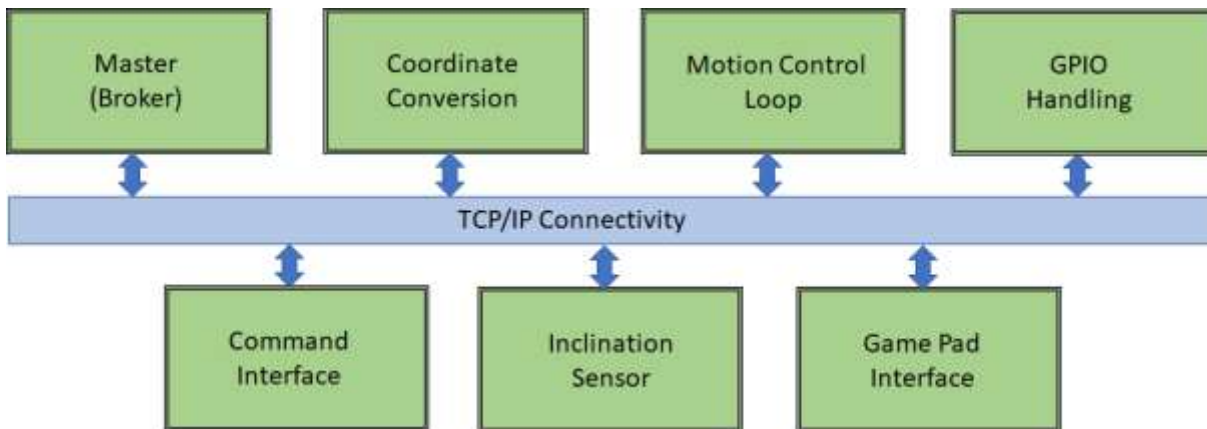

*Fig. 11: Block diagram of control system software*

The central process, called “Master” or “Broker” will initially hold fixed configuration information which is provided at system start. Then further information will be added by other processes which are started afterwards. One of these processes is the command interface. This is a text-oriented command-line interface which interprets user input to set the required information elements in the master. A typical example would be the entry of a target to be tracked by the telescope. Another process is responsible for all coordinate transformation. Equatorial coordinates will be converted to other astronomical coordinates (for example galactic coordinates). Also, azimuth and elevation are calculated as well as the corresponding machine coordinates. The inclination sensor process

reads the data from the inclination sensor and provides the actual elevation of the telescope. The motion control loop retrieves the target and actual machine coordinates from the master and provides the required input to the motor controller to implement the motion of the telescope. GPIO handling is designed to monitor end switches and to turn the motor controller power on and off. A game pad interface process will detect if a game pad is connected to the USB port. It will interpret motions of the joystick in order to move the telescope. This is mainly used for maintenance purposes.

#### 4. Integration testing

After completion of the different drive elements and the control hardware, everything was put together in the lab to test the functionality. Control loop parameters were set and stability, accuracy and repeatability of the motion was tested. Upon completion of these test, the telescope was ready for installation and commissioning. This step will be described in the next report.

#### Reference:

[1] <https://www.robot-electronics.co.uk/hm/md49tech.htm>



**About the Author:** Dr. Wolfgang Herrmann is the president of the "Astropeiler Stockert e.V.", the organization which operates the observatory.

He received his PhD in Physics from the University of Bonn. He has spent most of his professional career in the telecommunication industry. At retirement age, he now enjoys learning as much as possible about radio astronomy, doing observations and improving the instruments at Astropeiler.

Contact the author at [messbetrieb@astropeiler.de](mailto:messbetrieb@astropeiler.de)

# Python Plotting of Compressed GNU Radio Pulsar Data

Peter W East

## Abstract

This article follows on from a recent Journal article on detailed analysis of compressed pulsar data recordings collected by GNU Radio [1]. A Python program has been developed to present the data analysis in a similar form to PRESTO [2]. As well as duplicating the PRESTO sub-plots with the signal-to-noise ratio (SNR) measuring statistic replacing Chi-square, some extra graphs are introduced to strengthen pulsar validation of low SNR acquisitions. The package features speeded-up data analysis, RFI mitigation and results presentation, together better facilitating pulsar recognition confidence.

In this article results for both strong and weak pulsar acquisitions are included.

## Introduction

The technique involves compressing very long data records, as detected and averaged by the GNU Radio platform without losing any pulsar information so that many post-processing algorithms can be applied to rapidly explore detailed pulsar recognition aspects. This accelerated process produces a number of data files describing various pulsar parameters. The Python program presents the analyzed data graphically similar to PRESTO, so that parameter searches can be optimized, RFI blanked, SNR optimized and data confidently validated.

## Python Data Plots v Pulsar Properties

Figure 1 shows an outline of the Python-generated data plots. Working from top to bottom, left to right, pulsar properties confirmed in the sub-plots are:

1. *Pulse Profiles* - Correct period and Pulse width.
2. *DM Search* - Correct Dispersion Measure, Extra-terrestrial source.
3. *Period/P-dot Search* - Peak at zero offsets, Accurate Period, Highly stable period.
4. *Band SNR* - Regular pulse train, Wide-band source, SNR frequency growth, Scintillation.
5. *Cumulative SNR* - Regular pulse train, Pulse SNR time growth, Scintillation, Antenna beamshape.
6. *Target Section SNR* - Scintillation, Continuous pulsed source.
7. *Compressed Data* - Noise-like data, Minimal RFI or spikes. Possible pulse visibility.
8. *Compressed Data Spectrum* - Minimal RFI, Possible spectral lines visible.
9. *2D Period P-dot* - Complementary period/P-dot properties, -45° central ridge, No ambiguity.
10. *Data Waterfall* - SNR growth, Continuous pulse train.
11. *Band Waterfall* - Wide-band source, SNR growth, Frequency scintillation.

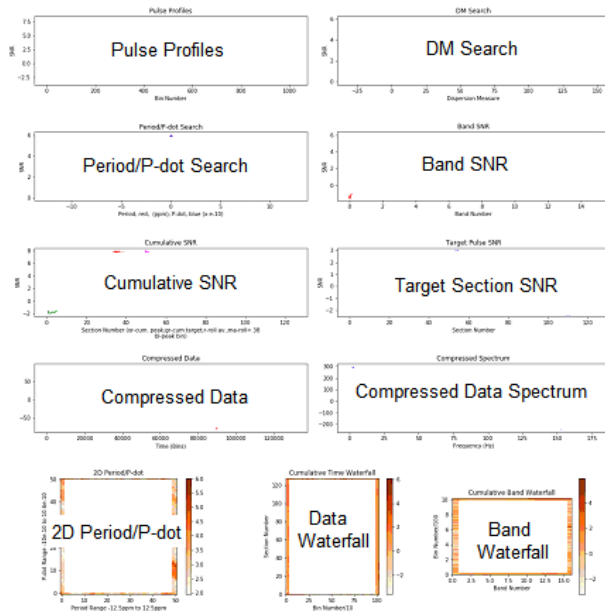

Figure 1 Python Data Presentation

New information introduced includes SNR/band and cumulative SNR in the 'Band SNR sub-plot, and the red and magenta rolling average curves in the Cumulative SNR sub-plot. In the latter, the magenta data with a selected fixed number rolling average indicates the stronger or less scintillating parts of the data record. The red dotted data monitors the peak SNR as a function of the rolling block average size, and identifies the optimum data folding region.

**Example 1. Pulsar B0329+54 @ SNR = 109:1**

**syn\_compress16** B0329\_3\_25\_21\_05min.bin 4 0.5 714.605858 128 1024 1.5 26.7 0.0 10 2 395 22

Input Data file: = B0329_3_25_21_05min.bin Pulsar Data Mode = 1 Period Range Multiplier = 10.00 Pulsar Period = 714.605858 ms Data clock= 0.50 ms Pulsar Pulse Width = 6.50 ms Pulsar Dispersion Measure = 26.70 Input file bytes = 4800000 RF Center = 395.0 MHz, RF Bandwidth = 2.0 MHz DM Band Delay = 7.192ms, No. Delay bins = 10.305 No. Data Samples = 2400000 No: FFT Bands = 4 Input Data per FFT Band = 600000	No. of Output Fold Sections = 128 ; No. bins = 1024 No. of Output samples = 131072 Working file duration = 300 secs Number of pulsar periods = 420 P-dot factor = 100 ppm adjustment = 0.00 Max Pulse ppm drift = 0.00 ms Compression Ratio = 3.28 Period Search Range = -250.00 ppm to 250.00 ppm P-dot Search Range = -119.10 ppm/100 to 119.10 ppm/100 Rolling Average Number = 22 Blanked Bands: Blanked Sections: 0
--------------------------------------------------------------------------------------------------------------------------------------------------------------------------------------------------------------------------------------------------------------------------------------------------------------------------------------------------------------------------------------------------------------------------------------------------------------	--------------------------------------------------------------------------------------------------------------------------------------------------------------------------------------------------------------------------------------------------------------------------------------------------------------------------------------------------------------------------------------------------------------------------------------------------------------

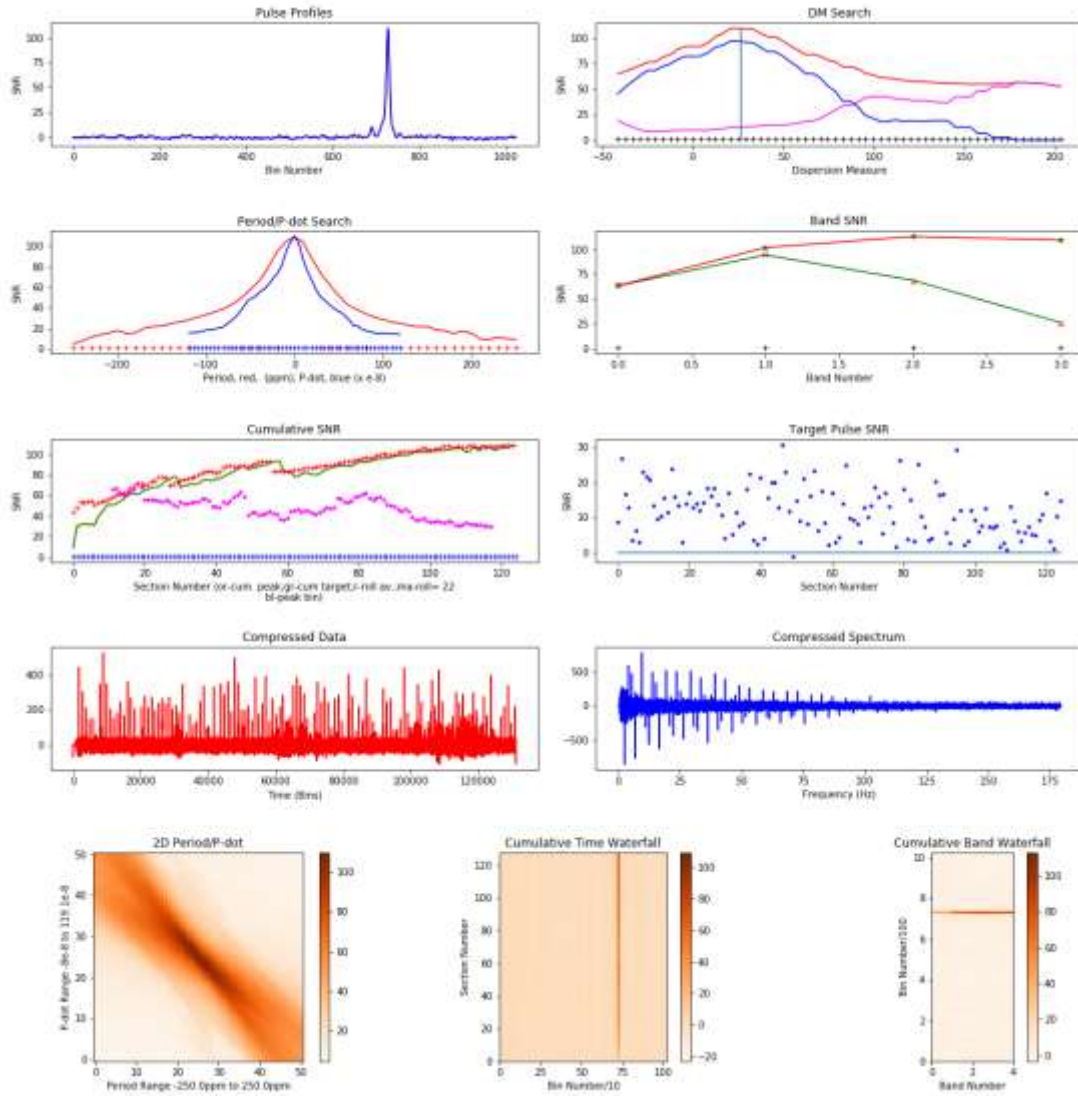

- Notes:**
1. Data provided by R. Ferranti collected with an RTL SDR and the Stanford Research Institute 46m dish
  2. The first section, 0, was effectively blanked by reducing the data amplitude by a factor of 2.
  3. Detailed descriptions of the sub-plots are given in Reference [1].
  4. `syn_compress` command line detail is listed in the Appendix.



**Example 2. Pulsar B0329+54 @ SNR = 5:1 - no RFI problems**

*syn\_compress32* airtmon1.bin 16 2 714.492092 128 1024 6.5 26.7 -.15 0 .5 10 611 32

Pulsar B0329 - 25/10/2021 Mode = 0 Period Range Multiplier = 0.50 Pulsar Period = 714.491964 ms Data clock= 2.00 ms Pulsar Pulse Width = 6.50 ms Pulsar Dispersion Measure = 26.70 Input file bytes = 537600000 No. Data Bytes = 134400000 RF Center = 611.0 MHz, RF Bandwidth = 10.0 MHz DM Band Delay = 9.716ms, No. Delay bins = 13.924 Blanked Bands: Blanked Sections: 0 No. Data Samples = 134400000	No: FFT Bands = 16 Input Data per FFT Band = 8400000 No. of Output Fold Sections 128 ; No. Bins = 1024 No. of Output samples = 131072 Working file duration = 16800 secs Number of pulsar periods = 23513 P-dot exponent = 10000 ppm adjustment = -0.15 Max Pulse ppm drift = -2.52 ms Compression Ratio = 183.70 Period Search Range = -12.50 ppm to 12.50 ppm P-dot Search Range = -10.63 ppm/10000 to 10.63 ppm/10000 Rolling Average Number = 38
------------------------------------------------------------------------------------------------------------------------------------------------------------------------------------------------------------------------------------------------------------------------------------------------------------------------------------------------------------------------------------------------------------------------------------------------	------------------------------------------------------------------------------------------------------------------------------------------------------------------------------------------------------------------------------------------------------------------------------------------------------------------------------------------------------------------------------------------------------------------------------------------------------------------------------------------

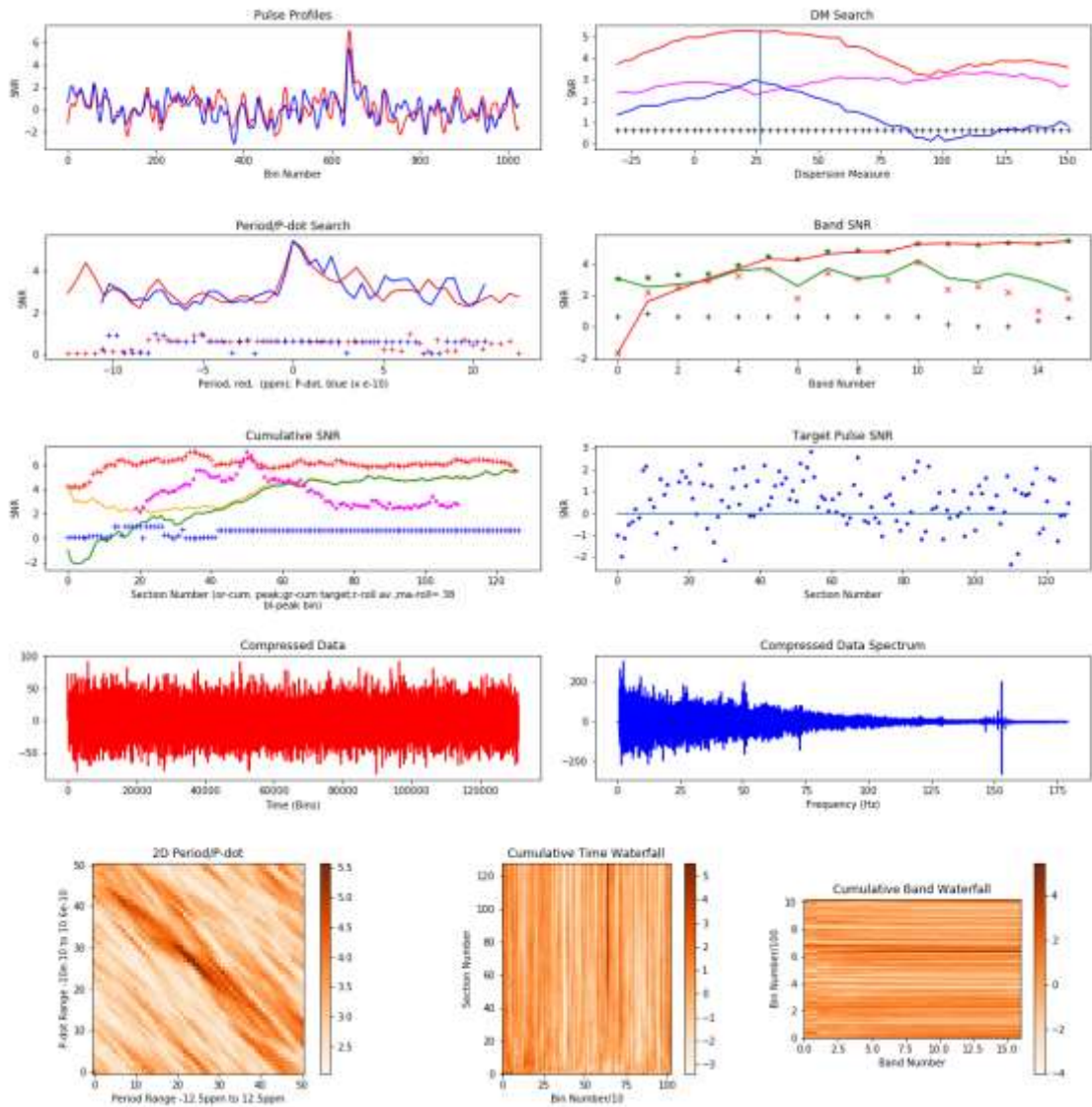

- Notes:**
1. Inspection of these data plots clearly underpins all the properties expected of a true pulsar signal acquisition.
  2. No bands and just Section 0 was blanked by reducing the data amplitude by a factor of 2.
  3. Search profiles/bin peak changes are predictable and these results are consistent with a pulse train.

**Example 3. Pulsar B0329+54 @ SNR = 4.5:1 - Modest RFI attenuated**

*syn\_compress32* airntsun1.bin 16 1 714.48825 128 1024 5.5 26.7 0 0 .5 10 611 72

Pulsar B0329 - 24/10/2021 Mode = 0 Period Range Multiplier = 0.50 Pulsar Period = 714.488250 ms Data clock= 1.00 ms Pulsar Pulse Width = 5.50 ms Pulsar Dispersion Measure = 26.70 Input file bytes = 960000000 No. Data Bytes = 240000000 RF Center = 611.0 MHz, RF Bandwidth = 10.0 MHz DM Band Delay = 9.716ms, No. Delay bins = 13.924 Blanked Bands: Blanked Sections 2 70 125 3 116 117 118 119 120 121 122 123 124 125 126 127 2 No. Data Samples = 240000000	No: FFT Bands = 16 Input Data per FFT Band = 15000000 No. of Output Fold Sections 128 ; No. Bins = 1024 No. of Output samples = 131072 Working file duration = 15000 secs Number of pulsar periods = 20994 P-dot exponent = 10000 ppm adjustment = 0.00 Max Pulse ppm drift = 0.00 ms Compression Ratio = 164.02 Period Search Range = -12.50 ppm to 12.50 ppm P-dot Search Range = -11.91 ppm/10000 to 11.91 ppm/10000 Rolling Average Number = 72 to 12.50 ppm P-dot Search Range = -11.91 ppm/10000 to 11.91 ppm/10000 Rolling Average Number = 72
-------------------------------------------------------------------------------------------------------------------------------------------------------------------------------------------------------------------------------------------------------------------------------------------------------------------------------------------------------------------------------------------------------------------------------------------------------------------------------------------------------------	-------------------------------------------------------------------------------------------------------------------------------------------------------------------------------------------------------------------------------------------------------------------------------------------------------------------------------------------------------------------------------------------------------------------------------------------------------------------------------------------------------------------------------------------------------------------------------------------------

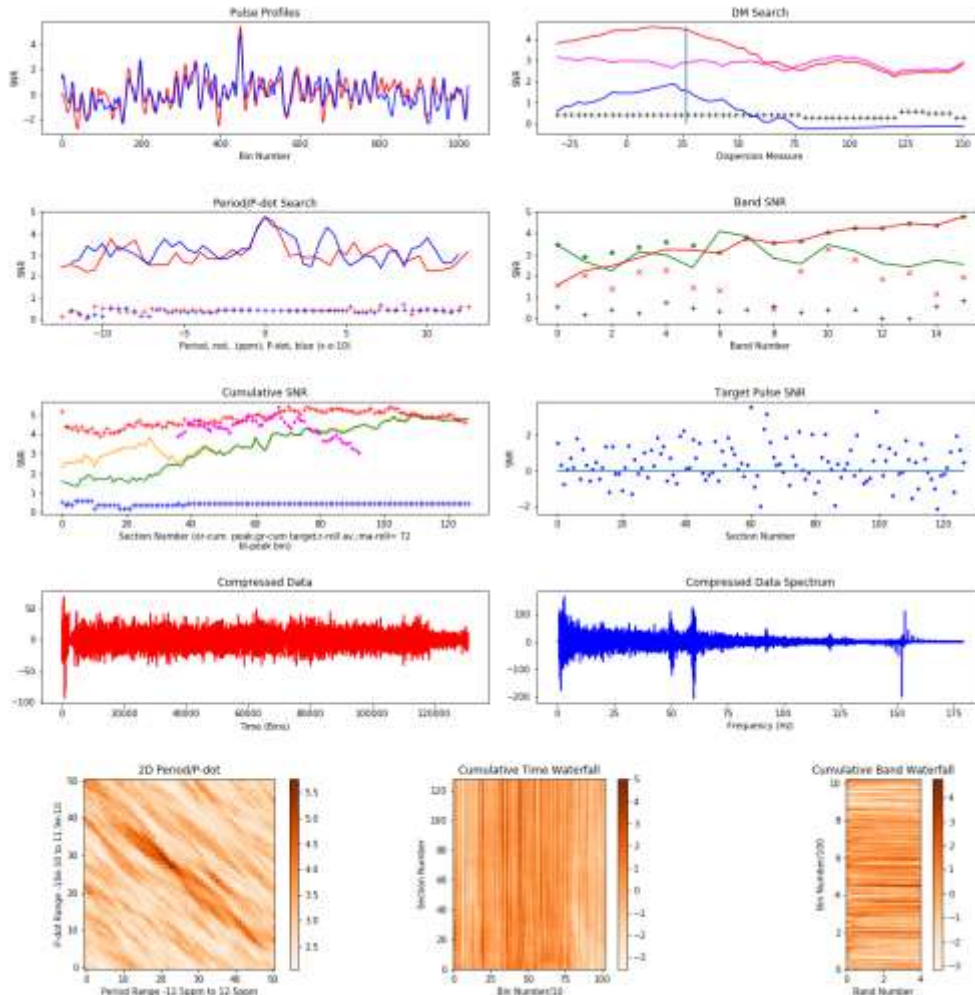

- Notes:**
1. Inspection of these data plots clearly underpins all the properties expected of a true pulsar signal acquisition.
  2. Section with modest RFI attenuated by a factor of 2 per entry including a large spike in section 2.
  3. Both low SNR examples indicate the antenna drift-scan profile in the rolling average plot.
  4. The Cumulative SNR plot indicated that an improved DM Search result may arise by stopping at section 100.

## Software

Example 1 data was recorded using the software: '*filterbank\_4ch\_2k*', offered by Hannes Fasching in Reference [3], based on work done by Andrea and Giorgio Dell'Immagine [4]. Operating under GNU Radio, the recorded data is in 2-byte binary form and is split into 4 sub-bands at a 2ksps clock rate. 5 minutes of recorded data was analyzed in '*syn\_compress*' in 18 seconds, producing 20 parameter analysis files. The test mode to optimize period matching ran in under 10 seconds. Important numerical results are listed in the command terminal. The output plots allow identification of RFI affected bands or compressed data sections for setting up band and section blanking regions. Example 2 and 3 data were recorded on two consecutive days using a variation of '*stupid\_simple\_pulsar*', designed by Marcus Leech [5]. In these examples the data is output as 32-bit binary in 16 frequency bands each at 500sps clock rate. In case 2, 4 hours 40 minutes of recording with significant data averaging was processed by '*syn\_compress*' in under 25 seconds. The initial data fold of Example 2 indicated an SNR of 4.8:1 which rose to 7.9:1 after correct de-dispersion and optimum choice of the rolling average range and central section position (38,50). Matching the expected topocentric frequency on two consecutive days within the SDR clock and TEMPO accuracy is further evidence of valid pulsar detection.

The data compression and analysis software, '*syn\_compress*' comprised two similar versions to cope with the two types of binary data and FFT band reversal (a filterbank file format version is planned). The data plotting program, '*pul\_plot.py*' based on Python3 is run under the 'Spyder IDE'.

Recording and analysis software versions for WINDOWS and LINUX are under development but can be made available for testing on request.

## Conclusions

Using the SNR statistic for examining data recordings extends the scope of pulsar data analysis and verification to much lower peak SNR levels. The data compression approach usefully reduces the operator data investigation and optimization time to provide complementary results to PRESTO as presented by the Python graphics.

The new cumulative SNR plots for both multiple bands and sections confirms pulsar scintillating presence along the record, differentiates pulse trains from noise/RFI [1]. It also adds confidence in receiver drift-scan modes by confirming extra-terrestrial signal reception by noting that the median received signal amplitude generally follows the antenna beam pattern.

The most rewarding innovation is the rolling average scheme that exploits scintillation by identifying quite clearly, the optimum regions to fold data to produce the best SNR estimate.

## Final Comments

Positively recognizing weak pulsar signals in noise and RFI is no easy task. This exercise has sought to identify and separate the various differentiating properties of pulsar pulse trains, noise and RFI and the Python plots in this article summarize most of them. There are more, as described in previous articles, the search profiles of dispersion measure, pulsar pulse train period and period rate are well-defined and matching these to the theory, also adds further confidence.

Spectral search and folding techniques on the other hand fall far short in detection sensitivity, compared to the standard fold algorithm.

Pulsar recognition prerequisites include system calibration against the Lorimer and Kramer pulsar radiometer equation, choosing a low RFI band at lower radio frequencies and, apart from pointing the antenna in the right place at the right time, ideally locking the SDR to a high stability reference oscillator [6]. A high accuracy SDR clock and using TEMPO to determine the expected topocentric period/frequency at the antenna location and observation time, conveniently narrows the search algorithms range to locate a possible pulsar target.

There are various simple checks that can be employed such as folding half records, double-period folds and half-band folds, but by far the most positive check is dispersion measure search indicating an extra-terrestrial source. Notwithstanding the power of various amateur and professional tools, there is always a finite probability that limited data sets of even pure noise can result in false identifications of weak targets. However, with intelligent use of these tools there is a very high probability of correct identification, even for some very low SNR initial indications.

## References

- [1] PW East. Detailed Evaluation of Low SNR Pulsar Data Records, Journal of the Society of Amateur Radio Astronomers., March/April 2022.
- [2] PRESTO Home, <https://www.cv.nrao.edu/~sransom/presto/>
- [3] H Fasching (OE5JFL) Pulsars - How to Detect. [https://qsl.net/oe5jfl/pulsar/detecting\\_pulsars.pdf](https://qsl.net/oe5jfl/pulsar/detecting_pulsars.pdf)
- [4] G Dell'Immagine, A Dell'Immagine. Linux pulsar software for recording and analysis. <https://github.com/gio54321/pulsar-distro-guide>
- [5] MD Leech. <https://www.ccera.ca/papers/memo-12-a-pulsar-observing-capability-at-ccera/>
- [6] DR Lorimer, M Kramer, Handbook of Pulsar Astronomy, Cambridge University Press, 2005. p 265.

PW East May 2022

## Appendix: Compression Software Command Parameters

The post processing software, *syn\_compress.exe* runs in a 64-bit command terminal (*cmd.exe* for WINDOWS) .

The command calling terms are of the form;-

```
syn_compress <binfile> <No. FFT bins><data clock (ms)><period (ms)><No. sections><No. fold bins><pulse width (ms)><DM><ppm adjust><Test T/O><ppm range factor><RF bandwidth (MHz)><RF center (MHz)><Rolling average No.>
```

Text files Blankf.txt and Blanks.txt in the working directory contain space spaced band/section numbers that are reduced in amplitude by a factor of 2 for each entry and are required. Spikes and RFI corrupted bands/sections can be identified in the terminal print out.



Peter East, [pe@y1pwe.co.uk](mailto:pe@y1pwe.co.uk) is retired from a Defense Electronics career in radar and electronic warfare system design. He has authored a book on Microwave System Design Tools, is a member of the British Astronomical Association since the early '70s and joined SARA in 2013. He has had a lifelong interest in radio astronomy; presently active in amateur detection of pulsars using SDRs, and researching low SNR pulsar recognition and analysis. He has recently written another book, 'Galactic Hydrogen and Pulsars - an Amateurs Radio Astronomy' describing his work in Radio Astronomy. He maintains an active RA website at <http://www.y1pwe.co.uk>

# Overcoming Design Deficiencies in *RigRunner* DC Distribution Panels

Whitham D. Reeve

## Introduction

The West Mountain Radio *RigRunner* power distribution panels use Anderson PowerPole connectors and automotive blade fuses for connecting and protecting multiple loads on a single source. While these panels are very useful in radio electronics installations, they suffer from at least three design deficiencies: (1) The blown fuse indicator circuit allows current to flow to the load even after the fuse has blown; (2) The blown fuse indicator LED is hidden by the installed fuses and is impossible to see under normal conditions; and (3) The PowerPole connectors cannot be equipped with retention clips and they accidentally disconnect very easily. MFJ and possibly others make very similar products, but I have never used them and do not know if they suffer the same problems. I discovered the flaws the hard way several years ago but occasionally forgot about it, leading to far more troubleshooting time than necessary on my many projects.

## Description of Flaws

Each *RigRunner* circuit includes an LED blown-fuse indicator (figure 1) through which the circuit continues to be powered at reduced voltage even though the fuse has burned opened due to overload or short circuit (flaw 1). The output voltage after the fuse has opened depends on the load. The blade fuses are fast-acting and have little tolerance to transients, which causes nuisance opening. With no load connected, full system voltage is measured with a digital multimeter (DMM) at the connector on the load side of an open fuse – a confusing indication to say the least.

The blown-fuse indicator LED glows when the fuse has opened, getting its current through the load and a 1200 ohm current limiting resistor. This assumes the load has sufficiently low impedance to allow enough current to flow to forward bias the LED. The LED is located on the internal PCB and hidden by the installed fuse (flaw 2). This has proven more of an annoyance than a safety problem (the resistor limits the current to 10 mA in a 12 V system).



Figure 1. Left: Cover removed from a *RigRunner* distribution panel. The blown-fuse indicator LEDs on the printed circuit board can be seen just to the right of and between the two fuse blade sockets. The 1200 ohm current limiting resistors are visible below and to the right of the LEDs. Right: The LEDs are invisible under normal lighting conditions. A faint glow can be seen when a fuse blows and the ambient light is low. These images show early versions of the distribution panel with through-hole resistors and LEDs. Later versions use surface mounted devices (SMD).

The accidental disconnection of a connector (flaw 3) is another serious annoyance, especially at remote sites. The PowerPole connector contacts have very little retention force. It is quite easy to simply brush up against a connector and accidentally disconnect it. The connectors easily fall out while simply dressing the many power cables associated with a *RigRunner*. In some cases, it is not obvious the connector has fallen out or is ready to fall out.

### Solutions

Remove power, all fuses and power distribution cables from the distribution panel. Remove the cover and proceed as follows:

Flaw 1 and Flaw 2: Simply remove the LED current limiting resistor or LED from each circuit. I cut the through-hole resistor leads (figure 2). For the SMD resistors on the more recent panels, I cut the resistor body while heating one end with a soldering iron and then removed the other end. Since the LEDs cannot be seen anyway, nothing is lost but now the circuit will completely open if a fuse blows. Troubleshooting with a DMM will be much easier and much less confusing;



Figure 2. Removal of LED current limiting resistors (through-hole types). The resistor leads have been cut and the bodies discarded. Compare to left side of figure 1.



Figure 3. Cover for a 12-circuit distribution panel. The metal webs between the PowerPole connectors have been removed with a nibbler tool. The fuse slots are immediately above the cutout area. Compare to the right side of figure 1.

Flaw 3: Use a nibbler tool to cut the metal web on the cover between each PowerPole connector (figure 3). Also, notch out each end about 1/4 in (6 mm) to provide clearance for the retention clips on the end connectors. Place the cover in a vise with wood protecting blocks on the jaws and file the cuts smooth. Clean up metal dust and replace the cover (figure 4-left). Now, the retention clips can be inserted onto either side of the connectors (figure 4-right).

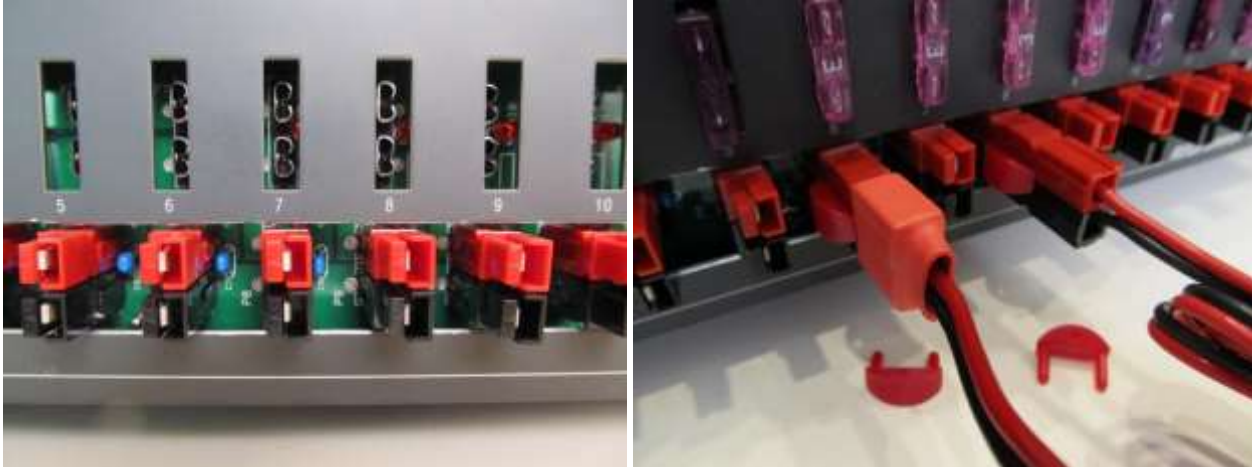

Figure 4. Left: Cover in place and modifications completed. Now, the retention clips can be inserted on either side to hold the connectors in place. Right: Retention clips in-place on two of the connectors with a couple extra clips immediately below. Only a little dexterity is needed to fit the clips, which securely hold the connectors in-place.

Comments: Do these modifications at your own risk and peril. RigRunner panels carry a 1 year warranty, which states in part: .... *Warranty does not cover damage caused by abuse, accident, misuse, improper or abnormal usage, failure to follow instructions, improper installation, alteration, ....* The modifications described here fall under the “alteration” category (and probably under the “abuse” category as well) so, obviously, these modifications void any remaining warranty on the units to be modified.

---

## Special Note:

These observation reports are from SARA members and have not been verified by peer review.

These observations are included in the journal to allow for discussion on improving the SARA member's observation system.

Some observations may be **false positives**, therefore the SARA staff requests that recommendations to improve the observation be addressed directly to the author.

### Detection of Pulsar B0329+54 with J.R.T. [Job's Radio Telescope - 1.9 meter]

Job Geheniau

As I have been working on some more complex (amateur) radio astronomy projects (for example high velocity clouds) for some time now, I was advised by Michiel Klaassen to delve into the pulsar detecting methods and attempt to capture the pulsar B0329+54. A very challenging task.

A pulsar (from pulsating radio source) is a strongly magnetized rotating neutron star that emits beams of electromagnetic radiation from its magnetic poles. Figure 1.

This radiation can only be seen when the beam is directed toward the Earth (just as a lighthouse can only be seen when the light is directed toward an observer), and is responsible for the pulsar radiation's radiance. Neutron stars are very dense and have short, regular periods of rotation. This creates a very precise interval between pulses, which for an individual pulsar ranges from milliseconds to seconds.

PSR B0329+54 is a pulsar about 3,460 light years away in the constellation Camelopardalis. It rotates every 0.71452 seconds and is about 5 million years old.[1]

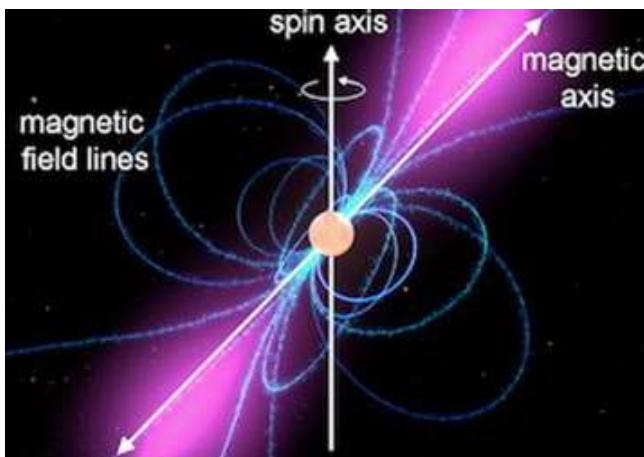

Figure 1. Pulsar



The challenge also lies in the fact that the dish 'only' has a diameter of 1.9 meters and that I started working with the current configuration:

- 1.9 meter mesh dish (1.5 meter RF Hamdesign extended). Figure 2.
- Feed tuned to 1420 MHz.
- ZX60-ULN33+ Mini Circuits LNA (low-noise amplifier). Figure 3.
- Interdigital bandfilter tuned at 1420 MHz.
- 2nd ZX60-ULN33+ Mini Circuits LNA (low-noise amplifier).
- Nooelec Smart SDR.
- rtl\_sdr software.



Figure 2. The dish:



Figure 3. Rf chain:

The first advice I got from Michiel was to use a Nooelec Smart sdr (software defined radio) because those are more stable regarding frequency and sample drift. Normally I use an Airspy mini or a rtl2dr.

Also, at first, my recording computer was a Windows10 computer. That operating system seems to do a lot of tasks in the background which can influence the gathering of enormous amounts of data. In short, a small investment was needed and for the pulsar recordings I now use a Nooelec Smart sdr connected to a secondhand Windows XP computer. Figure 4.

Before I had all software running on the XP computer it took me 2 days because most software is no longer supported. Biggest solved problem was the remote software. Teamviewer and Chrome Remote no longer work on Windows XP, but luckily AnyDesk still does.

Nice detail, all this hard- and software is completely remote controlled (50 km away) due to the fact that I live in a city with a lot of rfi (radio frequency interference) and no place for a dish. Thanks to my parents who agreed to use their roof for my dish. For the future I am looking for a new/better place to put my dish (maybe > 3 meter) for improvement of the observations.

Fig 4. The hardware at the remote location (Macbook (running AnyDesk) was for testing that day, under the Macbook the windows XP computer for the pulsar detection)

In this configuration you see a monitor, a Windows10 computer (Pst rotator, Radio-Eyes and software like SDR# and Virgo), a home build 230 Volt netfilter, a power supply for rotator (13.8 Volt) and the rotator hardware. On the left the Windows XP computer and in between the Nooelec SDR and Bias-Tee.:



Figure 4

The software that is used was written by Michiel Klaassen and can be found on his website under project 17. <http://parac.eu/projects.htm>

To be divided in 4 processes:

- 1) **Recording** with application rtl\_sdr.exe
- 2) **Processing** data with application 3pt-calc-105.exe
- 3) **Plotting** the data with application 3pt-plot-105c.exe
- 4) Possibly make the pulsar **audible** (artificial) with application pa31.exe

I don't want to go too deep into the operation of this software in this article, if only because of the fact that I did not write the software.

The operation is structurally different from, say, SDR# because we are dealing with a pulse and not a continuous signal. As Michiel himself describes it:

#### Measurement of HI.

This is a, in time constant, signal. To get a stronger signal, there are several possibilities. One is stacking or integrating. This involves putting a number of samples into a register. On these samples an FFT function is performed. The result is a spectrum. This is added each time in a sum register. For example, Cfrad adds 100000 spectra in 5 minutes. After 5 minutes, the final result is divided by 100000 and written to disk as a file. As a reference or "dark", an area with little HI is looked at. The first two files are often used as ref (2X5 minutes). If there is a lot of RFI, curve fitting can also be used.

The ref is now used to correct the other measurements for the non-flat passband, so;  $\text{correct measurement} = \text{measurement} * 1/\text{ref} = \text{my (Michiel) method.}$

**The result is an amplitude plot as a function of frequency.**

#### Measuring pulsars.

This is a time varying but repeating signal. Again, the signal is so small that summation is required. However, this cannot be done immediately. Because of the greater delay of the low-frequency signal relative to the high-frequency part (DM), the peaks come in one after the other, as it were. Direct summing makes no sense. One way to solve this is to take a number of samples in a register and then take the FFT. Then divide that frequency band into 10 or 20 parts. Each bin of the frequency band is now shifted more or less (de-dispersed) and written to the file. In the plot script, all 10 or 20 spectrum band bins are shown. All spectrum band bins are now added up and give the pulsar profile.

Adding all corrected periods gives the same result. By writing the spectra bins per period to file, a summation decision can be made per period; e.g. an RFI rich channel can be excluded from summation.

Also, you can see individual pulses=my (Michiel) method.

**The result is an amplitude plot as a function of time. [2]**

Process 1, Recording with application rtl\_sdr.exe

After the coordinates (03h:32m:59s 54d:34m:44s) are entered in Radio-Eyes and the dish is tracking the pulsar with the rotator, PsT Rotator software, (on a bright day), I start rtl\_sdr.exe which contains several parameters.

Sample frequency 1418 MHz (no interference from HI), bandwidth 2 MHz, auto gain.

This produces a file (dump.bin) of about 17 Gbyte in one hour.

After recording, the file is sent remotely via (slow ☺) Internet to The Hague for processing.

It is important to write down the date and time and the location, as these are needed in the later processing of the data.

Process 2, Processing data with application 3pt-calc-105.exe

From the dump.bin file, the individual periods are calculated. In the configuration file of 3pt-calc-105.exe you specify the parameters. In my case the pulsar name (B0329+54), the pulsar period (0.7146 sec), the sample rate (2 MHz), the DM (26.776)

[In pulsar astronomy a handy quantity is the dispersion measure (DM) of a pulsar, which manifests itself observationally as a broadening of an otherwise sharp pulse when a pulsar is observed over a finite bandwidth, so the higher frequency signals are received earlier than the lower frequencies. This is called dispersion, caused by the interstellar free electrons.] [3]

And finally, we enter the number of bins (108 which is best for B0329+54) in the configuration file. This produces a large number of period.txt files (just around 5000 per hour).

Since it would cause problems in stacking with the wrong folding time, it is important to know the exact pulsar period at the right location, date and time. In my case period time [s]=0.714534770842

The optimal folding time can be found for instance with the application 2pc-53.exe, also available from Michiel Klaassen on his website.

Process 3, Plotting the data with application 3pt-plot-105c.exe

Now comes the exciting part! The trick is to find the right periods from the periods in which the pulsar is most/best visible. Using Fast Fourier Transform and folding the right periods (to improve SNR ratio) divided over bins, this application eventually produces a plot in which the pulsar is (hopefully) visible. For the technical information about folding, I would like to refer to the article in the May/June 2021 SARA Journal by Peter W. East.

Process 4, making the pulsar audible (artificial) with application pa31.exe

It is also possible, using the collected periods, to make the pulsar audible as an audio click. Again, the periods are stacked and the pulsar rises audibly above the noise.

Result:

On May 14, 2022, at 15:02 UTC, a clear pulse is seen for the first time that is not initially due to rfi, as far as I know. Fig 5.

For the time being, I am keeping it that this is a recorded moment of the pulsar B0329+54 with JRT. Of course, I will try to detect the pulsar more often to have certainty that my assumption is correct. It is namely a relatively small dish and it would be the first time that with an 1.9 meter dish and the software this pulsar has been registered.

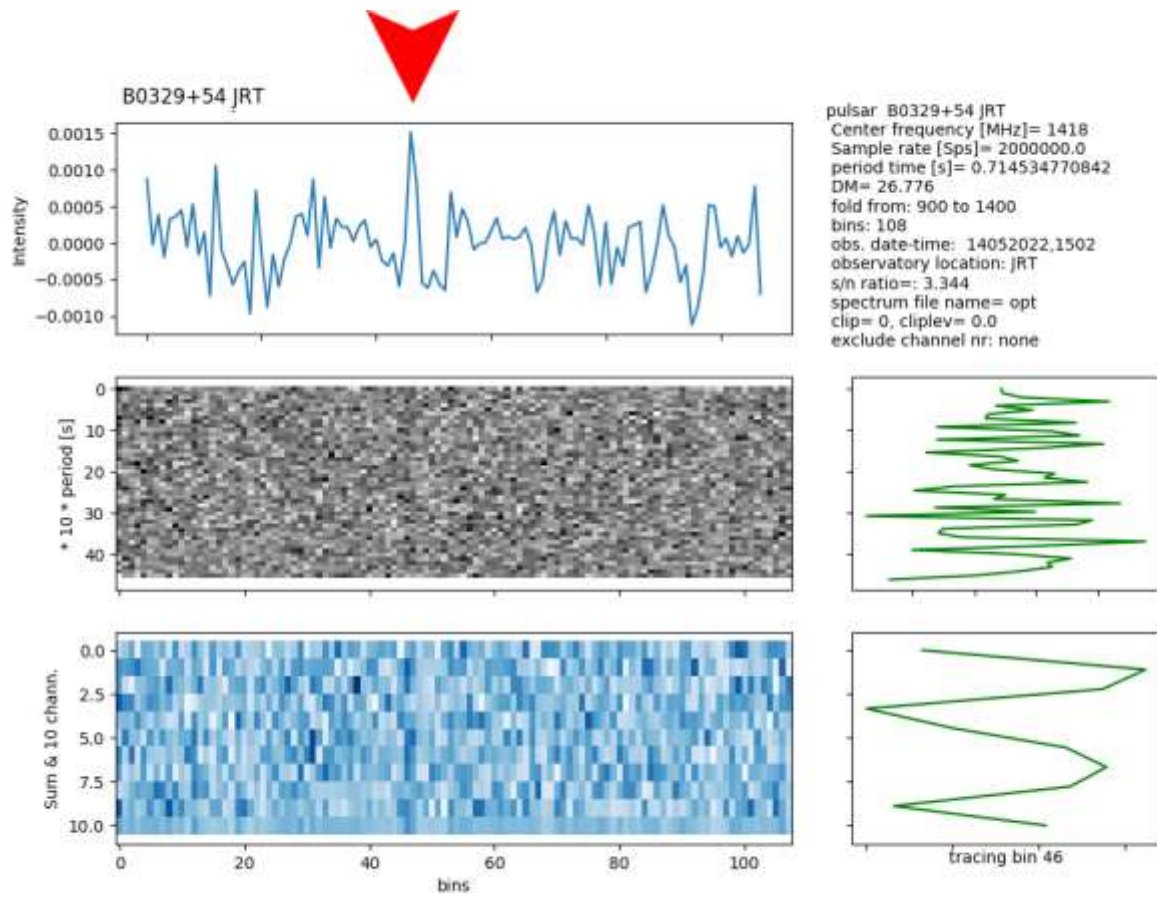

Figure 5. The detected pulsar

To be continued in the near future.

[19 june 2022]

News Flash.

After several negative attempts (first two weeks of June) I seems like a second positive result for the 1.9 dish for Pulsar B0329+54. This is a major step in confirming the registration of the pulsar. Figure 6

I did not use channel 1 and 10 for stacking.

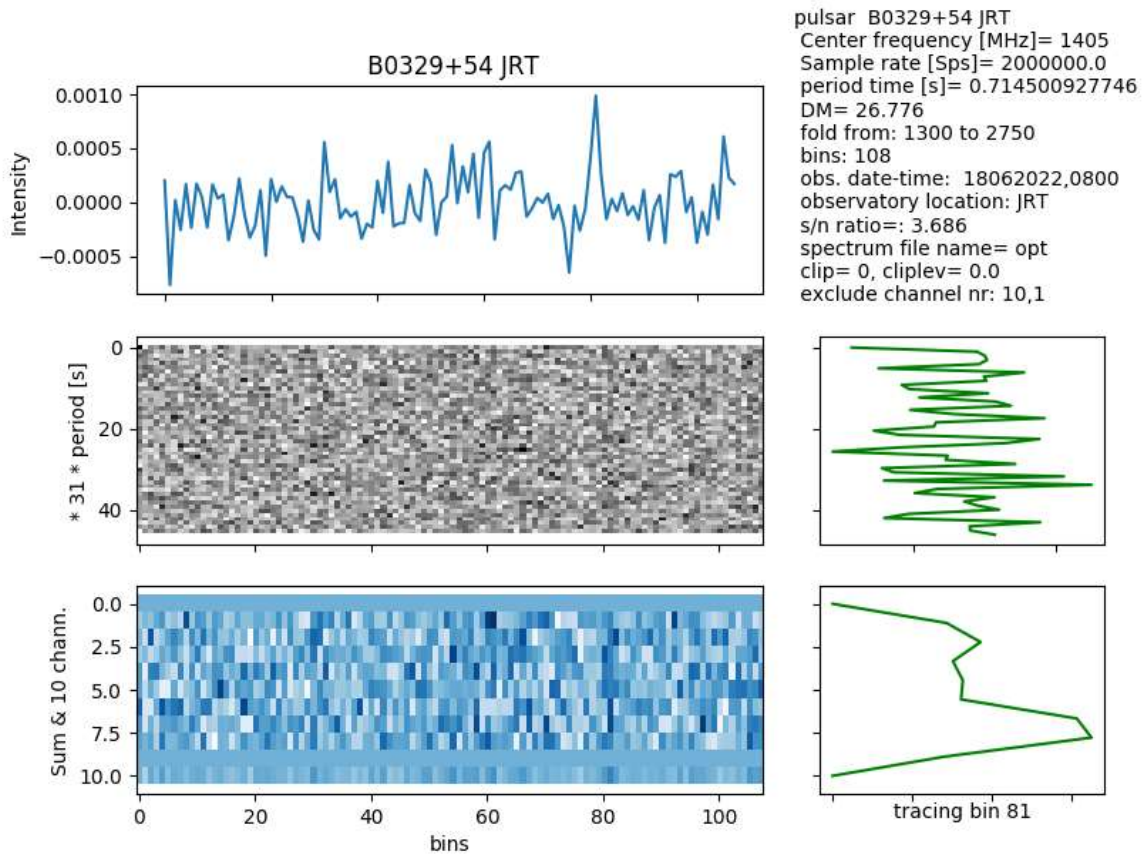

Figure 6

This registration + the audio video and all other projects that I have done with JRT can be found on my (new) website:

<https://jgeheniau.wixsite.com/radio-astronomy>

<https://jgeheniau.wixsite.com/radio-astronomy/pulsar>

#### References:

- [1] Wikipedia
- [2] Michiel Klaassen
- [3] <https://astronomy.swin.edu.au/cosmos/p/pulsar+dispersion+measure>

Job Geheniau, 56 years old, married and 2 children, is a teacher in Broadcast Studio Camera's and TV Direction and Video Editing.

Astrophotography ( <http://www.jgeheniau.nl/etx90/astronomy2.html> ), meteor detection with radio ( <https://jgeheniau.wixsite.com/radioastronomy> ), weather satellite and ISS SSTV receiving and everything else with radio has his interest.

Most of all, amateur radio astronomy plays an important role in his live.

# Spectral Analysis of an H1 Hydrogen Emission Region within the Milky Way Using an Enhanced " SARA Scope\_in\_a\_Box " Radio Telescope

B Alex Pettit Jr KK4VB

Beginning with the purchase of a set of SARA Scope-in-a-Box components in August 2021, testing and upgrading the antenna configuration and electronic components, and the development of processing techniques has been an incremental, experimental and on-going effort.

## Here is a Progress Report

### Hardware

The Dipole was replaced with a tuned Loop Feed derived from a design by OM6AA. Tests showed a worthwhile improvement in signal strength. The nooelec SAWBird H1 LNA/Filter was replaced with a set of components from Tom Henderson WD5AGO. The LNA was moved from the antenna base directly to the Loop\_Feed input, and the SDR was upgraded to an AirSpy Mini.

Stock nooelec Dipole Feed



1.42 GHz Loop Feed



As an experiment, side panels were added to improve the SNR of the antenna, The intent was not to increase the size of the dish and gain signal enhancement, but to shield the loop-feed's 'over-illumination' pattern from ground noise.

The panels were well worth the effort as the reduction in background noise was unexpectedly large, and there was a gain in signal strength and a lessening of the 'random' RFI pickup.



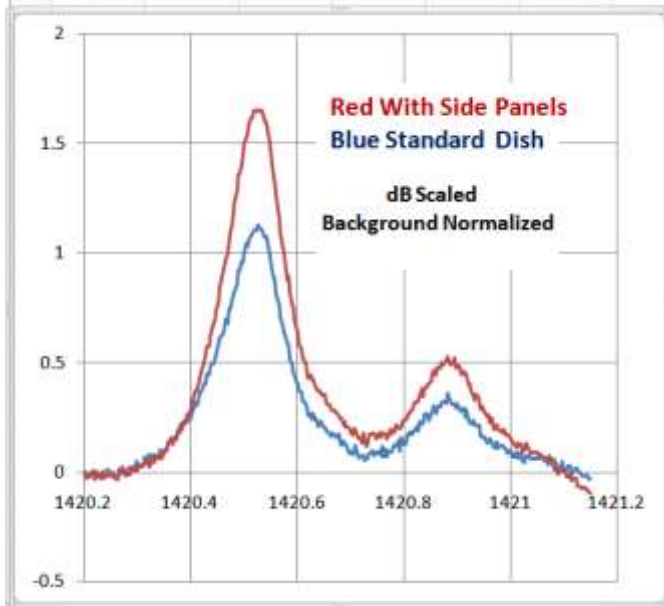
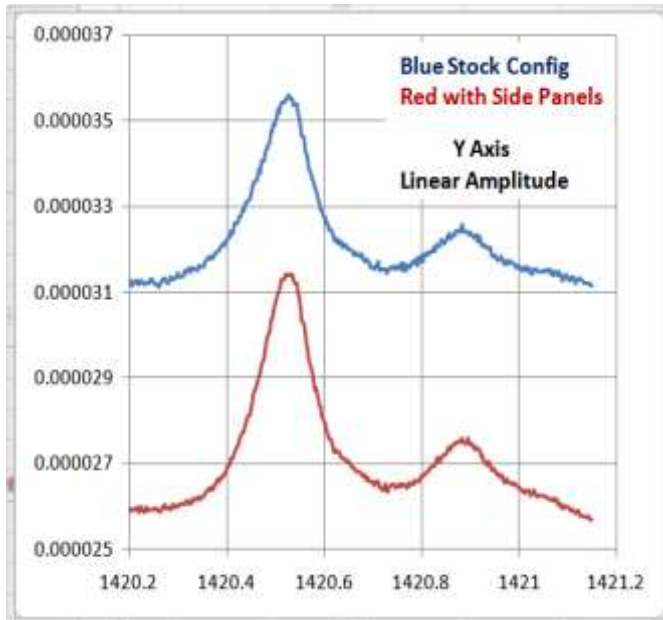

## Software

For data acquisition, AirSpy SDR# Studio with the Daniel Kaminski IF\_Avg Plug-in were used. This Plug-in allows an initial Calibration File to be generated to correct for background noise and filter ripple. Data can be normalized by this File, and long averages acquired and auto-sequentially labeled and stored in two-column Frequency/Amplitude text-files. This Software was essential to the data acquisition sequence and is Included with the SARA Scope-in-a-Box system .

## Data Processing and Results

Having finally arrived at a good configuration, several hours of acquisitions were taken in the stronger emission areas of the Milky Way. This data is from an 8 hour scan through RA 16hr to 24hr at Dec +40 Dg , 28 March 2022.

Processing of the data was via software scripts using Mathworks Matlab .

( some of these processes have been automated, but the software is in the early test/development stage )

**Amplitude:**

Square the linear IF\_Avg amplitude data to convert it to power values.

Calculate the average background noise in a non H1 spectral region for each sample and select the Lowest.

Correct the difference from It to each data set and normalize their background noise to the Lowest to remove shifts.

Convert to dB ( power ) and set the background reference level to '0' dB.

**Spectrum:**

Convert Frequency spectrum to a Doppler Shifted Velocity spectrum relative to the theoretical H1 Spin-Flip frequency.

Using an On-Line Local Standard of Rest Velocity Calculator, create an hour-by-hour LSR velocity data correction table.

With Excel, fit a 2nd order equation and use within Matlab to create a set of LSR corrected Red Shift data.

**Local Standard of Rest Velocity Correction**

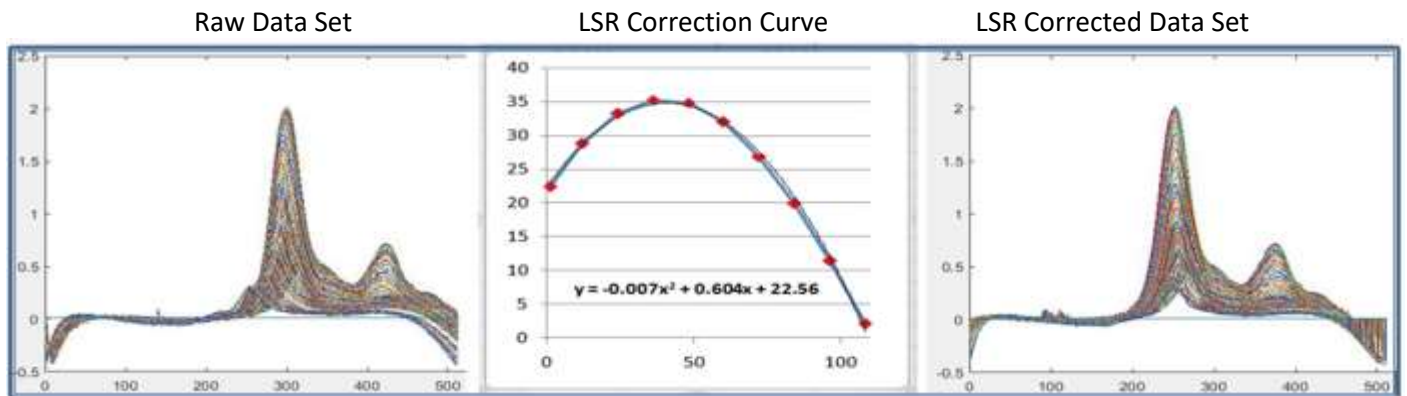

Results: A Spectral Velocity Analysis Graph of the 8-hour 100 sample data set using Matlab

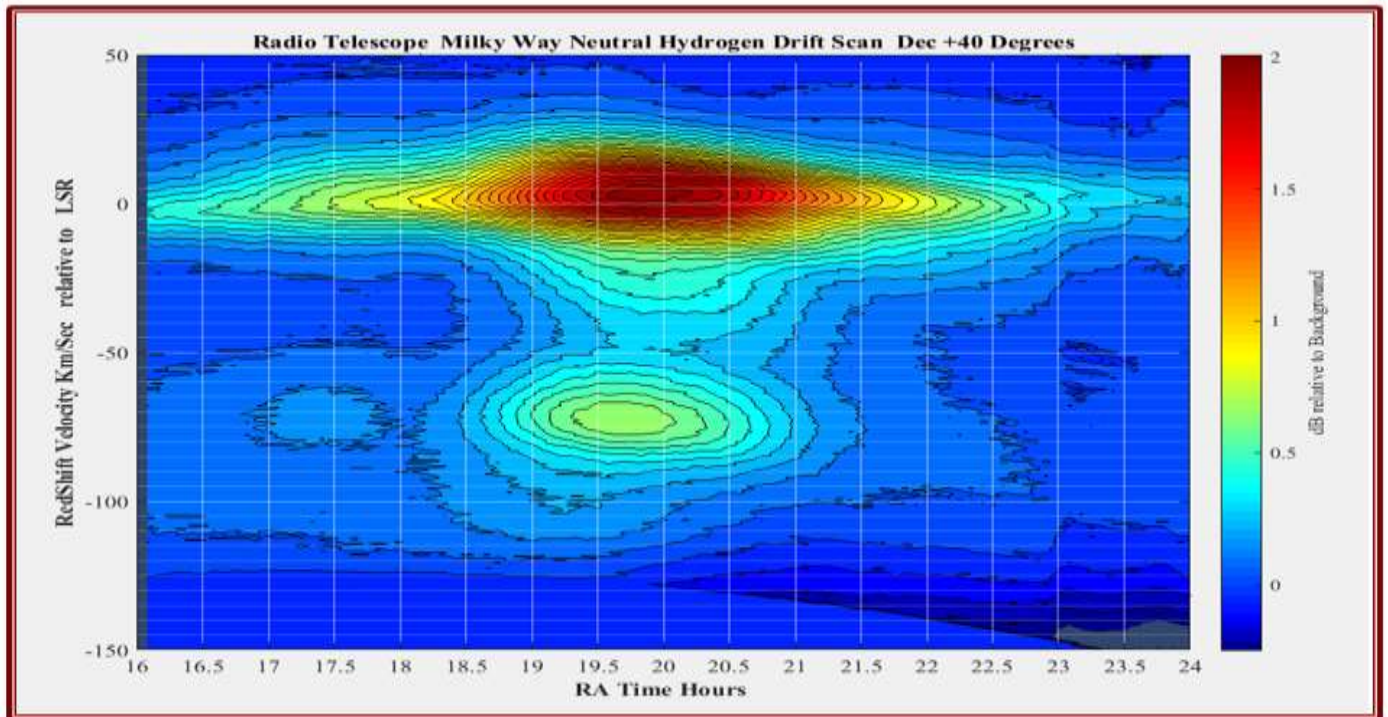

Accomplished using a lightweight, portable 'One Meter' Radio Telescope .

#### VLSR Calculator

<http://f4klo.ampr.org/vlsrKLO.php>

#### OM6AA Loop\_Feed Antenna

[http://om6aa.eu/Loop\\_Feed\\_with\\_enhanced\\_performance.pdf](http://om6aa.eu/Loop_Feed_with_enhanced_performance.pdf)

#### WD5AGO LNA / CavityFilter / WB Amp

<https://www.radioastronomysupplies.com>

**Solar Radio Observations at Anchorage, Coho and HAARP Radio Observatories**  
**Whitham D. Reeve & Christian Monstein**

Observations shown in chronological order. See Instrumentation section for additional details on the equipment, and Resources section for more detailed explanations of the phenomena. See also Acknowledgements section.

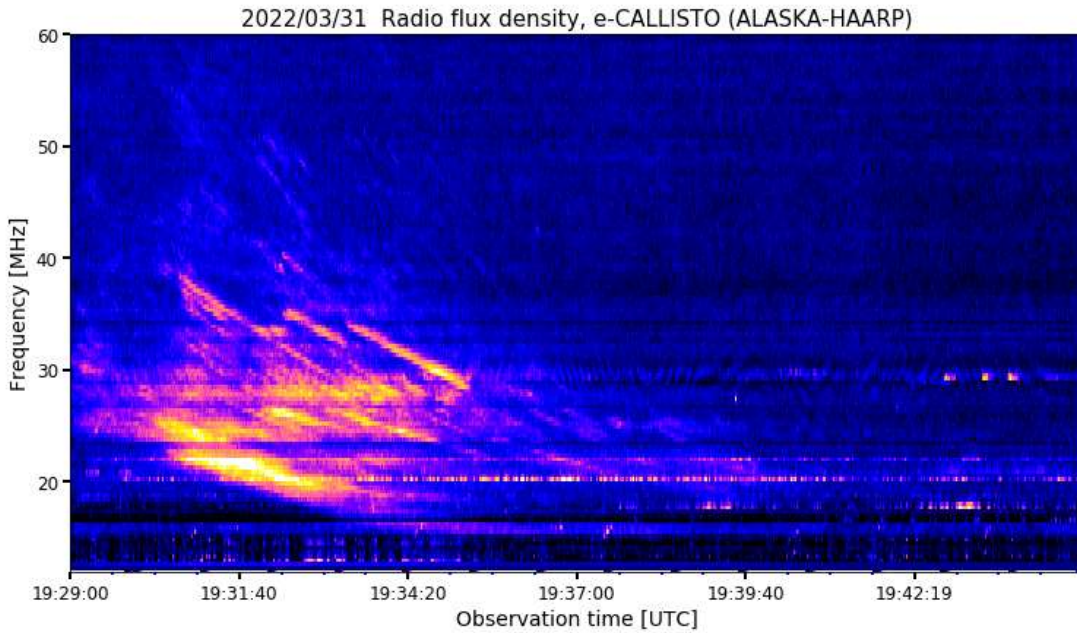

31 March 2022  
(left) ~ HAARP  
Radio  
Observatory,  
Gakona, Alaska:  
Type II slow  
sweep radio  
bursts caused by  
solar active  
region 2981 and  
may be related  
to a C5.4 x-ray  
flare as reported  
by SWPC.

30 April 2022 (below) ~ HAARP Radio Observatory, Gakona, Alaska: Annotated image. Type V continuum, Type II slow sweep, and Type III fast sweep radio bursts caused by M1.9 x-ray flare at solar active region 2994 as reported by SWPC. Note that the Type V burst extends down to 12 MHz, which is the low frequency limit of this spectrogram, and that the Type II burst may have a 3<sup>rd</sup> harmonic in addition to the fundamental and 2<sup>nd</sup> harmonic.

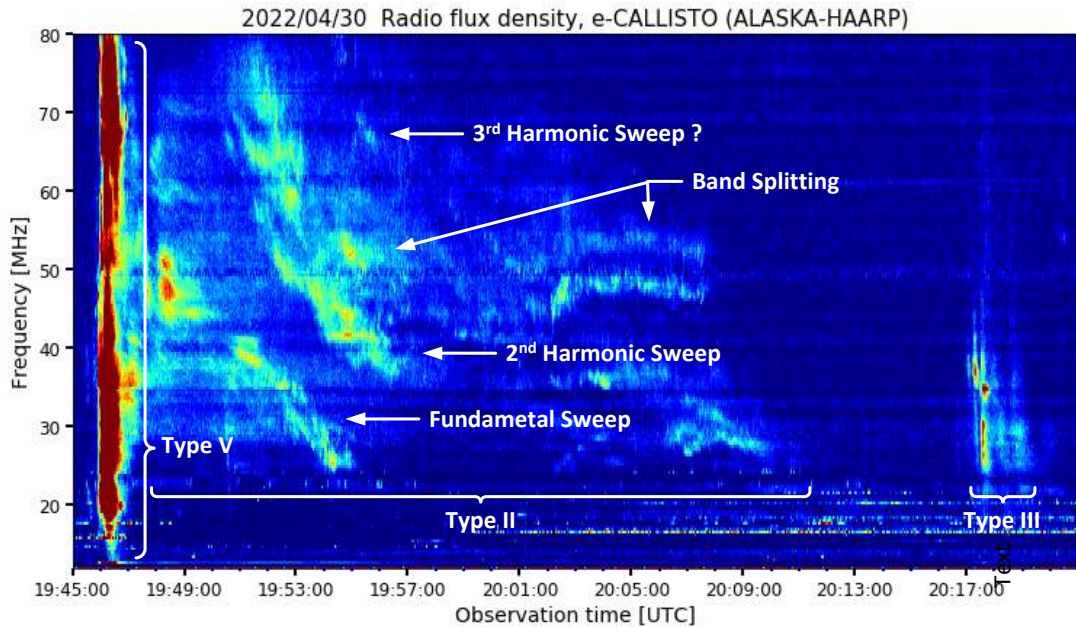

11 May 2022 (below) ~ HAARP Radio Observatory, Gakona, Alaska: Type II slow sweep radio burst caused by M2.6 flare at solar active region 3007 as reported by SWPC. The activity between 1900 and 1910 may be a second burst overlapping the first one or corruption of the first burst. Note that the spectra around 1906 extends down to 13 MHz, the lower limit of this spectrogram.

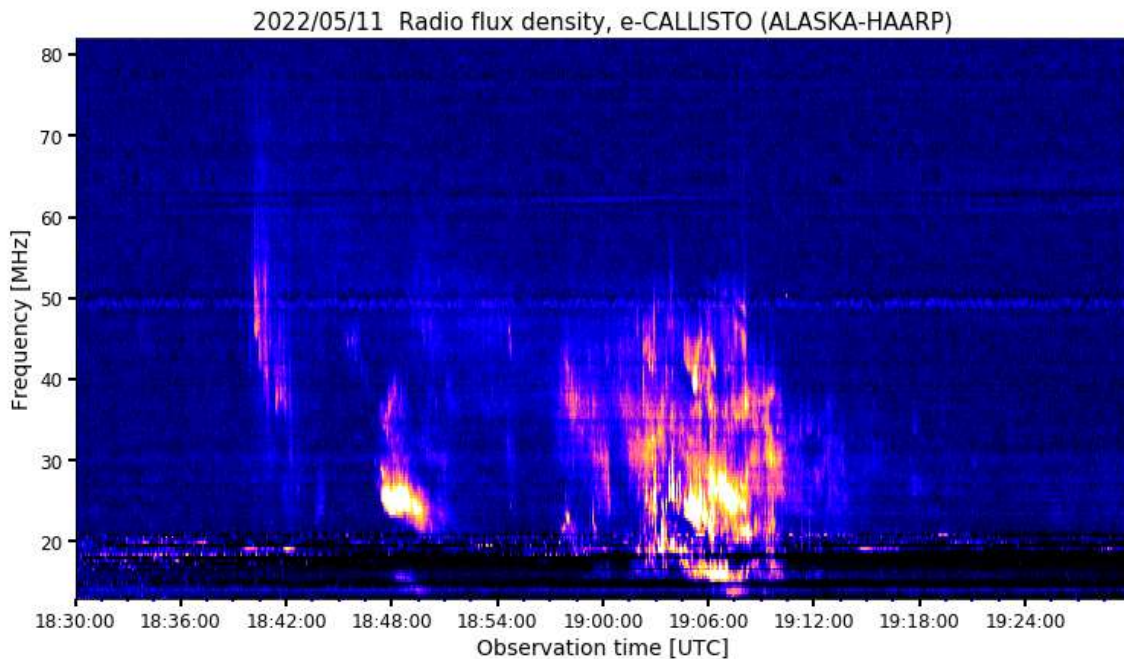

20 May 2022 (below) ~ HAARP Radio Observatory, Gakona, Alaska: Very weak u-shaped spectral indication of unknown origin. This may be an inverted-U solar radio burst or spectral caustics. Note that the frequency scale (right side of image) is reversed compared to other spectrograms in this report.

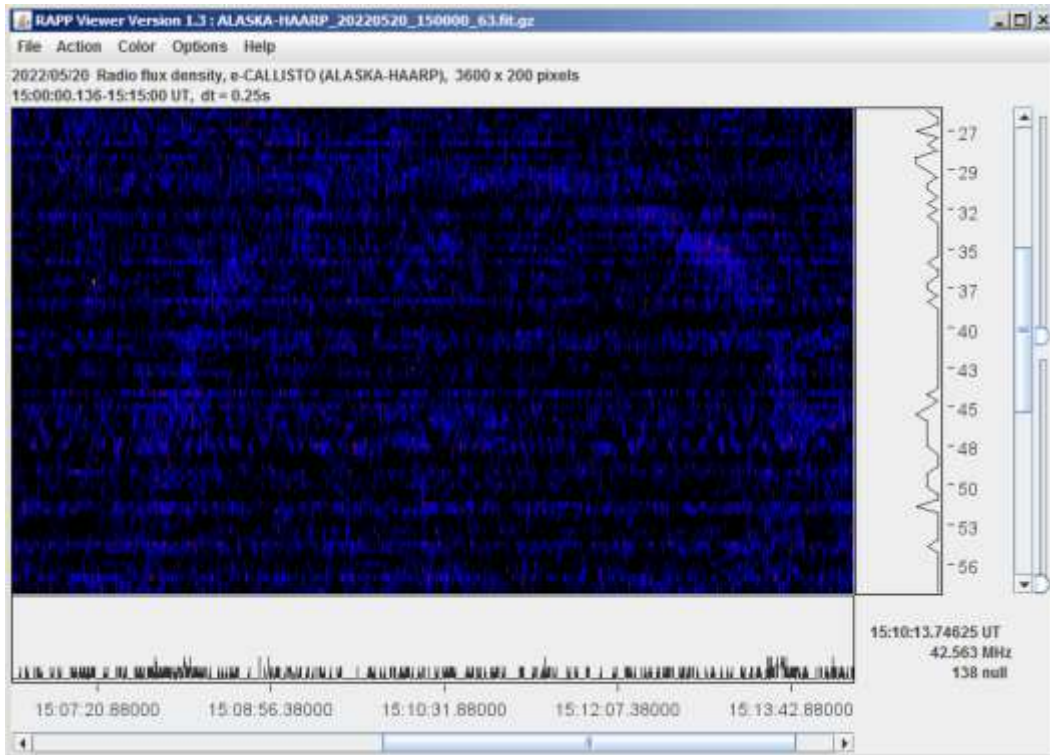

25 May 2022 (below) ~ HAARP Radio Observatory, Gakona, Alaska and Cohoe Radio Observatory, Cohoe, Alaska: Type II slow sweep radio bursts observed simultaneously at Cohoe and HAARP in right-hand and left-hand circular polarizations caused by M1.3 x-ray flare at solar active region 3016 as reported by SWPC. The first is from about 1818 to 1819 with a 2<sup>nd</sup> harmonic. The second burst overlaps the first slightly and also shows a 2<sup>nd</sup> harmonic.

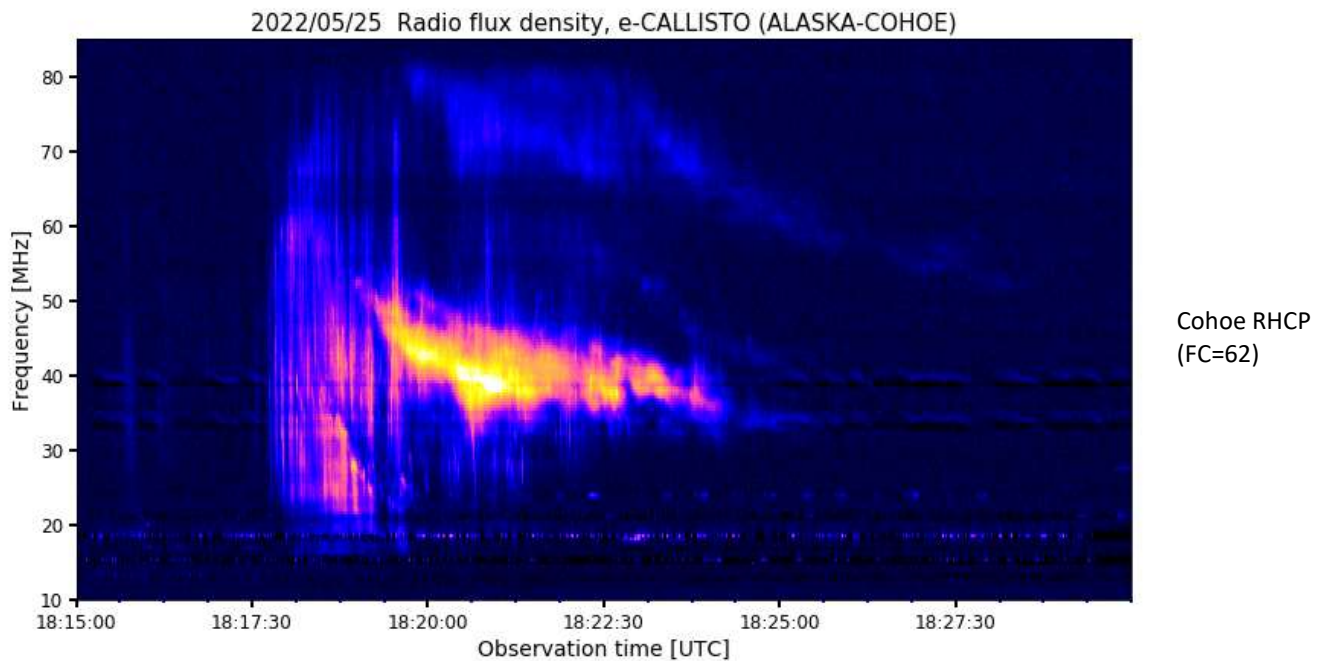

2022/05/25 Radio flux density, e-CALLISTO (ALASKA-COHOE)

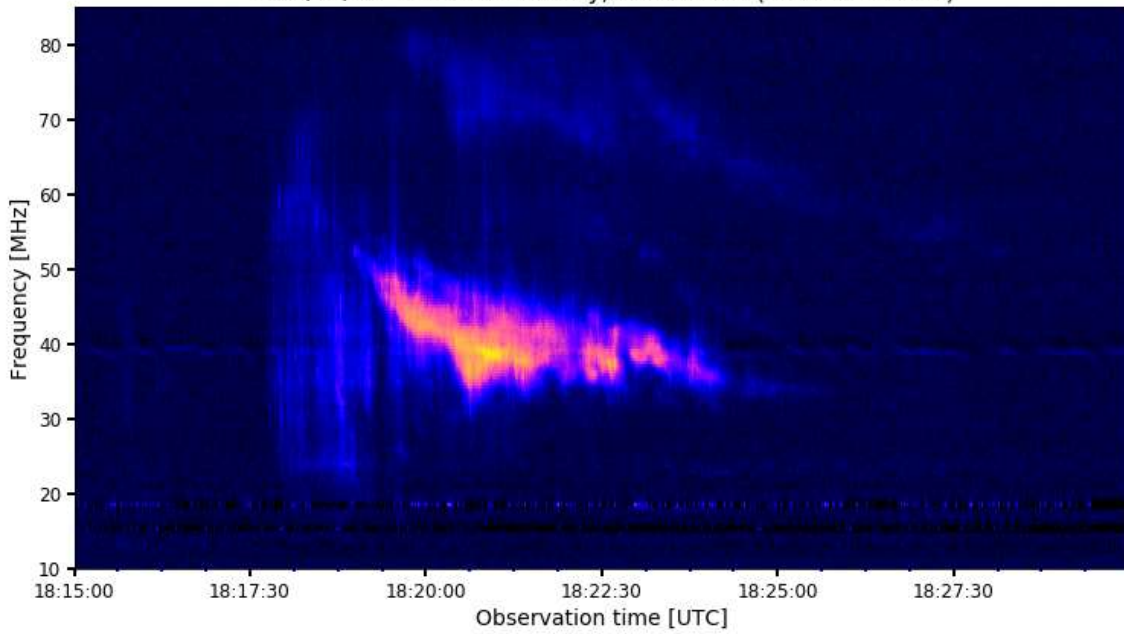

Cohoe LHCP  
(FC=63)

2022/05/25 Radio flux density, e-CALLISTO (ALASKA-HAARP)

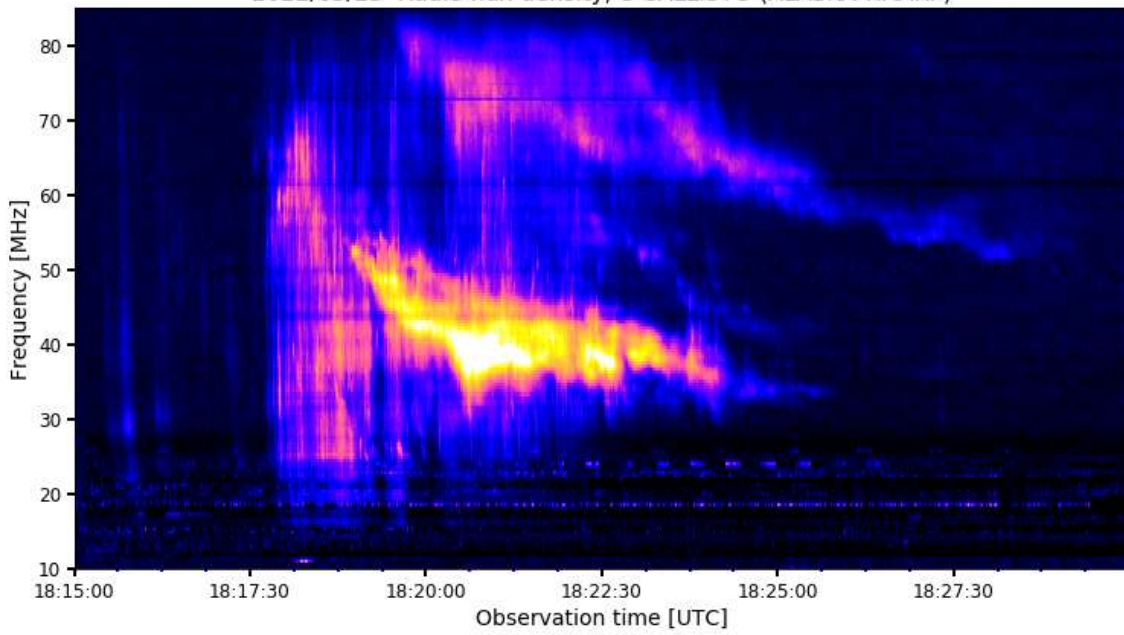

HAARP  
RHCP  
(FC=62)

2022/05/25 Radio flux density, e-CALLISTO (ALASKA-HAARP)

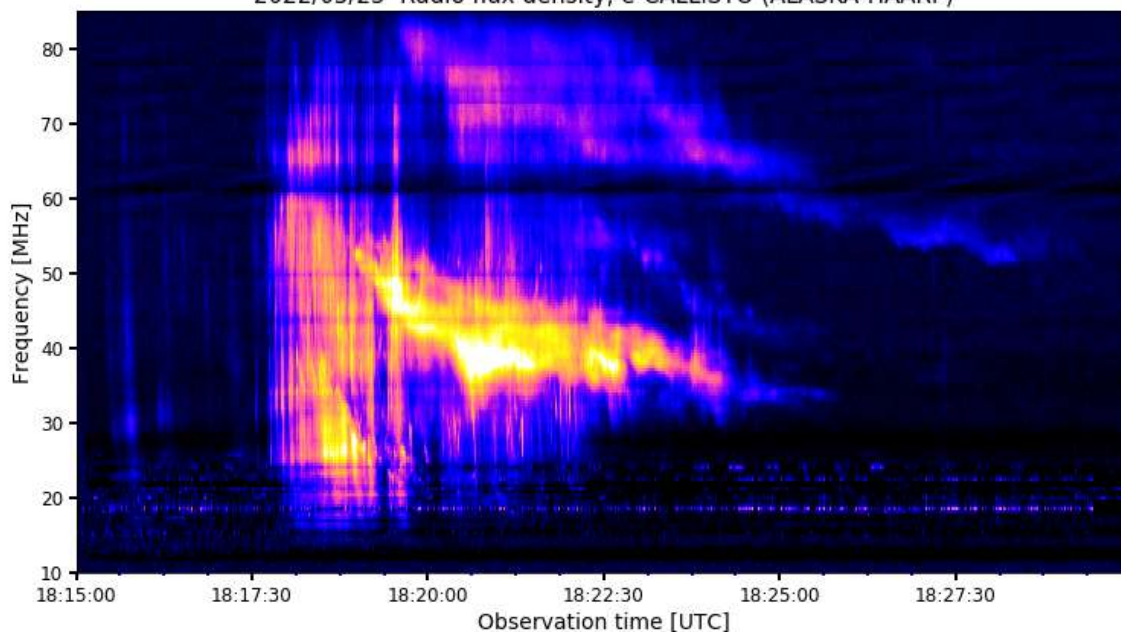

HAARP  
LHCP  
(FC=63)



HAARP Radio Observatory, Gakona, Alaska. LWA Antenna buried in the snow with a background of black spruce trees on 29 March 2022. The HRO equipment is collocated on the science pad with the Modular UHF Incoherent Radar (MUIR). Image courtesy of HAARP staff.



#### Instrumentation:

- ⚙ Anchorage Radio Observatory: 8-element log periodic dipole array and three Icom R-8600 wideband receivers with audio output connected through an analog audio mixer to a PC soundcard, SAM-III Magnetometer;
- ⚙ Coho Radio Observatory: LWA Antenna connected to two Callisto instruments through a quadrature coupler;
- ⚙ HAARP Radio Observatory: LWA Antenna connected to two Callisto instruments through a quadrature coupler.

#### Resources:

Solar radio burst types: <https://reeve.com/Solar/Solar.htm>

Type II Slow Sweep Radio Bursts: [https://www.reeve.com/Documents/CALLISTO/Reeve\\_TypeII-Burst.pdf](https://www.reeve.com/Documents/CALLISTO/Reeve_TypeII-Burst.pdf)

Sudden Frequency Deviations:

[https://www.reeve.com/Documents/Articles%20Papers/Propagation%20Anomalies/Reeve\\_SuddenFreqDevConcepts\\_P1.pdf](https://www.reeve.com/Documents/Articles%20Papers/Propagation%20Anomalies/Reeve_SuddenFreqDevConcepts_P1.pdf)

U-Burst: [https://www.reeve.com/Documents/Articles%20Papers/ReeveMonstein\\_U-Burst.pdf](https://www.reeve.com/Documents/Articles%20Papers/ReeveMonstein_U-Burst.pdf)

Space Weather Prediction Center: <https://www.swpc.noaa.gov/>

#### Acknowledgements:

Callisto FITS files, credit: FHNW Brugg/Windisch and IRSOL Locarno, Switzerland, {[Callisto](#)}

### Portable Antenna Mast Hold Down Notes:

Looking for way to hold down portable antennas?

Here is an image of 16 inch Trampoline Wind Stakes next to the antenna mast it will be holding down.



These are available from a number of locations, on Amazon search for the following; "AAGUT 16 Inch Trampolines Wind Stakes"

James Van Prooyen  
Grand Rapids Radio Observatory [gro@sbcglobal.net](mailto:gro@sbcglobal.net)

# Dual Radio Jove FRB Detection System Tests

James Van Prooyen

Grand Rapids Radio Observatory

This is a signal report or may be lack of one...

Testing of the Dual Radio Jove Receivers system for the detection of FRB, has started, and some of the data looked very good, shown below is the Radio Jove Receiver tuned to the high end of the 300 kHz pass band of the Version 1 Radio Jove type receiver.

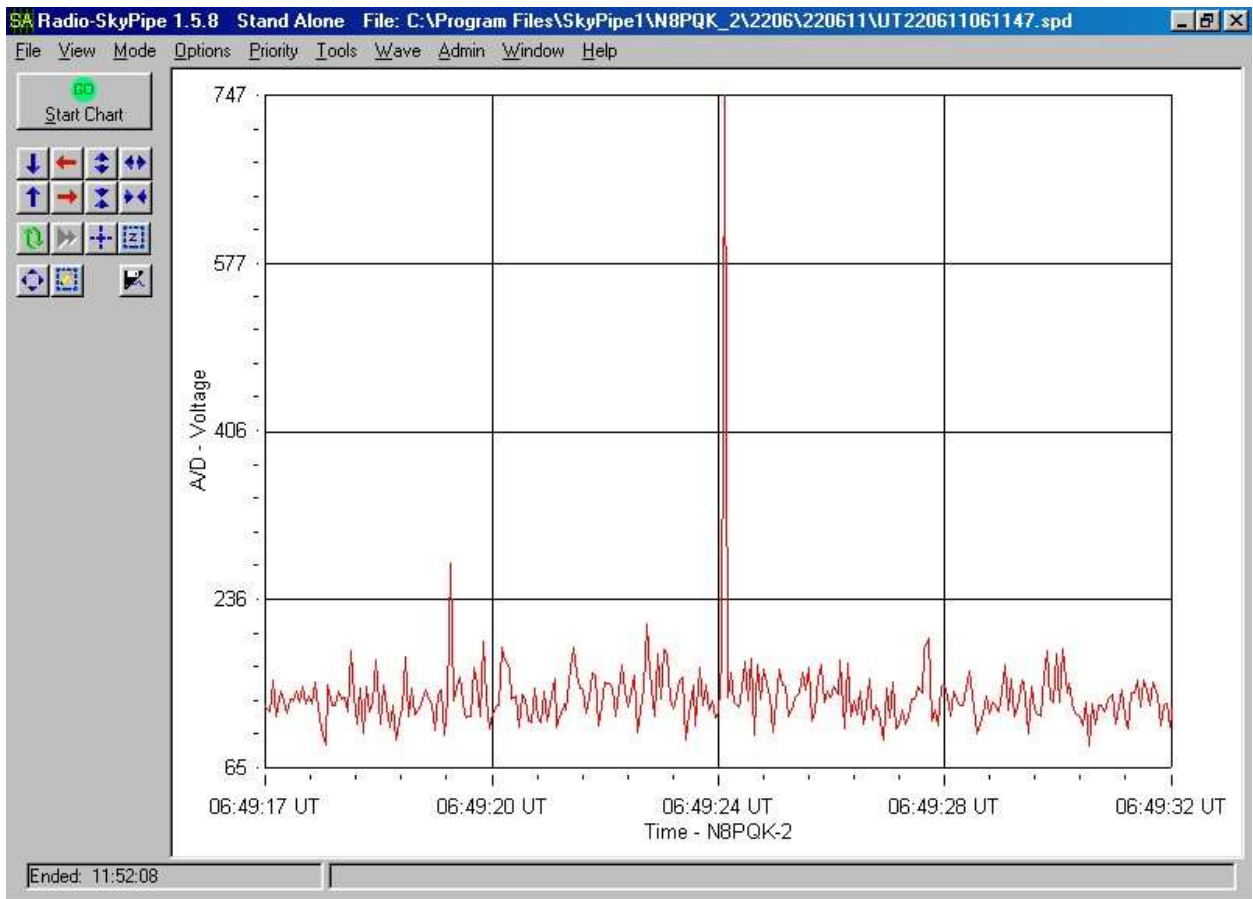

Wow! It looks like we may have detected something...

Well...

Looking at the Radio Jove receiver tuned to the low end of the band (~ 300 kHz difference) we see the following for the same time period.

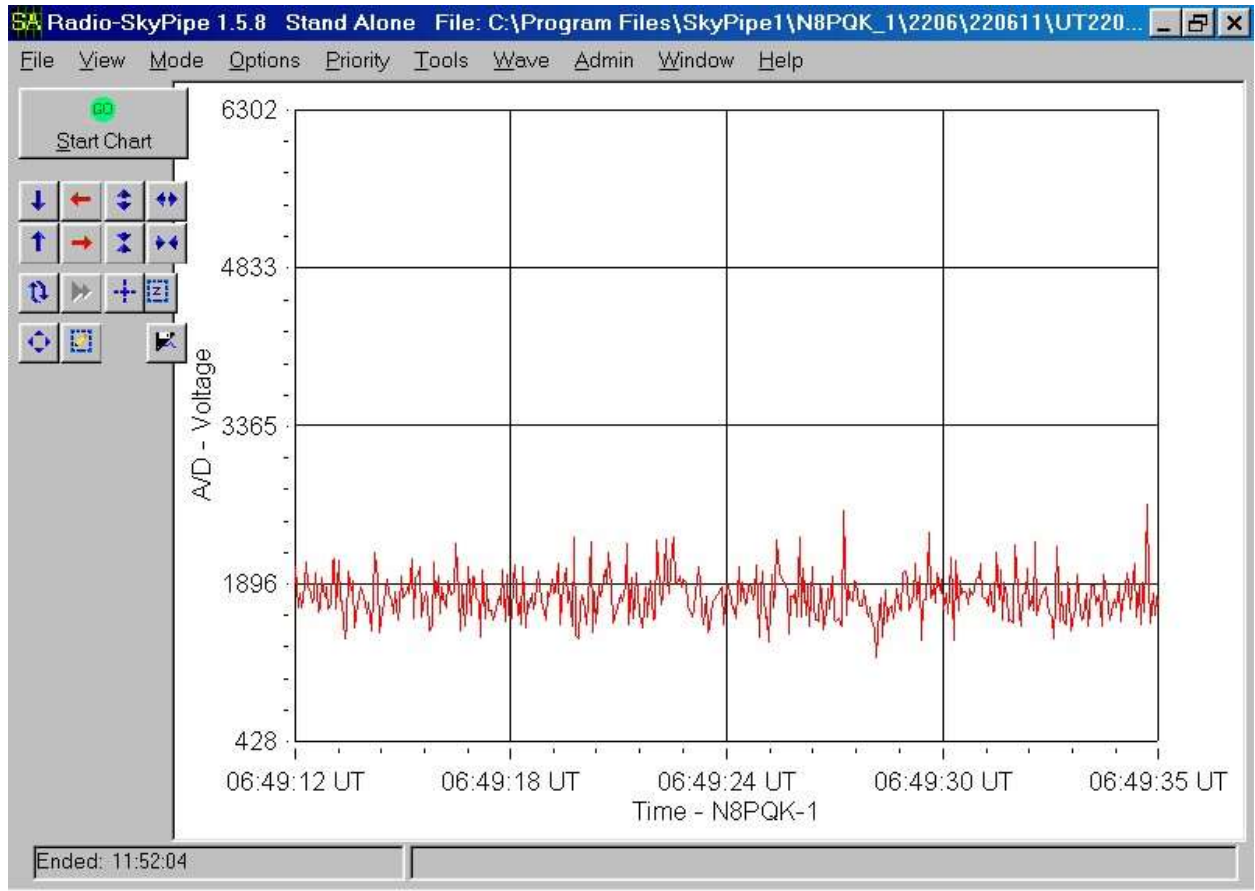

If this signal had been produced by an astronomical event we should have seen it on both receivers.

This was a failure to detect a FRB, but it was a success in that the dual band system allows us to filter out what could be a manmade signal from a possible FRB.

Now I do not know if FRB's can even be detected at such a low frequency, but the search fun and a good technology challenged.

#### Background Info:

The system is made up of 2 Radio Jove Version 1 receivers, each connected to a detector box. The detectors are in turn connected to an A/D (MAX 187). The A/D's are each connected to a PC's running Radio Sky Pipe. Note these are older PC's and an older version of Radio Sky Pipe but it does the job very well.

James Van Prooyen  
 Grand Rapids Radio Observatory [grro@sbcglobal.net](mailto:grro@sbcglobal.net)

## Membership

### New Members

Please welcome our new or returning SARA members who have joined since the last journal. If your name is missing or misspelled, please send an email to [treas@radio-astronomy.org](mailto:treas@radio-astronomy.org). We will make sure it appears correctly in the next Journal issue.

First name	Last name	City	State	Country	Call Sign
Sarah	Brown (Life member)	Silver Spring	MD	USA	KA3GMC
Catherine	Cullen	Union	WA	USA	
Winslow	Farrell	Easton	CT	USA	KC1OAJ
Bultman	T	Fairfax	VA	USA	
Tagliamonte	Paul	Washington	DC	USA	K3XEC
Lamoreaux	Bruce	Dacono	CO	USA	
Richard	Burrows	Trowbridge	Wiltshire	UK	
Thomas	Consi	Watertown	MA	USA	
Anthony	Emanuele	Painesville	OH	USA	K8ZR
Franklin	Smith	Milford	NH	USA	WS1MH
John	Kneen	Plano	TX	USA	

Membership dues are \$20.00 US per year and all dues expire in June. Student memberships are \$5.00 US per year. Memberships must be renewed in June of each year. Or pay once and never worry about missing your dues again with the SARA Life Membership. SARA Life Memberships are now offered for a one-time payment of twenty times the basic annual membership fee (currently \$400 US).

### Journal Archives & Other Promotions

The rich and diverse legacy of member contributed content is available in the SARA Journal Archives. Table of contents for journals is available online at [radio-astronomy.org/store](http://radio-astronomy.org/store).

The entire set of The Journal of The Society of Amateur Radio Astronomers is available on USB drive. It goes from the beginning of 1981 to the end of 2017 (over 6000 pages of SARA history!) Or you can choose one of the following USB drive's or DVD:\* (Prices are US dollars and include postage.)

†All SARA journals and conference proceedings are available through the previous calendar year.

Prices, US dollars, including postage

Members

Each USB drive	\$15.00
USB drive + 1-year membership extension	\$30.00

Non-members

Each USB drive	\$25.00
USB drive + 1-year membership	\$30.00

Non-USA members

Each USB drive \$20.00 (airmail)  
 USB drive+ 1-year members extension \$35.00

\*Already a member and want any or all these USB drives or DVD's? Buy any one for \$15.00 or get any three for \$35.00.

SARA Store ([radio-astronomy.org/store](http://radio-astronomy.org/store).)

SARA offers the above USB drives, DVDs, printed Proceedings and Proceedings on USB drive and other items at the SARA Store: <http://www.radio-astronomy.org/e-store>. Proceeds from sales go to support the student grant program. Members receive an additional 10% discount on orders over \$50 US. Payments can be made by sending payment by PayPal to [treas@radio-astronomy.org](mailto:treas@radio-astronomy.org) or by mailing a check or money order to SARA, c/o Brian O'Rourke, 337 Meadow Ridge Rd, Troy, VA 22974-3256

**SARA Online Discussion Group**

SARA members participate in the online forum at <http://groups.google.com/group/sara-list>. This is an invaluable resource for any amateur radio astronomer.

**SARA Conferences**

SARA organizes multiple conferences each year. Participants give talks, share ideas, attend seminars, and get hands-on experience. For more information, visit <http://www.radio-astronomy.org/meetings>.

**Facebook**

Like SARA on Facebook

<http://www.facebook.com/pages/Society-of-Amateur-Radio-Astronomers/128085007262843>

**Twitter**

Follow SARA on Twitter@RadioAstronomy1

**What is Radio Astronomy?**

This link is for a booklet explaining the basics of radio astronomy.  
<http://www.radio-astronomy.org/pdf/sara-beginner-booklet.pdf>

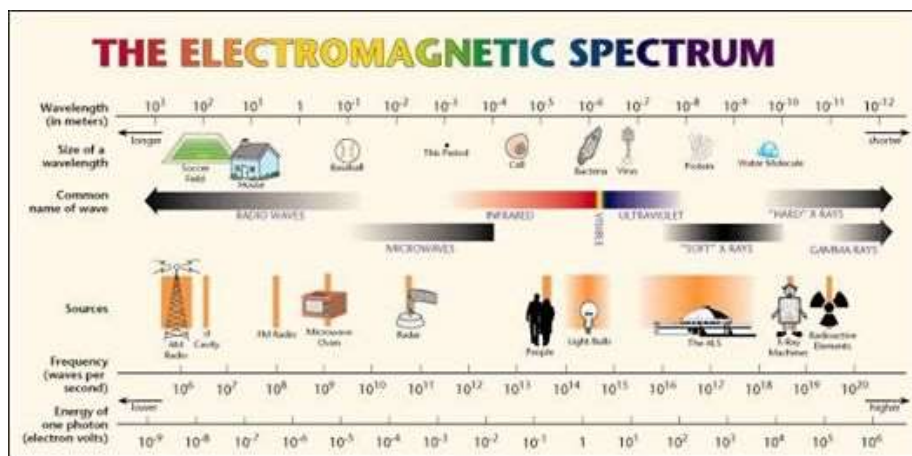

## Administrative

### Officers, directors, and additional SARA contacts

The Society of Amateur Radio Astronomers is an all-volunteer organization. The best way to reach people on this page is by email with SARA in the subject line SARA Officers.

President: Dennis Farr, WB4RJK, <https://www.radio-astronomy.org/contact/President> +1 813 833-3918

Vice President: Dr. Rich Russel, AC0UB <https://www.radio-astronomy.org/contact/Vicepresident>

Secretary: Bruce Randall, NT4RT, <https://www.radio-astronomy.org/contact/Secretary> +1 803-327-3325

Treasurer: Brian O'Rourke, K4UL, <https://www.radio-astronomy.org/contact/Treasurer>

Past President: Ken Redcap, [tbd@radio-astronomy.org](mailto:tbd@radio-astronomy.org) +1 319-591-1131

Founder Emeritus and Director: Jeffrey M. Lichtman, K14GIY, [jeff@radioastronomysupplies.com](mailto:jeff@radioastronomysupplies.com) +1 954-554-3739

### Board of Directors

Name	Term expires	Email
Ed Harfmann	2022	<a href="mailto:edharfmann@comcast.net">edharfmann@comcast.net</a>
Dr. Wolfgang Herrmann	2023	<a href="mailto:messbetrieb@astropeiler.de">messbetrieb@astropeiler.de</a>
Tom Jacobs	2023	<a href="mailto:tdj0@bellsouth.net">tdj0@bellsouth.net</a>
Charles Osborne	2023	<a href="mailto:k4cso@twc.com">k4cso@twc.com</a>
Keith Payea	2022	<a href="mailto:kbpayea@bryantlabs.net">kbpayea@bryantlabs.net</a>
Steve Tzikas	2022	<a href="mailto:Tzikas@alum.rpi.edu">Tzikas@alum.rpi.edu</a>
Jon Wallace	2023	<a href="mailto:wallacefj@comcast.net">wallacefj@comcast.net</a>
David Westman	2022	<a href="mailto:david.westman@engineeringretirees.org">david.westman@engineeringretirees.org</a>

### Other SARA Contacts

All Officers	<a href="http://www.radio-astronomy.org/contact-sara">http://www.radio-astronomy.org/contact-sara</a>	
All Directors and Officers	<a href="http://www.radio-astronomy.org/contact/All-Directors-and-Officers">http://www.radio-astronomy.org/contact/All-Directors-and-Officers</a>	
Eastern Conference Coordinator	<a href="http://www.radio-astronomy.org/contact/Annual-Meeting">http://www.radio-astronomy.org/contact/Annual-Meeting</a>	
All Radio Astronomy Editors	<a href="http://www.radio-astronomy.org/contact/Newsletter-Editor">http://www.radio-astronomy.org/contact/Newsletter-Editor</a>	
Radio Astronomy Editor	Dr. Richard A. Russel	<a href="mailto:drrichrussel@netscape.net">drrichrussel@netscape.net</a>
Contributing Editor	Whitham D. Reeve	<a href="mailto:whitreeve@gmail.com">whitreeve@gmail.com</a>
Educational Outreach	<a href="http://www.radio-astronomy.org/contact/Educational-Outreach">http://www.radio-astronomy.org/contact/Educational-Outreach</a>	
Grant Committee	Tom Crowley	<a href="mailto:grants@radio-astronomy.org">grants@radio-astronomy.org</a>
Membership Chair	<a href="http://www.radio-astronomy.org/contact/Membership-Chair">http://www.radio-astronomy.org/contact/Membership-Chair</a>	
Technical Queries (David Westman)	<a href="http://www.radio-astronomy.org/contact/Technical-Queries">http://www.radio-astronomy.org/contact/Technical-Queries</a>	
Webmaster	Ciprian (Chip) Sufitchi, N2YO	<a href="mailto:webmaster@radio-astronomy.org">webmaster@radio-astronomy.org</a>

## Resources

### Great Projects to Get Started in Radio Astronomy

#### Radio Observing Program

The Astronomical League (AL) is starting a radio astronomy observing program. If you observe one category, you get a Bronze certificate. Silver pin is two categories with one being personally built. Gold pin level is at least four categories. (Silver and Gold level require AL membership which many clubs have membership. For the bronze level, you need not be a member of AL.)

Categories include

- 1) SID
- 2) Sun (aka IBT)
- 3) Jupiter (aka Radio Jove)
- 4) Meteor back-scatter
- 5) Galactic radio sources

This program is a collaboration between NRAO and AL. Steve Boerner is the Lead Coordinator and a SARA member.

For more information:

Steve Boerner

2017 Lake Clay Drive

Chesterfield, MO 63017

Email: [sboerner@charter.net](mailto:sboerner@charter.net)

Phone: 636-537-2495

<http://www.astroleague.org/programs/radio-astronomy-observing-program>

#### Radio Jove



The Radio Jove Project monitors the storms of Jupiter, solar activity and the galactic background. The radio telescope can be purchased as a kit or you can order it assembled. They have a terrific user group you can join. <http://radiojove.gsfc.nasa.gov/>



## INSPIRE Program



The INSPIRE program uses build-it-yourself radio telescope kits to measure and record VLF emissions such as tweeks, whistlers, sferics, and chorus along with man-made emissions. This is a very portable unit that can be easily transported to remote sites for observations.

<http://theinspireproject.org/default.asp?contentID=27>

## SARA/Stanford SuperSID



Stanford Solar Center and the Society of Amateur Radio Astronomers have teamed up to produce and distribute the SuperSID (Sudden Ionospheric Disturbance) monitor. The monitor utilizes a simple pre-amp to magnify the VLF radio signals which are then fed into a high definition sound card. This design allows the user to monitor and record multiple frequencies simultaneously. The unit uses a compact 1-meter loop antenna that can be used indoors or outside. This is an ideal project for the radio astronomer that has limited space. To request a unit, send an e-mail to [supersid@radio-astronomy.org](mailto:supersid@radio-astronomy.org)

## Radio Astronomy Online Resources

AJ4CO Observatory – Radio Astronomy Website: <a href="http://www.aj4co.org/">http://www.aj4co.org/</a>	A New Radio Telescope for Mexico - ORION 2021 01 20. Dr. Stan Kurtz <a href="https://www.youtube.com/watch?v=Q9aBWr1aBVc">https://www.youtube.com/watch?v=Q9aBWr1aBVc</a>
Radio Astronomy calculators <a href="https://www.aj4co.org/Calculators/Calculators.html">https://www.aj4co.org/Calculators/Calculators.html</a>	National Radio Astronomy Observatory <a href="http://www.nrao.edu">http://www.nrao.edu</a>
Introduction to Amateur Radio Astronomy (presentation) <a href="http://www.aj4co.org/Publications/Intro%20to%20Amateur%20Radio%20Astronomy,%20Typinski%20(AAC,%202016)%20v2.pdf">http://www.aj4co.org/Publications/Intro%20to%20Amateur%20Radio%20Astronomy,%20Typinski%20(AAC,%202016)%20v2.pdf</a>	NRAO Essential Radio Astronomy Course <a href="http://www.cv.nrao.edu/course/ast534/ERA.shtml">http://www.cv.nrao.edu/course/ast534/ERA.shtml</a>
RF Associates Richard Flagg, rf@hawaii.rr.com 1721-1 Young Street, Honolulu, HI 96826	Exotic Ions and Molecules in Interstellar Space -- ORION 2020 10 21. Dr. Bob Compton <a href="https://www.youtube.com/watch?v=r6cKhp23SUo&amp;t=5s">https://www.youtube.com/watch?v=r6cKhp23SUo&amp;t=5s</a>
RFSpace, Inc. <a href="http://www.rfspace.com">http://www.rfspace.com</a>	The Radio JOVE Project & NASA Citizen Science – ORION 2020.6.17. Dr. Chuck Higgins <a href="https://www.youtube.com/watch?v=s6eWAXjywp8&amp;t=5s">https://www.youtube.com/watch?v=s6eWAXjywp8&amp;t=5s</a>
CALLISTO Receiver & e-CALLISTO <a href="http://www.reeve.com/Solar/e-CALLISTO/e-callisto.htm">http://www.reeve.com/Solar/e-CALLISTO/e-callisto.htm</a>	UK Radio Astronomy Association <a href="http://www.ukraa.com/">http://www.ukraa.com/</a>
Deep Space Exploration Society <a href="http://DSES.science">http://DSES.science</a>	CALLISTO software and data archive: <a href="http://www.e-callisto.org">www.e-callisto.org</a>
Deep Space Object Astrophotography Part 1 -- ORION 2021 02 17. George Sradnov <a href="https://www.youtube.com/watch?v=Pm_Rs17KlyQ">https://www.youtube.com/watch?v=Pm_Rs17KlyQ</a>	Radio Jove Spectrograph Users Group <a href="http://www.radiojove.org/SUG/">http://www.radiojove.org/SUG/</a>
European Radio Astronomy Club <a href="http://www.eracnet.org">http://www.eracnet.org</a>	Radio Sky Publishing <a href="http://radiosky.com">http://radiosky.com</a>
British Astronomical Association – Radio Astronomy Group <a href="http://www.britastro.org/baa/">http://www.britastro.org/baa/</a>	The Arecibo Radio Telescope; It's History, Collapse, and Future - ORION 2020.12.16. Dr. Stan Kurtz, Dr. David Fields <a href="https://www.youtube.com/watch?v=rBZPOLNX9E">https://www.youtube.com/watch?v=rBZPOLNX9E</a>
Forum and Discussion Group <a href="http://groups.google.com/group/sara-list">http://groups.google.com/group/sara-list</a>	Shirleys Bay Radio Astronomy Consortium <a href="mailto:marcus@propulsionpolymers.com">marcus@propulsionpolymers.com</a>
GNU Radio <a href="https://www.gnuradio.org/">https://www.gnuradio.org/</a>	SARA Twitter feed <a href="https://twitter.com/RadioAstronomy1">https://twitter.com/RadioAstronomy1</a>
SETI League <a href="http://www.setileague.org">http://www.setileague.org</a>	SARA Web Site <a href="http://radio-astronomy.org">http://radio-astronomy.org</a>
NRAO Essential Radio Astronomy Course <a href="http://www.cv.nrao.edu/course/ast534/ERA.shtml">http://www.cv.nrao.edu/course/ast534/ERA.shtml</a>	SARA Facebook page <a href="https://www.facebook.com/pages/Society-of-Amateur-Radio-Astronomers/128085007262843">https://www.facebook.com/pages/Society-of-Amateur-Radio-Astronomers/128085007262843</a>
NASA Radio JOVE Project <a href="http://radiojove.gsfc.nasa.gov">http://radiojove.gsfc.nasa.gov</a> Archive: <a href="http://radiojove.org/archive.html">http://radiojove.org/archive.html</a> <a href="https://groups.io/g/radio-jove">https://groups.io/g/radio-jove</a>	Simple Aurora Monitor: Magnetometer <a href="http://www.reeve.com/SAMDescription.htm">http://www.reeve.com/SAMDescription.htm</a>
National Radio Astronomy Observatory <a href="http://www.nrao.edu">http://www.nrao.edu</a>	Stanford Solar Center <a href="http://solar-center.stanford.edu/SID/">http://solar-center.stanford.edu/SID/</a>

## For Sale, Trade and Wanted

At the SARA online store: [radio-astronomy.org/store](http://radio-astronomy.org/store).

### SARA Polo Shirts

New SARA shirts have arrived.

We now have a good selection of X, XX, and XXX shirts available in all colors including white! Shirts are \$20 at the conference and \$25 shipped.

Contact the treasurer at [treas@radio-astronomy.org](mailto:treas@radio-astronomy.org) for availability and shipping.



### Scope in a Box \$295

[radio-astronomy.org/store](http://radio-astronomy.org/store).

Kit of parts and software to build a working Radio Telescope to detect Hydrogen Line emissions. Available to USA addresses only at this time.

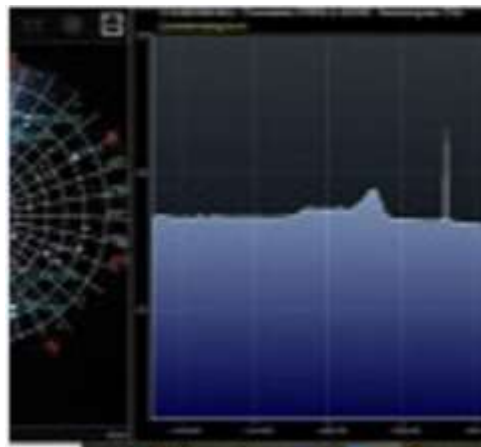

**SuperSID Complete Kit (\$112-\$160 depending on options)**

[radio-astronomy.org/store](http://radio-astronomy.org/store).



**SARA Publication, Journals and Conference Proceedings (various prices)**

[radio-astronomy.org/store](http://radio-astronomy.org/store).

**SARA Journal USB Drive (\$15-\$35 depending on shipping option)**

[radio-astronomy.org/store](http://radio-astronomy.org/store).

The USB drive covers the society journal "Radio Astronomy" from the founding of the organization in 1981 thru 2020. Articles cover a wide range of topics including: cosmic radiation, pulsars, quasars, meteor detection, solar observing, Jupiter, Radio Jove, gamma ray bursts, the Itty Bitty Telescope (IBT), dark matter, black holes, the Jansky antenna, methanol masers, mapping at 408 MHz and more. This CD contains all of the above and more with over 4800 pages of articles on radio astronomy. Also included is a copy of Grote Reber's handwritten, 34 page document "Carriage and Mirror Detail" of his historic antenna now on display at the National Radio Astronomy Observatory (NRAO) in Greenbank, WV. You also get an electronic copy of the 109 page "Basics of Radio Astronomy" from JPL Goldstone-Apple Valley Radio Telescope. Also included is the NRAO 40-foot radio telescope "Operators Manual", which by the way, you get to operate if you attend the Eastern SARA conference in July.

## SARA Advertisements

There is no charge to place an ad in Radio Astronomy; but you must be a current SARA member. Ads must be pertinent to radio astronomy and are subject to the editor's approval and alteration for brevity. Please send your "For Sale," "Trade," or "Wanted" ads to [edit@radio-astronomy.org](mailto:edit@radio-astronomy.org). Please include email and/or telephone contact information. Please keep your ad text to a reasonable length. Ads run for one bimonthly issue unless you request otherwise.

### **Radio-Astro-Machine, [zblac@gmail.com](mailto:zblac@gmail.com)**

Elevation rotation adapter plate for Scope in a Box and custom machining. For further information visit <https://radio-astro-machine.wixsite.com/my-site> or send an email.

### **Typinski Radio Astronomy, Inc., [info@typinski.com](mailto:info@typinski.com)**

Antenna systems and feed line components for HF radio astronomy

### **Jeff Kruth, WA3ZKR, [kmec@aol.com](mailto:kmec@aol.com)**

RF components from HF to MMW, various types including mixers, RF switches, amplifiers, oscillators, coaxial components, waveguide components, etc. I have a very large collection of stuff and the facilities to test and provide data. Please email with your needs and I will see if I have something for you. Have fun!

### **Stuart and Lorraine Rumley, [sales@valontechnology.com](mailto:sales@valontechnology.com)**

The Valon Technology 2100 Downconverter, when combined with our 5009 frequency synthesizer module, provides a high-performance, compact receiver downconverter system. Applications include hydrogen line studies at 1420MHz and radio astronomy in the protected 30MHz segment of the 21 cm band. For more information visit <http://www.valontechnology.com/2100downconverter.html> or send an email.

### **Radio2Space, [filippo.bradaschia@primalucelab.com](mailto:filippo.bradaschia@primalucelab.com)**

SPIDER radio telescopes and turn-key-systems designed specifically for education.

<https://www.radio2space.com>

We developed our SPIDER radio telescopes as turn-key-system just to avoid the problem you perfectly highlighted in your website: "Purchasing a radio telescope isn't like buying an optical telescope. They are harder to find, and usually require assembly and software troubleshooting. In some cases, a radio telescope must be built from components." Our SPIDER radio telescopes are not designed for amateurs that prefer to build a radio telescope but to schools, universities, museums, and other science institutes that needs for a complete and ready-to-use system, just like the optical telescopes they can normally buy!

### **Radio Astronomy Supplies**

<http://www.radioastronomysupplies.com>

[jeff@radioastronomysupplies.com](mailto:jeff@radioastronomysupplies.com)

Research and Educational Radio Telescopes and all associated equipment since 1994

**Membership Information**

Annual SARA dues Individual \$20, Classroom \$20, Student \$5 (US funds) anywhere in the world. Membership includes a subscription to Radio Astronomy, the bimonthly Journal of The Society of Amateur Radio Astronomers, delivered electronically (via a secure web link, emailed to you as each new issue is posted). We regret that printing and postage costs prevent SARA from providing hardcopy subscriptions to our Journal.

We would appreciate the following information included with your check or money order, made payable to SARA:

Name: \_\_\_\_\_  
 Email Address: \_\_\_\_\_  
(required for electronic journal delivery)  
 Ham call sign: \_\_\_\_\_ (if applicable)  
 Address: \_\_\_\_\_  
 City: \_\_\_\_\_  
 State: \_\_\_\_\_  
 Zip: \_\_\_\_\_  
 Country: \_\_\_\_\_  
 Phone: \_\_\_\_\_

Please include a note of your interests. Send your application for membership, along with your remittance, to our Treasurer.

For further information, see our website at: <http://radio-astronomy.org/membership>



**Society of Amateur Radio Astronomers, Inc.**  
 Founded 1981

Membership supported, nonprofit [501(c) (3)]  
 Educational and Radio Astronomy Organization  
**Knowledge through Common Research,  
 Education and Mentoring**

**How to get started?**

SARA has a made a kit of software and parts to detect the Hydrogen line signal from space. This is an excellent method to get started in radio astronomy. It teaches the principles of antenna design, signal detection, and signal processing. Read more about this and other projects on our web site.

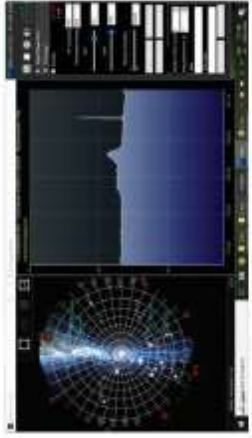

SARA members have been privileged to use this forty foot diameter drift-scan hydrogen line radio telescope every year at their annual meeting in Green Bank.



<http://radio-astronomy.org>

**Why Radio Astronomy?**

Because about sixty five percent of our current knowledge of the universe has stemmed from radio astronomy alone. The discovery of quasars, pulsars, black holes, the 3K background from the "Big Bang" and the discovery of biochemical hydrogen/carbon molecules are all the result of professional radio astronomy.

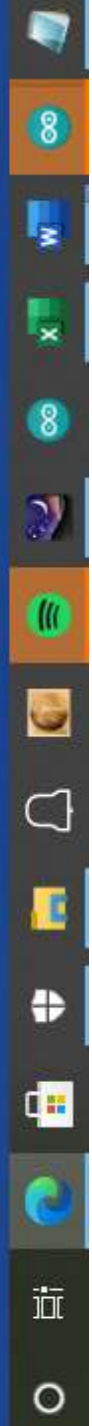

## The Society of Amateur Radio Astronomers

SARA was founded in 1981, with the purpose of educating those interested in pursuing amateur radio astronomy.

The society is open to all, wishing to participate with others, worldwide.

SARA members have many interests, some are as follows:

### SARA Areas of Study and Research:

- Solar Radio Astronomy
- Galactic Radio Astronomy
- Meteor Detection
- Jupiter
- SETI
- Gamma Ray/High Energy Pulse Detection
- Antennas
- Design of Hardware / Software

The members of the society offer a friendly mentor atmosphere. All questions and inquiries are answered in a constructive manner. No question is silly!

SARA offers its members an electronic bi-monthly journal entitled Radio Astronomy. Within the journal, members report on their research and observations. In addition, members receive updates on the professional radio astronomy community and, society news.

Once a year SARA meets for a three-day conference at the Green Bank Observatory in Green Bank West Va.

There is also a spring conference held at various cities in the Western USA. Previous meetings have been at the VLA in Socorro, NM and at Stanford University.



### How do amateurs do radio astronomy?

Radio astronomy by amateurs is conducted using antennas of various shapes and sizes, from smaller parabolic dishes to simple wire antennas. These antennas are connected to receivers and most of these receivers are software defined radios these days. Data from the receivers are collected by computers, and the received signals will be displayed as charts, graphs or maybe even sky maps. As diverse as the observed objects, so is the instruments and tools used. SARA members will always be supportive to find good solutions for what one wishes to observe.

### Is amateur radio astronomy instrumentation expensive?

Technical information freely circulated in our monthly journal helps amateurs to obtain good low noise equipment from off the shelf assemblies, or to build their own units. The actual cash investment in radio astronomy equipment need not exceed that of any other hobby.

### What are amateurs actually looking for in the received data?

The aim of the radio amateur is to find something new and unusual. Just as an amateur optical observer hopes to notice a supernova or a new comet, so does an amateur radio observer hope to notice a new radio source, or one whose radiation has changed appreciably.

### How do I get started?

Just as a long journey begins with the first step, the project you elect must start with a clear idea of your objectives. Do you wish to study the sun? Jupiter? Make meteor counts? Do you wish to engage in imaging radio astronomy? What you decide will not only determine the type of equipment you will need, but also the local radio spectrum.



The Reber Telescope at NRAO. Constructed by Grote Reber in 1937 in his back yard in Wheaton, Illinois



SARA Members discussing the IBT (Itty Bitty Telescope)

