

# RADIO ASTRONOMY

Journal of the Society of Amateur Radio Astronomers  
January – February 2022

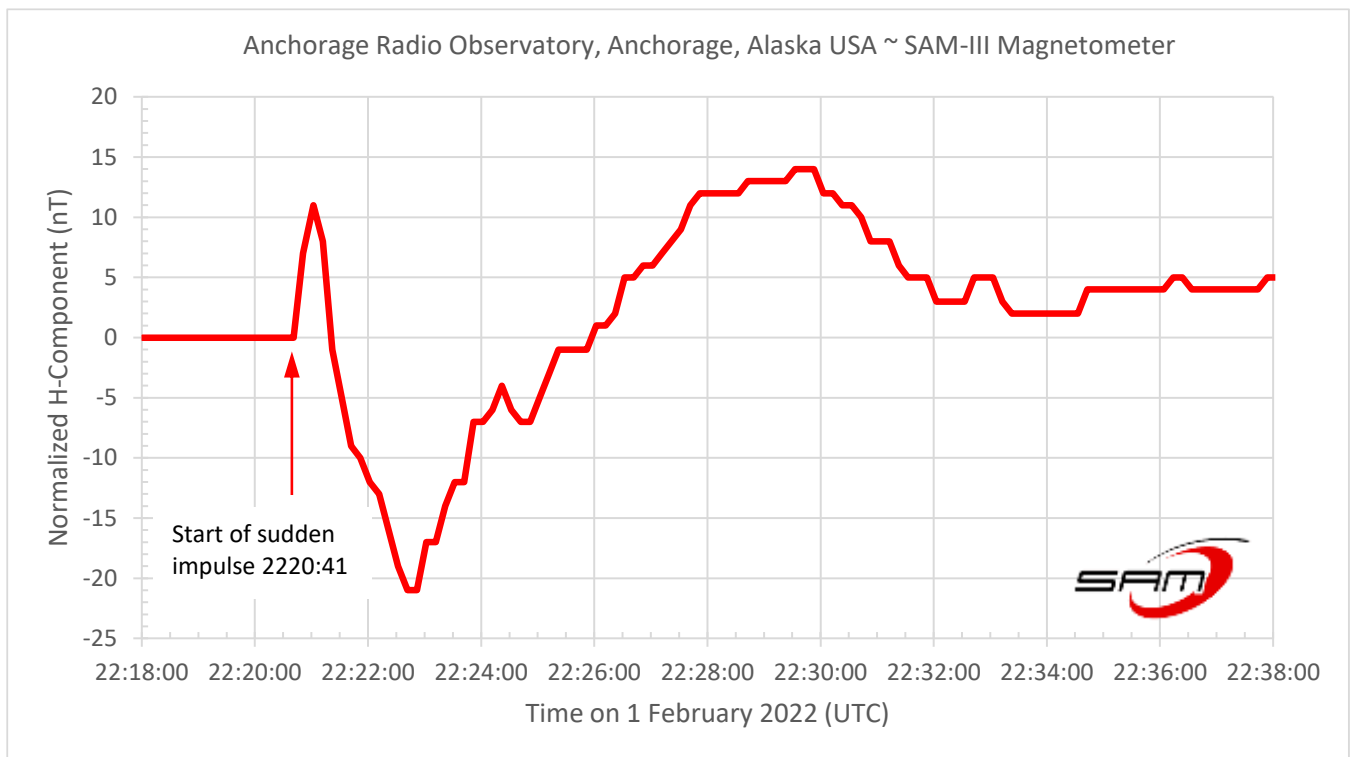

**Magnetometer Detection of February 1, 2022  
Coronal Mass Ejection**



**Dennis Farr**  
*SARA President*

**Dr. Richard A. Russel**  
*Editor*

**Whitham D. Reeve**  
*Contributing Editor*

Radio Astronomy is published bimonthly as the official journal of the Society of Amateur Radio Astronomers. Duplication of uncopyrighted material for educational purposes is permitted but credit shall be given to SARA and to the specific author. Copyrighted materials may not be copied without written permission from the copyright owner.

Radio Astronomy is available for download only by SARA members from the SARA web site and may not be posted anywhere else.

It is the mission of the Society of Amateur Radio Astronomers (SARA) to: Facilitate the flow of information pertinent to the field of Radio Astronomy among our members; Promote members to mentor newcomers to our hobby and share the excitement of radio astronomy with other interested persons and organizations; Promote individual and multi station observing programs; Encourage programs that enhance the technical abilities of our members to monitor cosmic radio signals, as well as to share and analyze such signals; Encourage educational programs within SARA and educational outreach initiatives. Founded in 1981, the Society of Amateur Radio Astronomers, Inc. is a membership supported, non-profit [501(c) (3)], educational and scientific corporation.

Copyright © 2022 by the Society of Amateur Radio Astronomers, Inc. All rights reserved.

Cover Photo: Whitham Reeve

## Contents

<b>Radio Waves</b> .....	2
President's Page .....	2
Editor's Notes .....	3
<b>SARA NOTES</b> .....	4
<b>News: (Jan-Feb 2022)</b> .....	10
<b>Technical Knowledge &amp; Education: (Jan-Feb 2022)</b> .....	12
<b>Announcements</b> .....	14
SuperSID .....	23
John Cook's VLF Report .....	26
BAA RA Section Summer programme 2022.....	43
<b>Feature Articles</b> .....	44
Getting the Best out of PRESTO - Part 4: Dispersion Search Discrimination .....	44
HAARP – Solar Orbiter Experiment.....	60
Low Frequency Observations of the 4 December 2021 Solar Eclipse .....	69
<b>Observation Reports</b> .....	81
Coronal Mass Ejection (CME) Causes Sudden Frequency Deviations (SFD) of $\pm 2$ Hz at 15 and 25 MHz.....	81
Meteor Detection - Peak of 2022 Quadrantids Meteor Shower .....	84
<b>Membership</b> .....	87
New Members .....	87
Journal Archives & Other Promotions .....	88
SARA Online Discussion Group .....	88
What is Radio Astronomy? .....	89
<b>Administrative</b> .....	89
Officers, directors, and additional SARA contacts.....	89
<b>Resources</b> .....	91
Great Projects to Get Started in Radio Astronomy .....	91
Radio Astronomy Online Resources .....	93
<b>For Sale, Trade and Wanted</b> .....	94
SARA Advertisements .....	96
SARA Brochure.....	97

## Radio Waves

### President's Page



I've recently been following Radio Astronomy Telescopes Around the World and In Space on Facebook.

There is a lot of stuff going on around the world that doesn't get to the casual amateur.

For example,

[https://www.bbc.co.uk/newsround/49046599?fbclid=IwAR1PZNbxX2Qfn6QgG4NJMsMj8VdD94SMT8biAC\\_OjrZf9gyAFdnCYk3N9Bc](https://www.bbc.co.uk/newsround/49046599?fbclid=IwAR1PZNbxX2Qfn6QgG4NJMsMj8VdD94SMT8biAC_OjrZf9gyAFdnCYk3N9Bc)

Lots coming up as the northern hemisphere begins to thaw out.

SARA spring conference held on ZOOM, Hamcation held in Orlando and I'm sure others I am not aware of. If you know of some, please take the time to mention on the SARA group email list.

Please take advantage of any shows or conferences in your area to learn more about our passion, radio astronomy. More importantly, offer to teach/present at those events.

Keep your antennas pointed up!

Dennis

**Editor’s Notes**

We are always looking for basic radio astronomy articles, radio astronomy tutorials, theoretical articles, application and construction articles, news pertinent to radio astronomy, profiles and interviews with amateur and professional radio astronomers, book reviews, puzzles (including word challenges, riddles, and crossword puzzles), anecdotes, expository on “bad astronomy,” articles on radio astronomy observations, suggestions for reprint of articles from past journals, book reviews and other publications, and announcements of radio astronomy star parties, meetings, and outreach activities.

***New Journal Feature – Observation Reports***

We are now accepting 1-2 page observation reports. These reports should include the astronomical objects RA/DEC plus UTC of the observation. Also include the telescope configuration, process used to observe the object and results. Picture of the setup and plots of the observation are a plus to the report.

If you would like to write an article for Radio Astronomy, please follow **the newly updated Author’s Guide** on the SARA web site:

[http://www.radio-astronomy.org/publicat/RA-JSARA\\_Author’s\\_Guide.pdf](http://www.radio-astronomy.org/publicat/RA-JSARA_Author’s_Guide.pdf).

Let us know if you have questions; we are glad to assist authors with their articles and papers and will not hesitate to work with you. You may contact your editors any time via email here: [edit@radio-astronomy.org](mailto:edit@radio-astronomy.org).

The editor(s) will acknowledge that they have received your submission within two days. If they do not reply, assume they did not receive it and please try again.

Please consider submitting your radio astronomy observations for publication: any object, any wavelength. Strip charts, spectrograms, magnetograms, meteor scatter records, space radar records, photographs; examples of radio frequency interference (RFI) are also welcome.

*Guidelines for submitting observations may be found here:* [http://www.radio-astronomy.org/publicat/RA-JSARA\\_Observation\\_Submission\\_Guide.pdf](http://www.radio-astronomy.org/publicat/RA-JSARA_Observation_Submission_Guide.pdf)

Issue	Articles	Review	Distribution
<b>2022</b>			
Mar-Apr	Apr 12	Apr 22	Apr 30
May-Jun	Jun 12	Jun 22	Jun 30
Jul-Aug	Aug 12	Aug 22	Aug 31
Sept-Oct	Oct 12	Oct 22	Oct 31
Nov-Dec	Dec 12	Dec 22	Dec 31

## **Virtual 2022 SARA Spring Conference to be held on April 16, 2022**

The 2022 SARA Spring Conference will be held on Zoom, April 16, 2022. This virtual conference will replace the annual SARA Western Conference because of the continuing COVID-19 pandemic.

Contact: Please contact conference coordinator Dave Westman if you have any questions about the conference or if you would like to help  
[westernconference@radio-astronomy.org](mailto:westernconference@radio-astronomy.org) . Website: [www.radio-astronomy.org](http://www.radio-astronomy.org)

Presentations and proceedings: Papers and presentations on radio astronomy hardware, software, education, research strategies, philosophy, and observing efforts and methods are welcome. The deadline for submitting a letter of intent to the conference coordinator including a proposed title and informal abstract or outline is 15 February 2022. Formal proceedings will be published electronically for this conference, and a link will be emailed to registered participants.

Registration: Registration for the 2022 Spring Conference is just US\$25.00. Attendees at the conference must be SARA members; if you are not yet a member, this will cost an additional \$20. Payment can be made from the SARA Store, (<https://www.radio-astronomy.org/store/> - please look for Spring Virtual Conference), or payment can be made by going to [www.paypal.com](http://www.paypal.com) and directing payment to [treas@radio-astronomy.org](mailto:treas@radio-astronomy.org). Please include in comments that the payment is for the 2022 Spring Conference. You also can mail a check to SARA Treasurer (Brian O'Rourke), 337 Meadow Ridge Rd, Troy, VA. 22974 . Please include an e-mail address so a confirmation can be sent to you upon receipt of payment.

### Call for papers: 2022 SARA Spring Conference Virtual on Zoom

The Society of Amateur Radio Astronomers (SARA) hereby solicits papers for presentation at its 2022 Spring Conference, to be held April 16, 2022 via Zoom. Papers on radio astronomy hardware, software, education, research strategies, observations and philosophy are welcome. SARA members or supporters wishing to present a paper should email a letter of intent, including a proposed title and informal abstract or outline to [westernconf@radio-astronomy.org](mailto:westernconf@radio-astronomy.org) no later than 15 February 2022 (please let us know if you require more time). Be sure to include your full name, affiliation, postal address, and email address, and indicate your willingness to participate in the conference to present your paper. Submitters will receive an email response, typically within one week. Formal printed Proceedings will be published electronically for this conference and a link will be sent to each participant prior to the conference. Website: [www.radio-astronomy.org](http://www.radio-astronomy.org)



Dr. Darcy Barron  
Keynote Speaker  
SARA 2022 Spring Conference

I am pleased to announce that Dr. Darcy Barron, Assistant Professor, Dept. of Physics and Astronomy, University of New Mexico, has agreed to give the keynote speech at the 2022 SARA Spring Conference on April 16, 2022. Prior to joining the department at UNM, Dr. Barron was a National Science Foundation Astronomy and Astrophysics Postdoctoral Fellow and Charles H. Townes Postdoctoral Fellow at the Space Sciences Lab at University of California, Berkeley. Dr. Barron received her PhD in Physics from the University of California, San Diego in 2015, advised by Prof. Brian Keating.

An active member of the international POLARBEAR, Simons Observatory, and CMB-S4 collaborations, Dr. Barron is passionate about cosmology and instrumentation. Her current research focuses on precision measurements of the cosmic microwave background (CMB), including building instruments to study the faint divergence-free polarization pattern known as B-mode polarization. Detailed characterization of the CMB will further our understanding of the components of the universe and its large-scale structure.

When she's not working, she can be found exploring the deserts and mountains of New Mexico by foot, bicycle, and plane. She also appreciates the longer wavelengths of the electromagnetic spectrum and is a licensed amateur radio operator.

#### Honors

Women in STEM award from ADVANCE at UNM, 2019

NSF Astronomy and Astrophysics Postdoctoral Fellow, 2015 - 2018

Charles H. Townes Fellow at Space Sciences Laboratory, UC Berkeley, 2015-2018

Second inductee to Spring Valley C.C.S.D. Foundation Honors Hall of Fame, 2020

## SARA 2022 Spring Conference

April 16, 2021, Virtual

### Conference Schedule

Time (PDT) [UTC]	Activity/Title	Presenter
<b>Saturday, April 16th</b>		
9:00 – 9:15 [16:00]	Introductions, etc.	Dennis Farr, David Westman
9:15 – 10:00 [16:15]	Keynote Speech	Darcy Barron, UNM
10:00 – 10:45 [17:00]	HF Aurora Reflections Observed at Anchorage, Alaska USA	Whitham Reeve
10:45 – 11:00 [17:45]	Break	
11:00 – 11:45 [18:00]	Space Navigation: Determining Intergalactic Spacecraft Drag from Fast Radio Burst and Pulsar Detections	Richard Russel
11:45 – 1:00 [19:00]	Lunch Break	
1:00 – 1:45 [20:00]	Observation of the Magnetar XTE J1810-197	Wolfgang Hermann
1:45 – 2:30 [20:45]	Amateur-scale Instrumentation for FRB Observations	Marcus Leech (CCERA)
2:30 – 2:45 [21:30]	Break	
2:45 – 3:30 [21:45]	A multi wavelength Extremely High Frequency Imaging Solar Radio Telescope Or How I learned to love my spectroheliograph	David Iadevaia
3:30 – 4:15 [22:30]	Faster Processing Techniques for Small Aperture Pulsar Detections	Peter East
4:30 [23:30]	Closing Remarks	David Westman

## **SARA 2022 Spring Conference Abstracts**

### **HF Aurora Reflections Observed at Anchorage, Alaska USA**

Whitham D. Reeve

Many interesting phenomena can be observed in the high frequency radio band including aurora reflections, meteor trail reflections, radio blackouts, sudden frequency deviations, aircraft reflections, and propagation anomalies due to ionospheric patches and blobs. Detections of all these phenomena at Anchorage involve a terrestrial transmitter and terrestrial receiver separated by a distance great enough to result in sky wave propagation between them.

The focus of this paper is aurora reflections. The terms radio aurora, aurora scattering, aurora echoes, aurora radio reflections and aurora reflections are used interchangeably to describe transmissions that originate at a distant transmitter, are reflected by high-electron-density regions associated with the aurora, and are detected by a receiver as a form of bistatic radar. The transmissions originate at the WWV and WWVH time-frequency stations approximately 4000 km away, and the reflections are thought to occur 500 to 1000 km north of Anchorage, where they are detected by a receiver.

This paper follows up the paper presented at the SARA 2021 Eastern Conference on HF meteor trail reflections and includes an overview of early investigations and concepts that underly the observations of aurora reflections, instrumentation, and a selection of spectrum images from 2020 showing aurora reflections.

### **Observation of the Magnetar XTE J1810-197**

Wolfgang Hermann (EUCARA)

Magnetars are exotic neutron stars, and only few are observable as radio sources. The Magnetar XTE J18019-197 has been observed with high cadence with the Astropeler Stockert 25-m dish since it became radio bright (again) in December 2020. We report on the results of this observation campaign, describing how the source has evolved over time. In particular, the occurrence of very bright single pulses will be highlighted.

### **Intergalactic Space Navigation: Determining Intergalactic Spacecraft Drag from Fast Radio Burst and Pulsar Detections**

Richard A. Russel

This paper explores the use of dispersion measure from Fast Radio Bursts (FRB) and pulsars to determine the electron density in the space column between Earth and the measured object. The electron density measurements can be mapped to the galaxy using pulsars and intergalactic space using FRBs. Electron density can provide a relative drag calculation when paired with a hypothetical intergalactic spaceship with known drag characteristics. For the space navigator, this leads to the determination of the best path through the least dense areas of space and hence higher speed from a given spacecraft thrust.



## **Amateur-scale Instrumentation for FRB Observations**

Marcus Leech

Canadian Centre for Experimental Radio Astronomy

The success of the STARE2 project in detecting an FRB-like outburst from a galactic magnetar, SGR1935+215, suggests that amateur efforts to detect similar FRB-like bursts may be possible, and yield detections of currently-unknown FRBs.

The STARE2 project had aperture-linked sensitivity that could be described as “extremely modest”, trading aperture against detection bandwidth—with implied non-trivial costs in computing and receiver hardware.

We show an approach that uses an array of small dishes coupled to relatively-inexpensive receiver and detection chains to achieve potential detection of FRB-like noise bursts, based on the Gnu Radio framework.

## **A multi wavelength Extremely High Frequency Imaging Solar Radio Telescope Or**

### **How I learned to love my spectroheliograph**

David Iadevaia

The powerpoint presentation will focus on the Spectroheliograph as a “radio” receiver. Included will be a brief description of the electromagnetic spectrum, the nature of light and the Sun detailing its various atmospheric layers. The effects of chromospheric activity including CMEs disturbance of the Earth’s environment which results in failures of the electronic devices we so heavily depend on. A description of the spectroheliograph its operation and construction will be included

## **Faster Processing Techniques for Small Aperture Pulsar Detections**

Peter East

Amateur detection of weak low signal-to-noise ratio (SNR) pulsars with small aperture systems demands long observation times, implying extremely large data files. As a consequence, the processes necessary to prove pulsar recognition working on these large files can take a considerable time. This presentation offers some data processing techniques that significantly reduce the operating file sizes without losing valuable information. The result is much faster processing, tens of seconds rather than hours, allowing extraction of more and improved pulsar recognition detail than required by the usual professional validation measures. In this talk, the methods of analyzing pulsar properties to complete validation will be described from real data collected on pulsar B0329 by a small aperture system, through to the software working on full data analysis.

## SARA Student & Teacher Grant Program

All, SARA has a grant program that is, sad to say very underutilized. We will provide kits or money to students and teachers including college students to help them with a radio telescope project. SARA can supply any of the following kits:

- SuperSID
- Scope in a Box
- IBT (Itty Bitty Telescope)
- Radio Jove kit
- Inspire
- Sky Scan

We can also provide up to five hundred dollars (\$500.00 USD) for an approved radio telescope project.

We have on occasion provided more money based on the merits of the project and the SARA Grant Committee approval.

More information on the grant program can be found at the URL below.

[SARA Student and Teacher Project Grants | Society of Amateur Radio Astronomers \(radio-astronomy.org\)](https://www.radio-astronomy.org/SARA-Student-and-Teacher-Project-Grants)

All that is required is the SARA grant request form be filled out and sent in. If it needs more work for approval, we will work with the student to help ensure their success.

Please pass the word that SARA will fund any legitimate radio telescope project anywhere in the world.

If you have a question, contact me at [crowleytj at hotmail](mailto:crowleytj@hotmail.com) dot com.

Tom Crowley  
SARA Grant Program Administrator

## Drake's Lounge

Join the SARA community as we discuss the latest astronomy and radio astronomy news. The lounge also provides a forum to share and get advice on your radio astronomy projects from very experienced amateur radio astronomers.

Drake's Lounge is every month on the 3<sup>rd</sup> Sunday at 2 pm Eastern time. ZOOM email notifications will be sent to all members.

See you there!

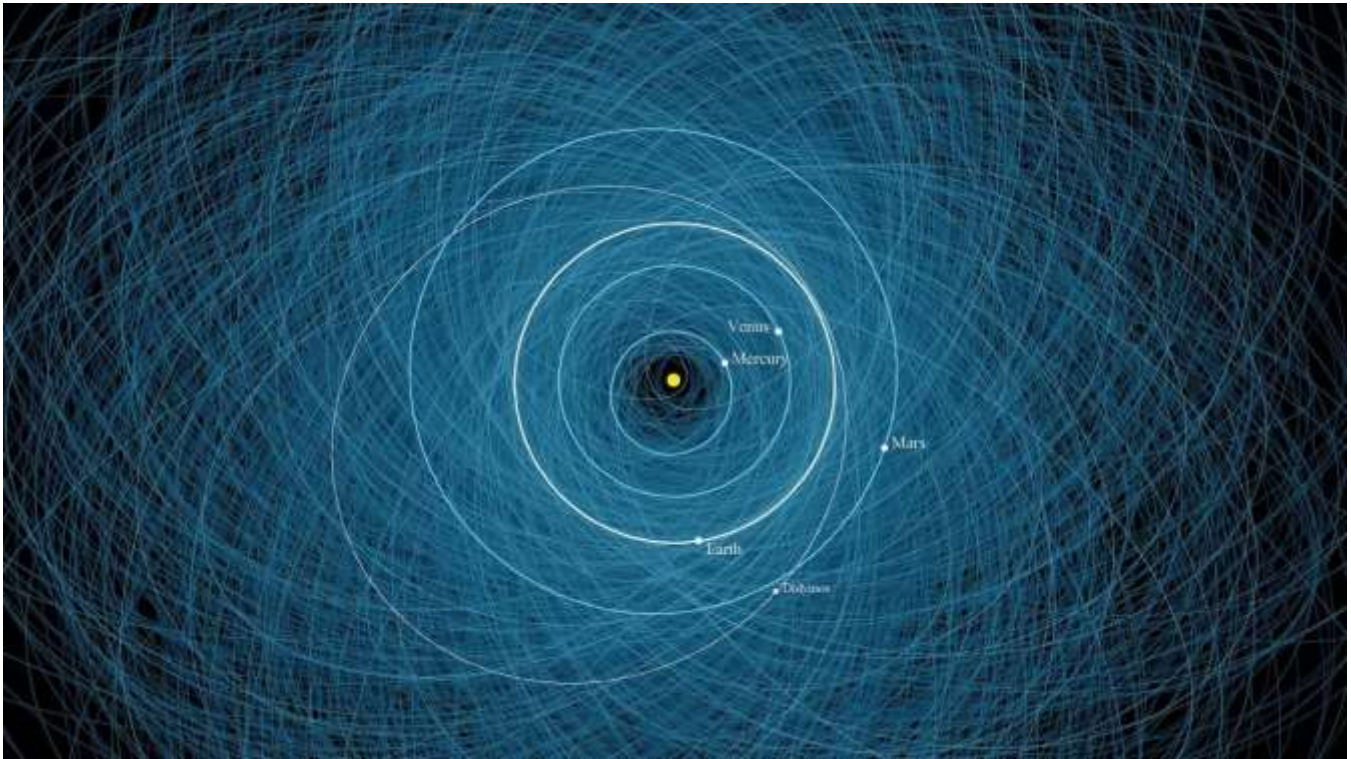

Hey, Mac, heads up!: Jet Propulsion Laboratory ~ *NASA's Next-Generation Asteroid Impact Monitoring System Goes Online*: <https://www.jpl.nasa.gov/news/nasas-next-generation-asteroid-impact-monitoring-system-goes-online>

Universe Today ~ *If you had Radio Telescopes for Eyes, one of the Biggest Things in the sky Would be a jet of Material Blasting out of a Nearby Galaxy*: <https://www.universetoday.com/153848/if-you-had-radio-telescopes-for-eyes-one-of-the-biggest-things-in-the-sky-would-be-a-jet-of-material-blasting-out-of-a-nearby-galaxy/>



McGill ~ *Real-time alert system heralds new era in fast radio burst research*: <https://www.mcgill.ca/newsroom/channels/news/real-time-alert-system-heralds-new-era-fast-radio-burst-research-335393>

Spaceweather.com ~ *Solar Cycle 25 Update*: <https://spaceweather.com/archive.php?view=1&day=12&month=01&year=2022>



Green Bank Observatory ~ *Are astronomers seeing a signal from giant black holes?*: <https://greenbankobservatory.org/ipta-gwb/>

Green Bank Observatory ~ *PING Summer Camp Experience, Physics Inspiring the Next Generation: Exploring the Cosmos! PING Camp 2022: July 24<sup>th</sup> – August 6<sup>th</sup>*: <https://greenbankobservatory.org/education/ping/>



SKA-France Bulletin, November-December 2021: <https://ska-france.oca.eu/images/SKA-France-Media/Bulletins/Bulletin54.pdf>

Universe Today ~ *What is the Arecibo Message?*:

<https://www.universetoday.com/153920/what-is-the-arecibo-message/>

Femilab ~ *Scientists move a step closer to understanding the “cold spot” in the cosmic microwave background*: <https://news.fnal.gov/2022/01/scientists-move-a-step-closer-to-understanding-the-cold-spot-in-the-cosmic-microwave-background/>

The ReadME Project ~ *Astronomy community shapes their own destiny with Astropy*: <https://github.com/readme/featured/webb-telescope-astropy>

Universe Today ~ *Finally, an Explanation for the Cold Spot in the Cosmic Microwave Background*: <https://www.universetoday.com/154147/finally-an-explanation-for-the-cold-spot-in-the-cosmic-microwave-background/>

New Atlas ~ *Bizarre radio signal repeating every 18 minutes discovered in Milky Way*: <https://newatlas.com/space/radio-signal-repeat-18-minutes-magnetar/>

Leiden University ~ *A much sharper picture of the universe with new algorithms and supercomputers*: <https://www.universiteitleiden.nl/en/news/2022/01/the-universe-much-sharper-in-the-picture-with-new-algorithms-and-supercomputers>

University of Leicester ~ *Juno and Hubble data reveal electromagnetic ‘tug-of-war’ lights up Jupiter’s upper atmosphere*: <https://le.ac.uk/news/2022/february/jupiter-tug-of-war>

Universe Today ~ *Astronomers Discover a Mysterious Star That Flashes Every 20 Minutes. But What is it?*: <https://www.universetoday.com/154287/astronomers-discover-a-mysterious-star-that-flashes-every-20-minutes-but-what-is-it/>

Spaceweather.com ~ *Geomagnetic Storm Brings Down Starlink Satellites* (see also Observations section in this issue of the SARA journal): <https://spaceweather.com/archive.php?view=1&day=09&month=02&year=2022>

Space.com ~ *What happened at the Arecibo Observatory? New inquiry launched into iconic telescope's collapse*: <https://www.space.com/arecibo-telescope-collapse-analysis-national-academies>

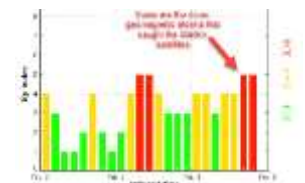
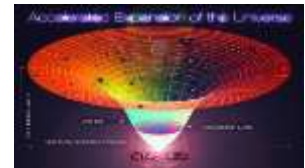
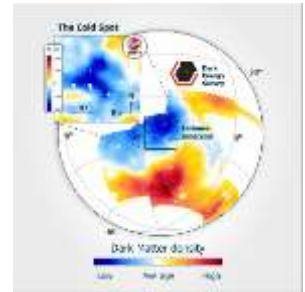



## Technical Knowledge & Education: (Jan-Feb 2022)

British Astronomical Association – Radio Astronomy Group ~ *Jodrell Bank, the cold war and the space race, Christmas Lecture Prof. Anna Scaife. Professor of Radio Astronomy at the University of Manchester:*

<https://www.youtube.com/watch?v=tyzGTd9Euu4>



Caltech ~ *Fast Radio Bursts - Liam Connor - 12/10/2021, Fast Radio Bursts, or FRBs, are short, powerful, beams of radio waves that come from galaxies billions of light years away. But what causes them, and why haven't we noticed them until a few years ago? Join us to learn the answers to these questions and more at a night of astronomy!:* <https://youtu.be/HRt-VMHNf1A>

Open Engineering ~ *Introduction to Scattering Parameters:*

<https://www.youtube.com/watch?v=CEA8njh4tLU>



Signal Integrity Journal ~ *A Free Impedance Analyzer on your Desktop:*

<https://www.signalintegrityjournal.com/blogs/4-eric-bogatin-signal-integrity-journal-technical-editor/post/2323-a-free-impedance-analyzer-on-your-desktop>

Sierra Circuits ~ *Why Controlled Impedance Really Matters:*

<https://www.protoexpress.com/blog/controlled-impedance-really-matters/>



Community of European Solar Radio Astronomers (CESRA) ~ *Radio Probing of Solar Wind Sources in Coronal Magnetic Fields:*

<https://www.astro.gla.ac.uk/users/eduard/cesra/?p=3192>



Maury Microwave ~ *On-demand demonstrations, tips & tricks, and webinars:*

<https://www.youtube.com/user/MauryMicrowave>

arXiv.org ~ *An Overview of CHIME, the Canadian Hydrogen Intensity Mapping Experiment:* <https://arxiv.org/abs/2201.07869>



arXiv.org ~ *Principles Of Heliophysics: a textbook on the universal processes behind planetary habitability:* <https://arxiv.org/abs/1910.14022>

Electronic Design ~ *What's the Difference Between Analog and Digital Multimeters?:*

<https://www.electronicdesign.com/technologies/test-measurement/article/21215098/simpson-electric-company-whats-the-difference-between-analog-and-digital-multimeters>



RF Cafe ~ *Vintage Radio-Craft Magazine Articles, 1929-1948:* <http://rfcafe.com/references/radio-craft/vintage-radio-craft-magazine-articles.htm>

Community of European Solar Radio Astronomers (CESRA) ~ *Signatures of Type III Solar Radio Bursts from Nanoflares: Modeling:* <https://www.astro.gla.ac.uk/users/eduard/cesra/?p=3203>

Copper Mountain Technologies ~ *Best Practices for VNA Test Set-up:* <https://coppermountaintech.com/webinar-vna-101-bootcamp-best-practices-for-vna-test-set-up/>

Frontiers in Astronomy and Space Sciences ~ *Four open-access space-physics electronic books are available to download or view:*

- ⚙ Machine Learning in Heliophysics: <https://www.frontiersin.org/research-topics/10384/>
- ⚙ Improving the Understanding of Kinetic Processes in Solar Wind and Magnetosphere: From CLUSTER to MMS: <https://www.frontiersin.org/research-topics/9195/>
- ⚙ Magnetic Flux Ropes: From the Sun to the Earth and Beyond: <https://www.frontiersin.org/research-topics/8284/>
- ⚙ Active Experiments in Space: Past, Present, and Future: <https://www.frontiersin.org/research-topics/7937/>



Copper Mountain Technologies ~ *Non-Destructive Microwave Evaluation of Radome Performance:*  
[https://www.bigmarker.com/copper-mountain-technologies/Non-Destructive-Microwave-Evaluation-of-Radome-Performance?utm\\_bmc\\_source=linksharing](https://www.bigmarker.com/copper-mountain-technologies/Non-Destructive-Microwave-Evaluation-of-Radome-Performance?utm_bmc_source=linksharing)

## Announcements



**Meeting Location and Dates:** We are happy to announce the virtual Heliophysics 2050: Measurement Techniques and Technologies Workshop scheduled for February 23–25, 2022.

**Purpose and Scope:** Following on the science framework envisioned by the community during the Heliophysics 2050 Workshop held in May 2021, the objective of this workshop is to enable and facilitate a community discussion to determine what technological advancements are needed to enable the broad scientific vision outlined by the Heliophysics 2050 Workshop and to make transformative advancements in Heliophysics. The workshop will be a forum to organize and solicit community inputs that will inform the upcoming Solar and Space Physics Decadal Survey by giving the community a platform to:

- Identify experimentation and technology gaps that must be closed in order to achieve the scientific vision laid out in the Heliophysics 2050 workshop
- Identify essential and missing measurement technologies necessary for significant advancements in solar and space physics
- Develop strategies to create an efficient pipeline of technological investment that could be used for long-term research

A vital element of this proposed workshop is to provide the Decadal Panel with:

- Identification of shortfalls in current methodologies
- Definition of instrument/sensor use cases that maximize the science return
- Identification of technology areas requiring new investment

Abstract submission is not required to participate in discussions; however, participants who choose to submit posters are asked to list measurement and potential missions that can benefit from these new techniques. All abstracts and final presentations from the workshop will be shared on a website that is publicly accessible.

**Registration:** Registration fees are not being collected for this virtual workshop, but [registration is required](#) for communication purposes, including virtual access information. Registration is available through February 25, 2022. For more information and registration: <https://www.hou.usra.edu/meetings/heliotech2022/>

---

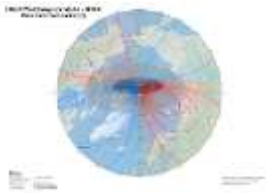

NOAA's National Centers for Environmental Information is excited to announce the release of the "State of the Geomagnetic Field, December 2021" report. In this report, the performance of the World Magnetic Model 2020 (WMM2020) was assessed by comparing its predictions at 2022-01-01 with that of a more recent model inferred from data collected by the European Space Agency Swarm satellites until September 2021. For all magnetic field components, the WMM2020 global root-mean-square error increased by less than 1.5% over the past two years and remained well below the maximum error allowed by the U.S. Department of Defense WMM specification. The report also includes an assessment of the WMM secular variation, and descriptions of noteworthy changes in the Earth's main magnetic field, including magnetic pole drifts and the deepening of the South Atlantic Anomaly. The complete report can be accessed [here: https://www.ngdc.noaa.gov/geomag/WMM/data/WMMReports/WMM\\_Annual\\_Report\\_2021.pdf](https://www.ngdc.noaa.gov/geomag/WMM/data/WMMReports/WMM_Annual_Report_2021.pdf)

Going forward, we plan to update this report on an annual basis, except for the years when we release a new World Magnetic Model. Note that we did not update the World Magnetic Model. No action is required at this point of time to update WMM in your system. The next regular update of WMM will happen in December 2024.

You are invited to take part in the session **EMRP 2.15** (Co-organized by ST4) entitled:

**Measuring space weather condition with geomagnetic data**



that will be held at the EGU 2022 General Assembly (3-8 April 2022, Vienna, Austria). Please note that abstract submission will close on: 12 January 2022 at 13:00 CET

**Session description:** It is well known that solar activity influences the state of the circumterrestrial space and can affect technological systems in many different ways and with different degrees of damage severity. Geomagnetic data, both from ground-based observatories and low Earth orbit satellites, represent a powerful tool to monitor space weather events, such as magnetic storms, substorms and geomagnetically induced currents. Geomagnetic field monitoring makes it possible to improve internal geomagnetic field models and gain better knowledge on the dynamics of solar-terrestrial events and ionospheric and magnetospheric geomagnetic sources (both internal and external). Furthermore, geomagnetic field data provide proxies to nowcast and forecast different ground effects due to space weather events. In this session we therefore encourage submissions focusing on the use of geomagnetic data (from ground observatories to satellites such as CHAMP, Swarm, CSES, ePOP and others) as a tool to gain insight both into the physics of the processes involving the Earth's magnetic field in response to space weather events and into their effects as the degradation of satellite signal, perturbation in radio communications, disruption of power system devices, just as some known examples.

For **abstract submission** visit: <https://meetingorganizer.copernicus.org/EGU22/session/44139>

**Session conveners:** Roberta Tozzi, Paola De Michelis, M. Alexandra Pais



---

## HamSCI Virtual Workshop March 18-19, 2022 - Call for Abstracts

From: Nathaniel Frissell (nathaniel.frissell[at]scranton.edu)

I am happy to announce that we will be holding a hybrid in-person and virtual HamSCI Workshop at the US Space and Rocket Center Educators Training Facility in Huntsville, AL this coming March 18-19, 2022.

The primary objective of the HamSCI workshop is to bring together the amateur radio community and professional scientists. For the past four years, the workshop has been an excellent place for professionals and citizen scientists alike to share ideas, plan experiments, and develop instrumentation related to radio and space science. This year's theme is The Weather Connection, with invited speakers Dr. Tamitha Skov WX6SWW and Mr. Jim Bacon G3YLA presenting tutorials on the impacts of both space and terrestrial weather on the ionosphere, and a keynote presentation by Dr. Chen-Pang Yeang on Ham Radio and the Discovery of the Ionosphere. We welcome abstract submissions related to development of the Personal Space Weather Station, ionospheric science, atmospheric science, radio science, space weather, radio astronomy, and any science topic that can be related to space science and/or the amateur radio hobby.



The 2022 HamSCI Workshop is organized by The University of Scranton in collaboration with The University of Alabama and NASA Marshall Space Flight Center. Financial support is provided by the United States National Science Foundation.

To submit an abstract, please visit <https://hamsci.org/hamsci2022> . Abstracts are due February 1, 2022. Workshop registration will open in early to mid-January 2022.

This is an excellent opportunity for you (or your students!) to participate in citizen science and possibly foster future collaborations.

-----  
Dr. Nathaniel A. Frissell, Ph.D., W2NAF (He/Him)  
HamSCI Lead / Assistant Professor  
Department of Physics and Electrical Engineering  
University of Scranton  
(973) 787-4506

---

INTERNATIONAL EARTH ROTATION AND REFERENCE SYSTEMS SERVICE (IERS)  
SERVICE INTERNATIONAL DE LA ROTATION TERRESTRE ET DES SYSTEMES DE REFERENCE

SERVICE DE LA ROTATION TERRESTRE DE L'IERS, OBSERVATOIRE DE PARIS  
61, Av. de l'Observatoire 75014 PARIS (France)  
Tel.: +33 1 40 51 23 35  
e-mail: services.iers@obspm.fr  
<http://hpiers.obspm.fr/eop-pc>

Paris, 05 January 2022

## Bulletin C 63

To authorities responsible for the measurement and distribution of time:

### INFORMATION ON UTC - TAI

NO leap second will be introduced at the end of June 2022. The difference between Coordinated Universal Time UTC and the International Atomic Time TAI is:

From 2017 January 1, 0h UTC, until further notice:  $UTC - TAI = -37 \text{ s}$

Leap seconds can be introduced in UTC at the end of the months of December or June, depending on the evolution of UT1-TAI. Bulletin C is mailed every six months, either to announce a time step in UTC, or to confirm that there will be no time step at the next possible date.

Christian BIZOUARD, Director, Earth Orientation Center of IERS, Observatoire de Paris, France

Earth rotation acceleration: the length of day (LOD) since decreases in average by 0.3 ms/year since 2016:

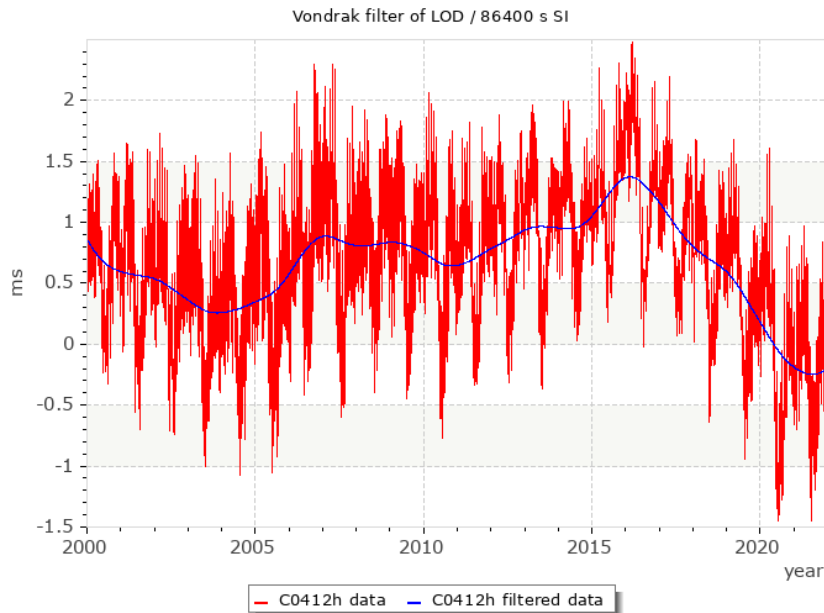

Last leap second: 31 December 2016, TAI – UTC: 37 s, Next leap second: Not scheduled

---

### MEETING: NASA Workshop on Lightning-Related Research Beyond the Troposphere

From: Timothy Lang (NASA MSFC), Shing F. Fung (NASA GSFC, shing.f.fung at nasa.gov), Sarah Bang (NASA MSFC), Burcu Kosar (NASA GSFC), and Mason Quick (NASA MSFC)

This is to announce that NASA is organizing a virtual scientific workshop to be held on May 2-3, 2022. The goal of the workshop is to identify key lightning-related research topics and science questions that fall into gaps between the NASA SMD Divisions. The workshop will cover lightning-related phenomena occurring beyond the Earth's troposphere and will include (but not limited to) Transient Luminous Events (TLEs; e.g., sprites, jets), Terrestrial

Gamma-ray Flashes (TGFs), sferics, electron precipitation from Earth's radiation belts, detection of bolides by spaceborne optical lightning mappers, lightning on other planets, and more.

In addition, NASA would like to gather information to describe how lightning-related research is being carried out by the community and determine how that work could be supported through better collaboration across SMD Divisions. The community's input will then inform the agenda of the upcoming workshop. Furthermore, this community input and the results of the workshop could help formulate future NASA research opportunities. Community input on lightning-related research can be provided before 02/28/2022 @ <https://TinyURL.com/NASALightning>.

---

Lawrence Livermore National Laboratory (LLNL) is now providing an update to NEC-5 provided by Roy Lewallen. A special thanks to Roy Lewallen for his long support of NEC and for providing our user community with updates. Dan Maguire also made major contributions in identifying and extensively testing and verifying the improvements.

Improvements to the command line NEC-5 program in the updated package consist of corrections of several serious bugs involving current sources and MININEC type ground among others. Corrections to the command line NEC-5 program address the following bugs:

- ⚙ Incorrect gain was reported when using current sources.
- ⚙ Near field and surface wave results were incorrect when using MININEC type ground.
- ⚙ Inhibiting Sommerfeld ground file writing by specifying NOFILE as the file name caused a crash.
- ⚙ An internal array dimension (NETSOLMAXX in SUBROUTINE ALLOC\_NETWORK\_SOL) wasn't large enough and could cause a crash under some conditions.
- ⚙ Errors could occur or the program crash if any NT or TL port was placed at end 1 of a segment.

Please visit <https://downloadnec5.llnl.gov> to download the update, NEC5\_X11 (NEC5 license required).

For questions, contact:

Mary Holden-Sanchez, IP Specialist  
Innovation & Partnerships Office (IPO)  
Lawrence Livermore National Laboratory  
+1 925-422-4614

---



**European Space Weather Week 2022**  
18th European Space Weather Week  
October 24-28, 2022, Zagreb, Croatia

Each year, during the European Space Weather Week (ESWW) conference, people from all over the world gather to discuss the newest insights and state-of-the-art in space weather; endeavoring to address the challenges and impacts that space weather poses. Science, data exploitation, observations, service development, operational models, engineering, industrial challenges, etc., are all relevant and some of the most important aspects of space weather. The overarching theme for ESWW2022 is 'The importance of comprehensive space weather monitoring', with a number of session topics reflecting this theme.

One of the strengths of the conference is that the participants can contribute largely to its content. We would like to invite and encourage you and your colleagues to submit a proposal for a session in one of the three formats:

- ⊗ Plenary session
- ⊗ Parallel Space Weather Research session
- ⊗ Parallel 100% Community-Driven session

For more information on the plans and expectations for these session types please visit the meeting website:

<https://www.stce.be/esww2022/call4sessions.php>

The online submission opens 31st January and the deadline for submission is 13th April 2022, included. The submission system can be accessed here: <https://register-as.oma.be/esww2022/>

When submitting a session proposal, the following is required:

- Topic/title of the session
- Name, affiliation and email address of the conveners
- Session abstract (max 1500 characters)

There are some further details depending on the type of the session for which the submission applies. Diversity in conveners is encouraged, and the successful conveners will need to have at least one session chair that can attend in person, in Croatia (can be decided in a later stage).

The ESWW Programme Committee (PC) will decide which of the submitted sessions are accepted. The PC strongly encourages those who have not previously submitted to convene a session to do so. Session conveners will be notified by mid-May.

ESWW2022 website: <https://www.stce.be/esww2022/>

Follow us on facebook (European Space Weather Week 2022 ), twitter (ESWW2022), linkedin (ESWW conference) and instagram (esww2022)



## ***Collaboration: Advancing the Space Weather Enterprise***

The 2022 Space Weather Workshop will be held virtually April 26-28, 2022. This meeting will bring together Federal agencies, the academic community, the private sector, and international partners to focus on the diverse impacts of space weather, on forecasting techniques, and on recent scientific advances in understanding and predicting conditions in the space environment. The theme for this year's workshop is: Collaboration: Advancing the Space Weather Enterprise.

The program will highlight impacts in several areas, including: space traffic coordination, aviation, human spaceflight and exploration, satellites, power grids, and other industries affected by space weather. The conference will also include an update on the national and international space weather programs to mitigate and respond to space weather impacts on society. We welcome a broad range of participation, including representatives from research and development, space weather service providers, policy development, and industries impacted by space weather.

The Space Weather Workshop is coordinated by the University Corporation for Atmospheric Research and co-sponsored by the NOAA Space Weather Prediction Center, the NSF Division of Atmospheric and Geospace Sciences, and the NASA Heliophysics Division.

For workshop information and to register (no registration fee this year), please visit <https://cpaess.ucar.edu/space-weather-workshop-2022> . The program, speakers, poster presentations, information for a student program, and other relevant information will be provided at the meeting registration site and in future announcements.

---

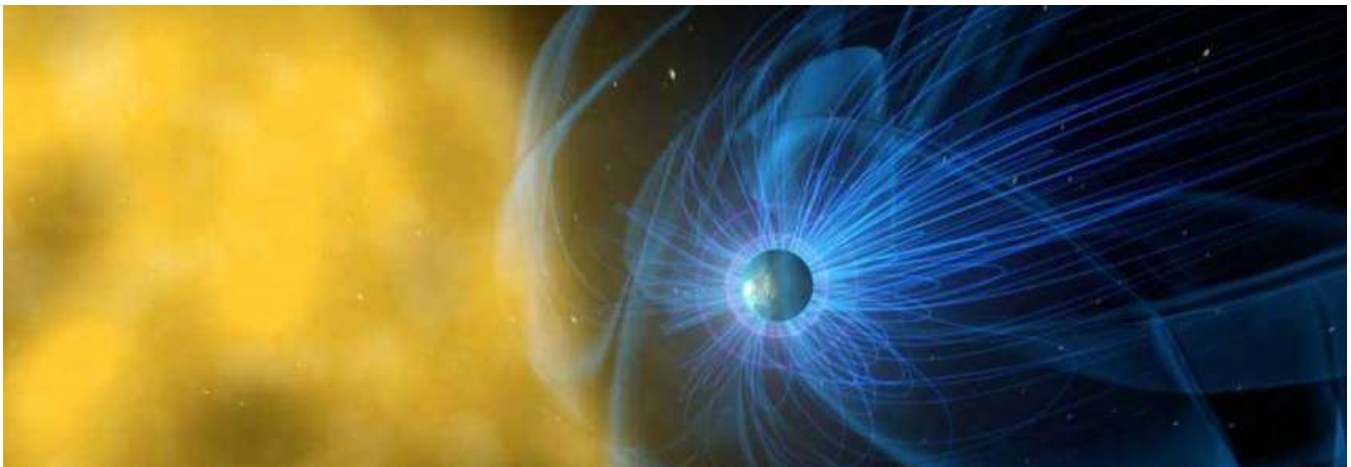

UK Royal Astronomical Society Specialist Discussion Meeting on ULF Waves

From: Tom Elsdén, Matt James, Jasmine Sandhu, Clare Watt (thomas.elsden[at]glasgow.ac.uk)

We would like to invite your participation in the upcoming Royal Astronomical Society Specialist Discussion Meeting: <https://ras.ac.uk/events-and-meetings/ras-meetings/planetary-ultra-low-frequency-waves-theory-modelling-and>

Planetary Ultra-low Frequency Waves: Theory, Modelling and Observations

**Date:** Friday 11th March 2022, 1030-1530 GMT.

**Format:** Online

**Abstract deadline:** 18th February 2021

**Meeting abstract:** Ultra-Low Frequency (ULF) waves play a critical role in the transmission of energy and momentum throughout many magnetized plasma environments and have been observed ubiquitously in magnetospheres throughout the solar system. In particular, observations and modelling have shown the importance of ULF waves regarding radiation belt energization and decay at Earth, Saturn and Jupiter. ULF waves can also manifest as field line resonances, as observed at Earth, Mercury, Saturn, and Jupiter, that have wider impacts on local plasma distributions and auroral processes.



Overall, ULF waves in these distinct plasma environments are associated with similar generation mechanisms including solar wind interactions and plasma instabilities. The similarities and differences between ULF wave dynamics in these magnetospheres present an opportunity to understand both the fundamental characteristics of ULF wave processes, as well as the dependence of ULF waves on their environment. With such a wealth of data available for the study of magnetospheric ULF waves e.g. vast arrays of ground-based instruments at Earth (e.g. SuperDARN, ground magnetometer networks) and direct in-situ spacecraft measurements at Mercury, Earth, Jupiter and Saturn (e.g. Van Allen Probes, Arase, THEMIS, MESSENGER, Juno, Cassini, etc.), theory and modelling are ever more important to provide physical explanations for the observations.

We therefore welcome contributions across all aspects of ULF wave research, including observations, modelling and theory. Topics which are of particular interest are (but not limited to): drivers of ULF wave activity, wave-particle interactions involving ULF waves, ULF wave power distribution, field line resonance, drift and drift-bounce resonance, cavity/waveguide modes, conjugate observations involving ground/space instrumentation, ULF wave activity at other planets and their comparison to Earth.

**Abstract submission:** Abstract submission is now open, please fill in the following form to submit your abstract: <https://forms.office.com/Pages/ResponsePage.aspx?id=KVxybjp2UE-B8i4ITwEzyNnrj0Db2HhLjTScpW7YQBBOVhLUVNESEJMM1BTNk0yWExEWky0TDNKSS4u>

If for some reason this link does not work, please contact Tom Elsdon: [thomas.elsden\[at\]glasgow.ac.uk](mailto:thomas.elsden[at]glasgow.ac.uk)

Please note that registration for the meeting will follow separately to abstract submission, closer to the date of the meeting. The meetings are free for Fellows and £5 for non-fellows.

---

## American Journal of Astronomy and Astrophysics

American Journal of Astronomy and Astrophysics, <http://www.astronomyjournal.org/>

Open Access (OA) – Double-anonymous Peer Review Mechanism – Paper Publication in 70 Days

American journal of Astronomy and Astrophysics (AJAA) is an open access scientific journal, which uses double-blind peer review. It aims to serve as a platform for academic communications on all topics related to astronomy and astrophysics.

Paper Invitation: Initiated with an aim to promote communications among academic peers, AJAA can keep researchers in the related fields updated with the latest scientific research. We would like to invite you to send unpublished manuscripts of relevant fields to the journal. Manuscript submission: <http://www.ajoa.org/sealwb0/pPAel>

---

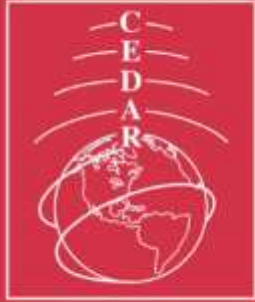

## Solar and Space Physics Decadal Survey White Papers Workshops

### **Solar and Space Physics Decadal Survey White Papers Workshop #3:**

The Future of Ground-Based Research for Magnetospheric and ITM Physics Workshop, March 15–16, 2022

This workshop is focused on organizing the writing of Magnetospheric and ITM Physics Decadal White Papers on the future of ground-based studies in enabling cutting-edge science in a wide range of areas. Presenters will discuss the technological and infrastructure requirements to set the foundation of truly transformational science. Participants will be encouraged to suggest white paper topics and/or join in as co-authors on existing white papers, with the aim of promoting ground-based observations as a core strategy in the future of Heliophysics.

<https://www.hou.usra.edu/meetings/decadalsurvey2021/workshop3/>

---



**SuperSID**  
*Collaboration of Society  
of Amateur Radio  
Astronomers and  
Stanford Solar Center*



- ✓ Stanford provides data hosting, database programming, and maintains the SuperSID website
- ✓ Society of Amateur Radio Astronomers (SARA) sells the SuperSID monitors for 48 USD to amateur radio astronomers and the funds are then used to support free distribution to students all over the world (image below as of Fall 2017)
- ✓
- ✓ Jonathan Pettingale at SARA is responsible for building and shipping the SuperSID monitor kits: [SuperSID@radio-astronomy.org](mailto:SuperSID@radio-astronomy.org)
- ✓ SuperSID kits may be ordered through the SARA SuperSID webpage: <http://radio-astronomy.org/node/210>
- ✓ Questions about the SuperSID project may be directed to Steve Berl at Stanford: [steveberl@gmail.com](mailto:steveberl@gmail.com)
- ✓ Jaap Akkerhuis at Stanford is responsible for the SuperSID software and SARA has provided financial support for his efforts
- ✓ SuperSID website hosted by Stanford: <http://solar-center.stanford.edu/SID/sidmonitor/>
- ✓ SuperSID database: <http://sid.stanford.edu/database-browser/>
- ✓ The data is searchable by time, station, date, and multiple plots may be placed on the same graph for comparison.

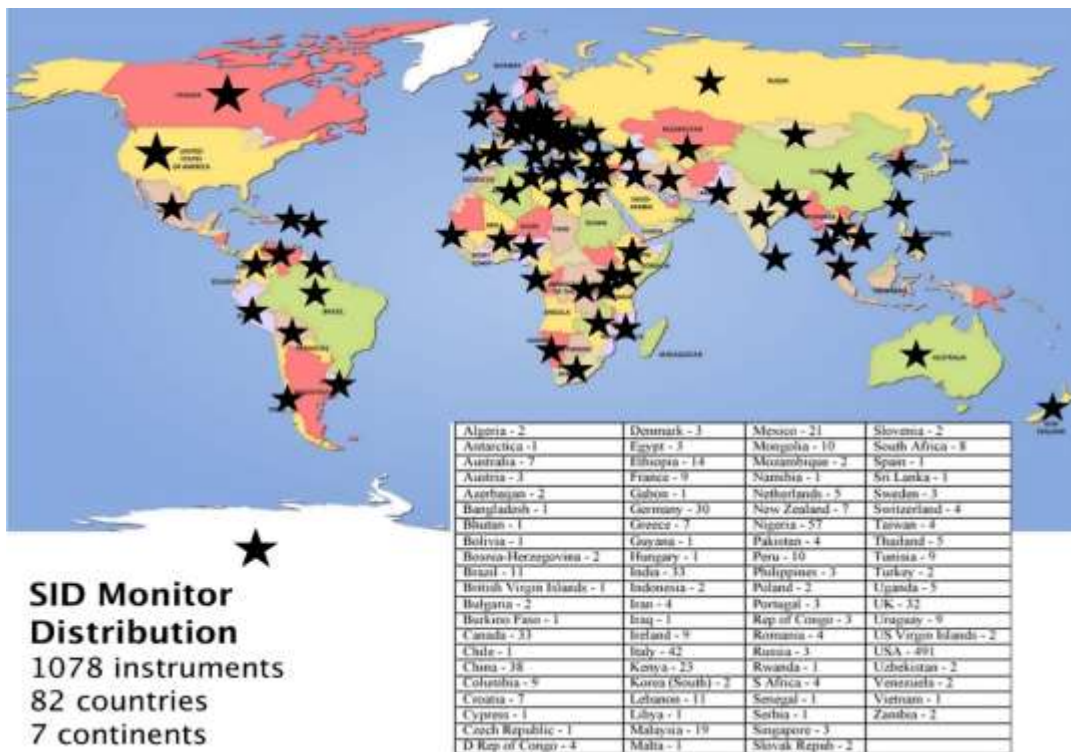



For official use only  
 Monitor assigned: \_\_\_\_\_  
 Site name: \_\_\_\_\_  
 Country: \_\_\_\_\_

## SuperSID Space Weather Monitor Request Form

	<i>Your information here</i>		
Name of site/school (if an institution):			
Choose a site name: <b>(3-6 characters) No Spaces</b>			
Primary contact person:			
Email:			
Phone(s):			
Primary Address:	Name School or Business Street Street City Country	State/Province Postal Code	
Shipping address, if different:	Name School or Business Street Street City Country	State/Province Postal Code	
Shipping phone number:			
Latitude & longitude of site:	Latitude: _____ Longitude: _____		

**I understand that neither Stanford nor the Society of Amateur Radio Astronomers is responsible for accidents or injuries related to monitor use. I will assure that a surge protector and other lightning protection devices are installed if necessary.**

**Signature:** \_\_\_\_\_ **Date:** \_\_\_\_\_

*I will need:*

<i>What</i>	<i>Cost</i>	<i>How many?</i>
SuperSID distribution USB Power	\$48 (assembled)	
USB Sound card 96 kHz sample rate (or provide this yourself)	\$40 (optional)	
Antenna wire (120 meters) (or you can provide this yourself)	\$23 (optional) with connectors attached and tested	
RG 58 Coax Cable (9 meters) (or provide this yourself)	\$14 (optional) with connectors attached and tested	
Shipping	US \$12 Canada & Mexico \$40 all other \$60	
	<b>TOTAL</b>	\$

\_\_\_\_\_ I have included a \$\_\_\_\_\_ check (payable to SARA)

\_\_\_\_\_ I will make payment thru [www.paypal.com](http://www.paypal.com) to [treas@radio-astronomy.org](mailto:treas@radio-astronomy.org)

or

\_\_\_\_\_ If you are a Minority-serving institution, in a Developing or economically deprived nation, and/or you are using the monitor with students for educational purposes, you may qualify for obtaining a monitor at reduced or no cost. Check here if you wish to apply for this designation. Then tell us how you want to use the SuperSID monitor. Include type of site, number of students involved, whether public or private school, grade levels, etc. and describe your program. The goal of the SuperSID project is to provide as many students with systems as possible. If you are able to pay for a system, even if you qualify for a free one, please do so and help support our goal.

---

---

---

---

For more details on the Space Weather Monitor project, see: <http://sid.stanford.edu>

To set up a SuperSID monitor you will need:

1. Access to power and an antenna location that is relatively free of electric interference (could be indoors or out)
2. A **PC\*\*** with the following minimal specifications:
  - A sound card that can record (sample) up to 96 kHz, or a USB port to connect such a sound card (for North and South America)
    - All other countries can use AC97 sound card with 48 kHz record (sample) rate. Most computers made after 1997 will have AC97.
  - Windows 2000 or more recent operating system
  - 1 GHz Processer with 128 mb RAM
  - Ethernet connection & internet browser (desirable, but not required)
  - Standard keyboard, mouse, monitor, etc.
3. An inexpensive antenna that you build yourself. You'll need about 120 meters (400 feet) of **insulated** wire. Solid wire is easier to wind than stranded. Magnet wire will work but be more fragile. You can use anything from #18 to #26 size wire. The antenna frame can be made of wood, PVC pipe, or similar materials. We'll provide instructions. You can purchase the wire from us or obtain your own.
4. RG58 coax cable with a BNC connector at one end to run from the antenna to the SuperSID receiver. 9 meters is recommended, but the length will depend on where you place the antenna. You can purchase the coax from us or obtain your own.
5. Surge protector and other protection against a lightning strike

---

Return this form to: [SuperSID@radio-astronomy.org](mailto:SuperSID@radio-astronomy.org)

or mail to: SARA  
Brian O'Rourke, SARA Treasurer  
337 Meadow Ridge Rd,  
Troy, VA 22974-3256



# The British Astronomical Association

A company limited by guarantee

Registered Charity No. 210769

Burlington House, Piccadilly, London, W1J 0DU

Telephone: 020 7734 4145

Fax No.: 020 7439 4629

Email: office@britastro.org

Website: www.britastro.org



Please send all reports and observations to [jacook@jacook.plus.com](mailto:jacook@jacook.plus.com)

## John Cook's VLF Report

BAA Radio Astronomy Section

2021 NOVEMBER

Solar activity in November was much lower than the last few months, despite the higher sunspot count. We recorded just three C-class flares as SIDs. There were also three M-class flares shown in the satellite X-ray data, but they were all during our European night time. The strongest was an M2.0 on the 9<sup>th</sup>.

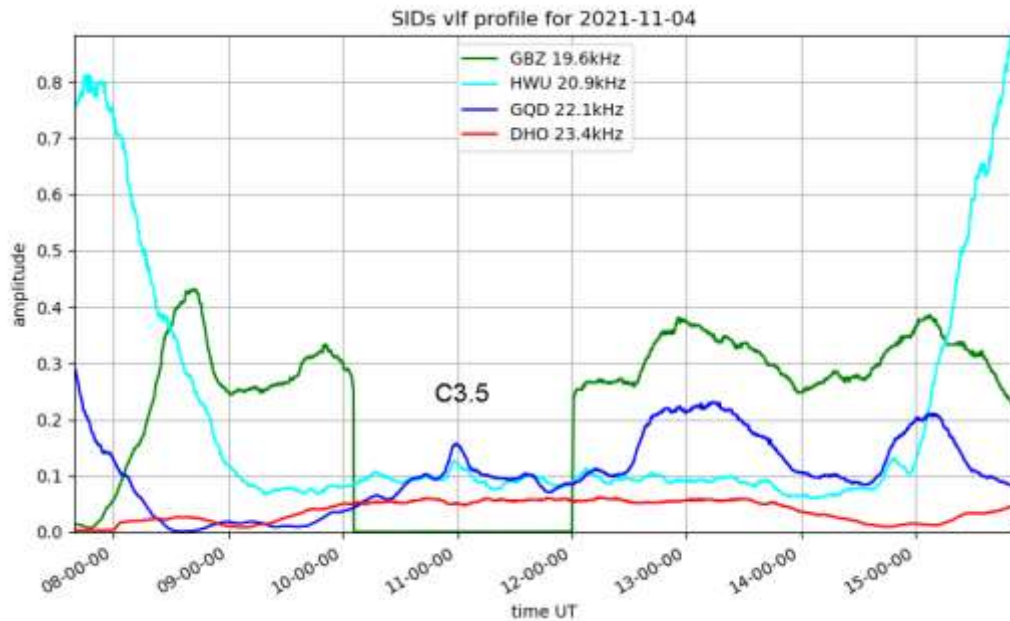

This recording by Mark Prescott shows the C3.5 flare on the 4<sup>th</sup> quite well at 20.9 and 22.1kHz, despite the rather noisy day-time signal. The 20.9kHz signal also clearly shows the short observing period from 09 to 15UT available at this time of year. With the low altitude of the sun in the sky, the ionosphere is also more noticeably affected by changing weather patterns, leading to very noisy signals that hide the smaller flares. My own recording from the 4<sup>th</sup> shows the problem:

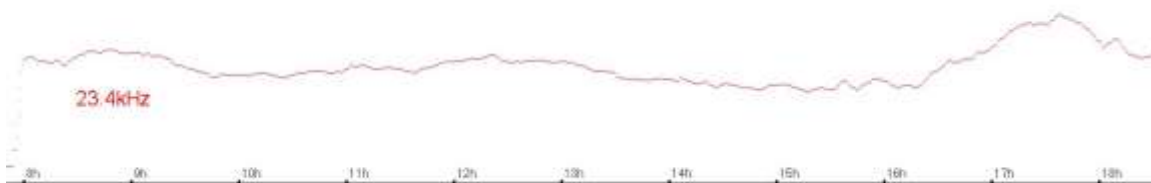

This 'noise' can become more organised in the form of distinct waves, as shown in this recording from the 22<sup>nd</sup>, by Mark Edwards. The 37.5kHz signal (blue) is very clean.



### MAGNETIC OBSERVATIONS

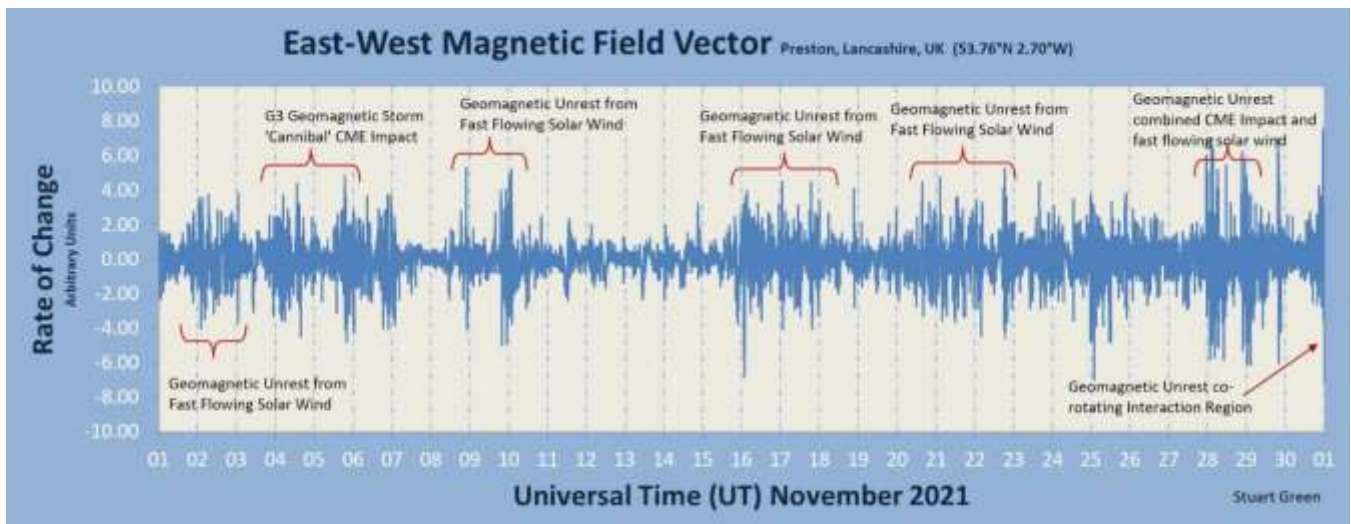

Magnetic activity was much higher, with most days in November showing some disturbance. This was mostly from a faster turbulent solar wind, with some coronal mass ejections. A mild disturbance from the CME at the end of October continued into November 1<sup>st</sup>, mixed with a faster flowing solar wind from a north-polar coronal hole. This was rapidly followed by a pair of CMEs from the M-class flares on the 1<sup>st</sup> and 2<sup>nd</sup>, the second catching up with the first to produce some very active conditions starting on the 3<sup>rd</sup>. The following chart from Roger Blackwell shows the activity:

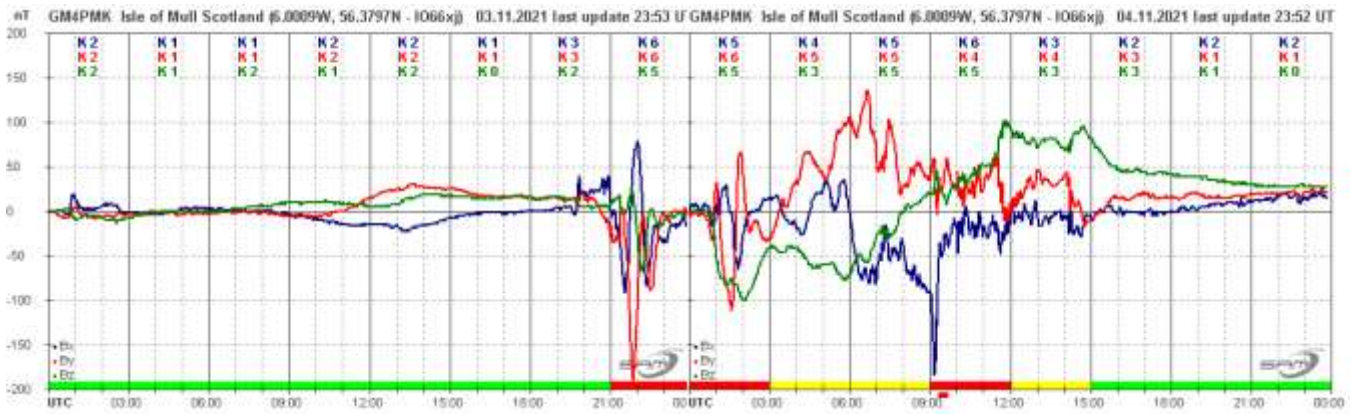

The arrival shock from the first CME can be clearly seen at about 19:45UT, followed by very rapid and deep fluctuations in the magnetic field. This was repeated again in the morning of the 4<sup>th</sup> as the second CME caught up and added to the disturbance. The disturbance was also recorded on the 37.5kHz signal from Iceland:

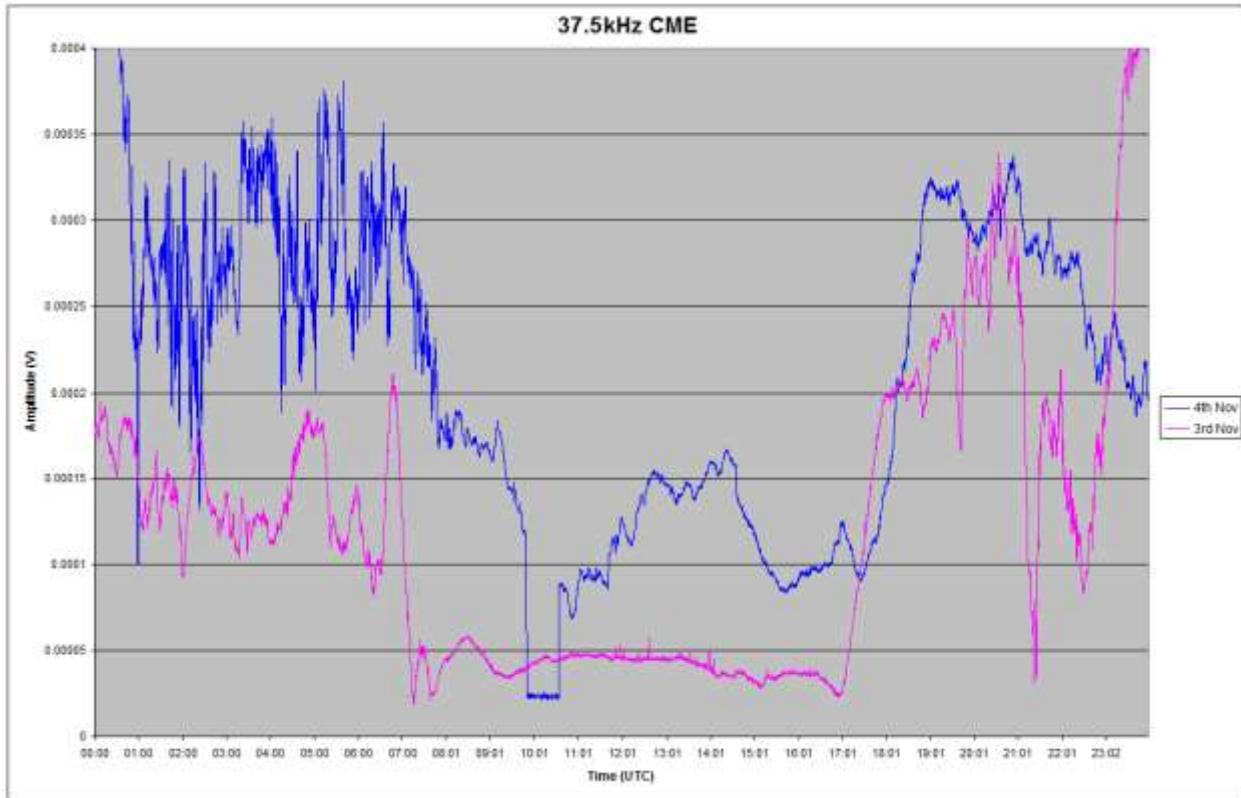

Mark Edwards' recording shows the 3<sup>rd</sup> on the pink trace, compared with the 4<sup>th</sup> in blue. The signal break at 10UT on the 4<sup>th</sup> is unfortunate, but the general disturbance is very clear. Mild magnetic disturbances continued over the next few days, with another VLF disturbance showing on the 6<sup>th</sup>. The recording by Paul Hyde shows a very SID-like feature at 11:30 on all four signals. Mark Edwards also noted this feature. It does match the timing of a mild magnetic disturbance.



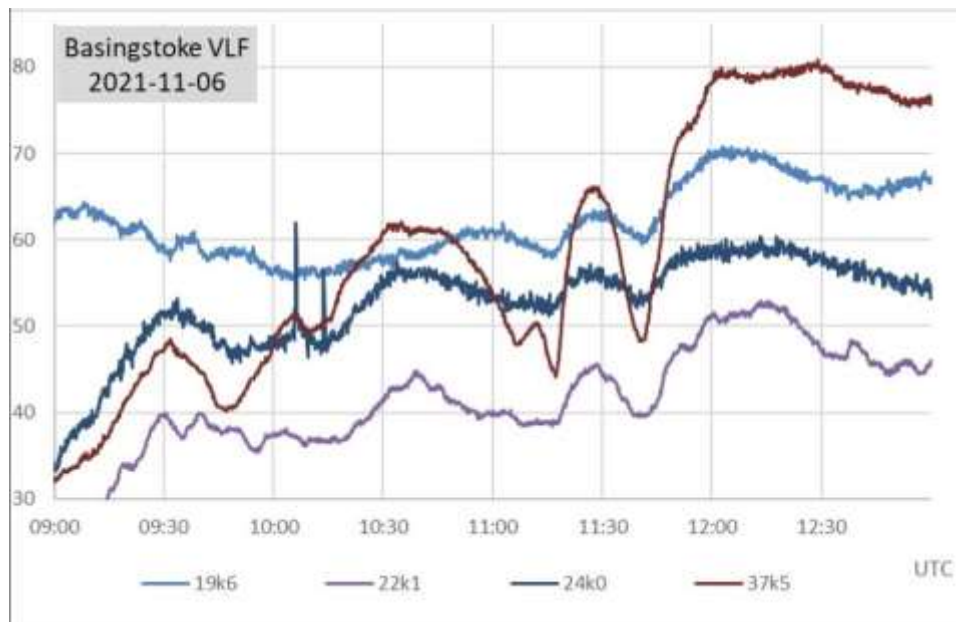

High speed solar wind from a south-polar coronal hole created a period of disturbance over the 15<sup>th</sup> and 16<sup>th</sup>, shown in this recording by Andrew Thomas:

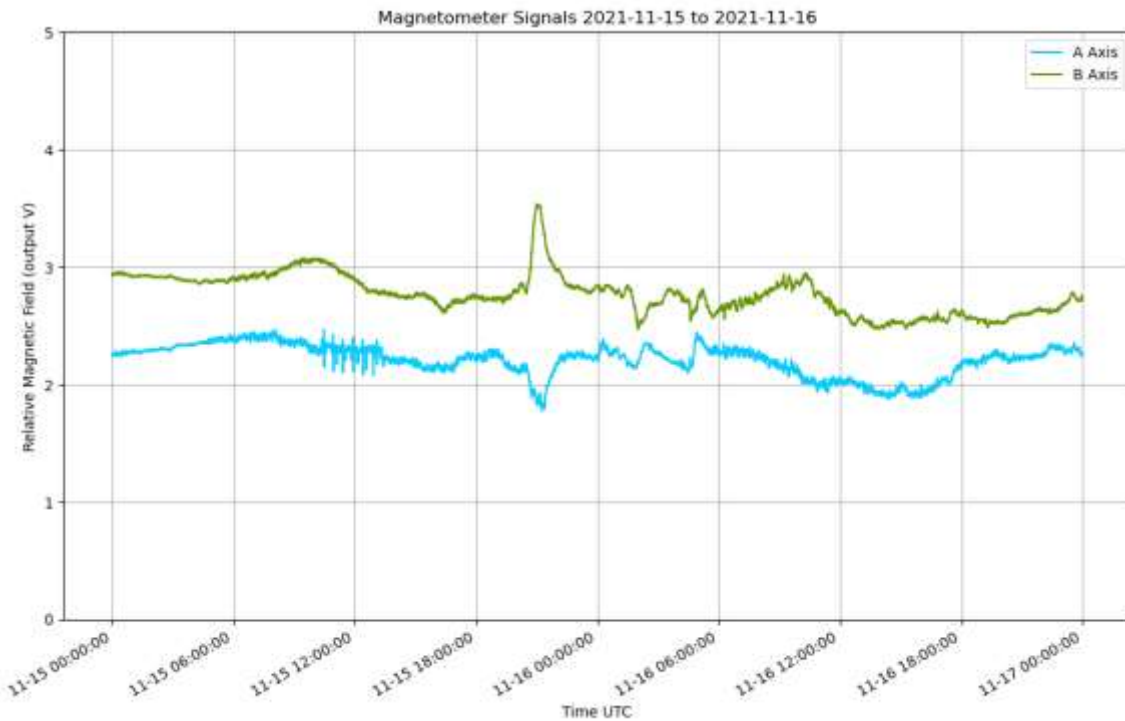

The impulsive bursts around 12UT on the 15<sup>th</sup> appear to be a local effect, the solar wind impact being at about 20:30. The disturbance continued into the early afternoon on the 16<sup>th</sup>, with some genuine impulsive effects after 06UT.

November ended with a complex mixture of coronal hole and CME effects, starting on the 20<sup>th</sup>. Colin Clements made this recording on the 20<sup>th</sup>:

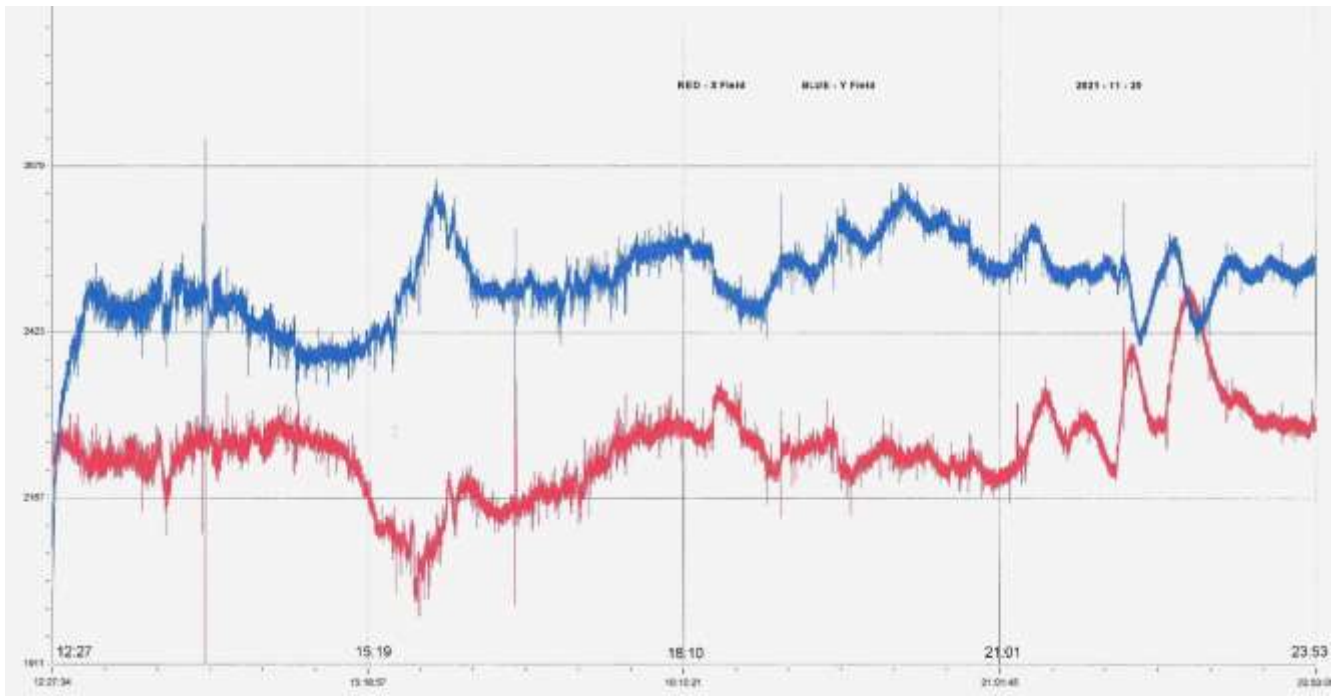

This disturbance was again from the south-polar coronal hole high speed wind, which was joined by another coronal hole over the next few days. A filament eruption detected in satellite images on the 24<sup>th</sup> produced a CME that arrived on the 27<sup>th</sup>. Its effects were very mild initially, but an increased wind speed at the end of the month led to a more active disturbance late on the 30<sup>th</sup>. This is shown in the recording by Nick Quinn:

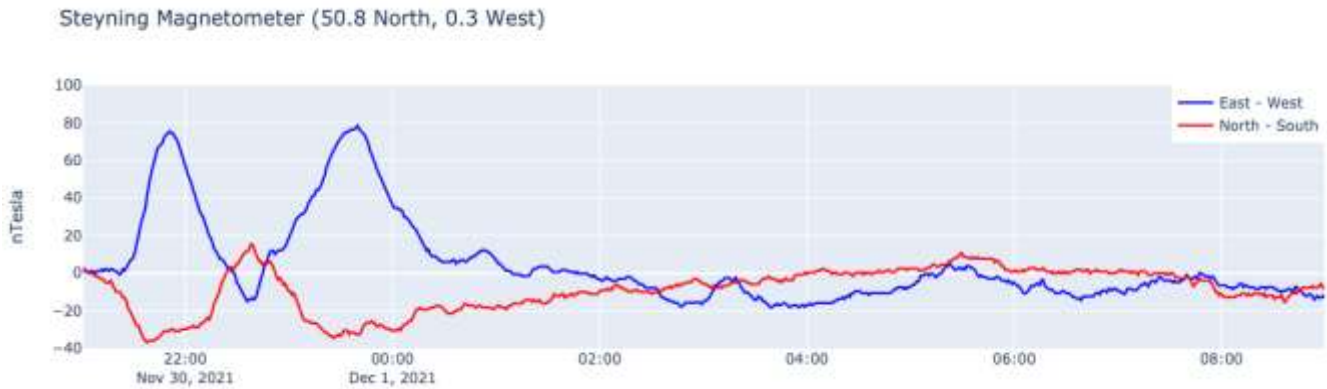

Magnetic observations received from Roger Blackwell, Colin Clements, Andrew Thomas, Nick Quinn and John Cook.

### METEOR COUNTS

We have not received any specific recordings from the November Leonids, but Mark Prescott has sent a chart of GRAVES echoes recorded through the year so far. This also shows the unexpected peak on October 6<sup>th</sup> noted in last month's report. The colour background shows the counts per hour for each day, while the white graph line shows the daily mean counts. The August Perseids stand out, along with that early October peak.

### Meteor echoes (GRAVES radar) 2021

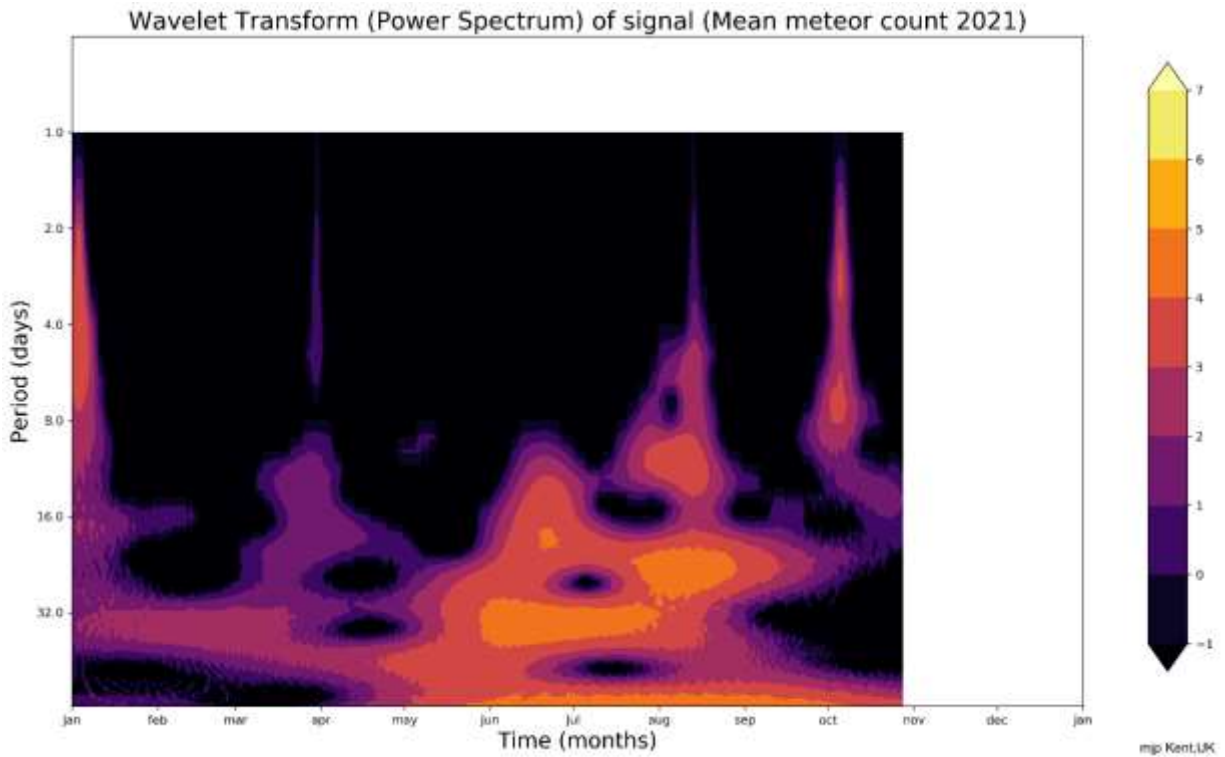
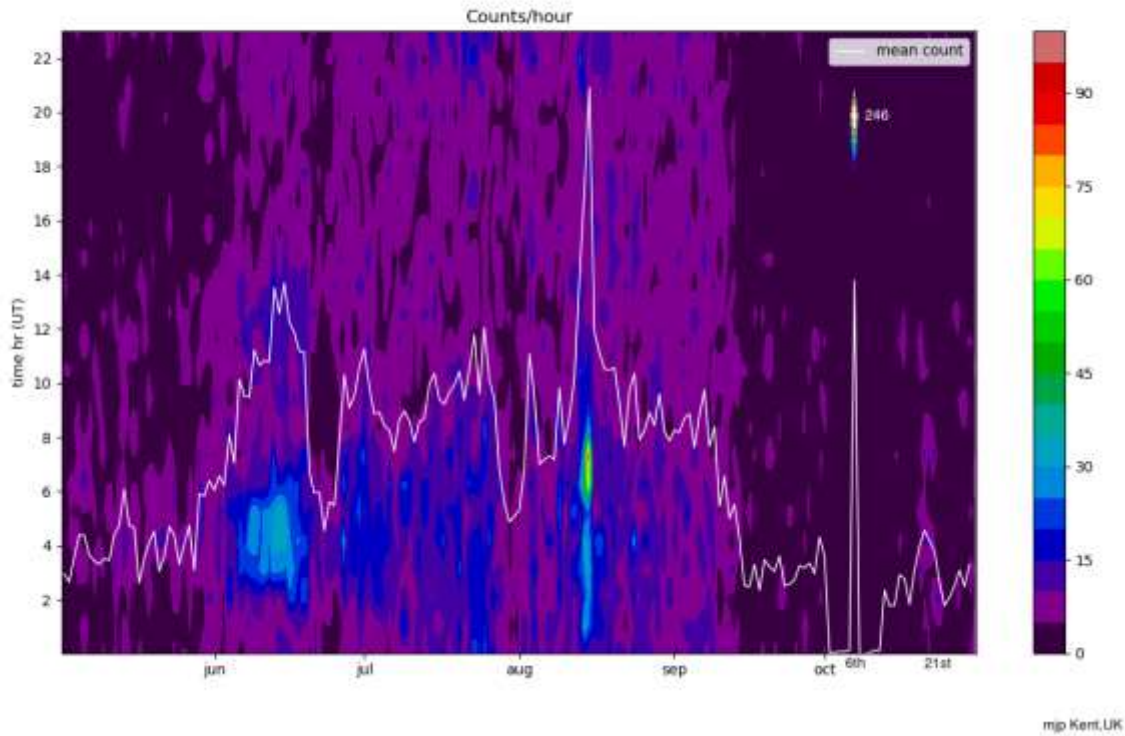

Mark has also been experimenting with ways of presenting meteor echo activity. The aim of this chart is to identify patterns in the periodicity (in days) of meteor echoes from the mean counts.



## SOLAR RADIO BURSTS

Colin Briden recorded just one solar radio burst in November. This chart shows a type III/1 burst recorded at 11:01UT on November 1<sup>st</sup> at 28MHz.

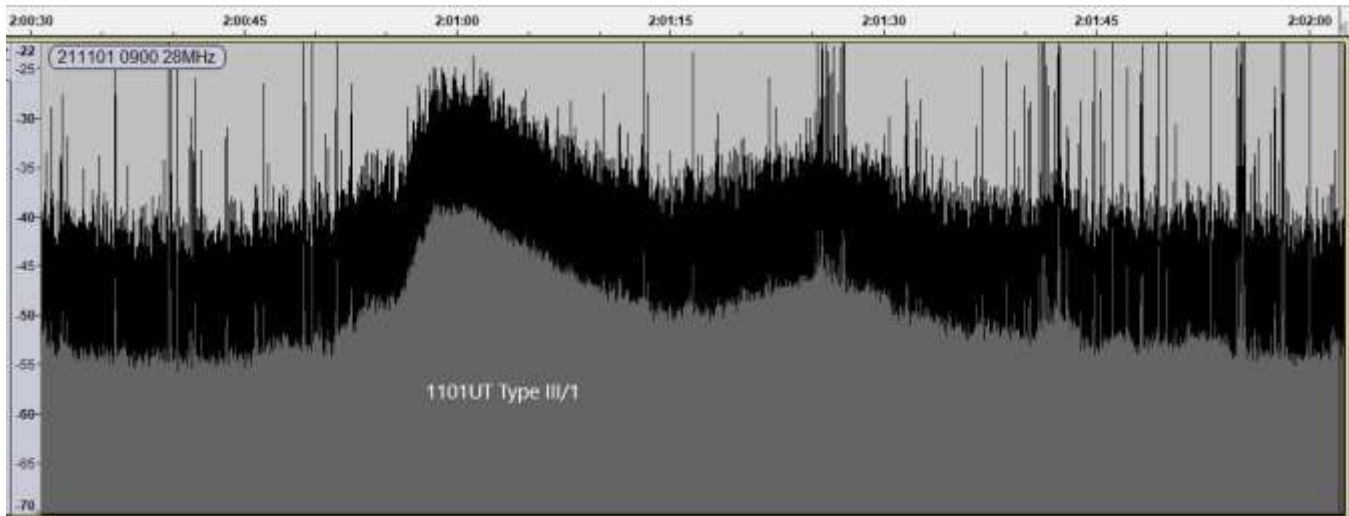

The black lines show the signal peaks, while the grey area is the smoothed data. This is timed nearly 10 hours after the M1.5 flare, so any link is not clear.

Colin has also been working on monitoring VLF discrete emissions, although a very low SNR is making it difficult to show them on charts. In 32 hours of day-time recording, 171 events were detected in the range 1.5 to 4.0kHz. Occasional prolonged 'chatter' was seen around 4.5kHz, with a short period of auroral chorus around 16:10UT on the 30<sup>th</sup> at 1.3kHz.

DAY	Xray class	Observers	John Cook (23.4kHz/22.7kHz)	Roberto Battaglia (20.9kHz)	Paul Hyde (22.1kHz/24kHz)	Mark Edwards (24.0kHz/18.3kHz)	Colin Clements (23.4kHz/18.3kHz)
			Tuned radio frequency receiver, 0.5m frame aerial.	Modified AAVSO receiver.	Spectrum Lab / PC 1.5m frame aerial.	Spectrum Lab / PC 2m loop aerial.	Tuned Radio Frequency receivers, 0.75m screened loop aerial.
			START PEAK END (UT)	START PEAK END (UT)	START PEAK END (UT)	START PEAK END (UT)	START PEAK END (UT)
4	C3.5	3	10:47 10:53 11:04 1-			10:45 10:55 11:19 2	
4	C2.9	1				14:47 14:58 15:11 1	
13	C1.2	1				08:38 08:45 08:49 1-	

DAY	Xray class	Observers	Steve Parkinson (Various)	Andrew Thomas (23.4kHz)	Phil Rourke (23.4kHz)	John Wardle	Christopher Bailey
			Tuned radio frequency receiver, frame aeriels.	Tuned radio frequency receiver, 0.6m frame aerial.	Spectrum Lab, 0.6m frame aerial.	SpectrumLab/Starbase, Active mini-whip aerial.	Spectrum Lab
			START PEAK END (UT)	START PEAK END (UT)	START PEAK END (UT)	START PEAK END (UT)	START PEAK END (UT)
4	C3.5						
4	C2.9						
13	C1.2						

DAY	Xray class	Observers	Colin Briden (22.1kHz)	Andrew Lutley (23.4kHz)	Peter Meadows (23.4kHz)	John Elliott (18.3kHz)	Mark Prescott (22.1kHz)
			Spectrum Lab / PC, 1.2m frame aerial.	Tuned radio frequency receiver, 0.6m frame aerial.	Tuned radio frequency receiver, 0.6m frame aerial.	Tuned radio frequency receiver, 0.5m frame aerial.	
			START PEAK END (UT)	START PEAK END (UT)	START PEAK END (UT)	START PEAK END (UT)	START PEAK END (UT)
4	C3.5						10:49 10:59 11:12 1.
4	C2.9						
13	C1.2						

Our programme of virtual meetings and seminars continues to be very well received, and my thanks go to Paul Hearn for organising them, and all those providing material. An archive of 2021 meetings can be found at <https://britastro.org/node/25798>. Several meetings are already planned for 2022, the following programme to start the year:

- ☼ 2022 January 7<sup>th</sup>: 19:30gmt 'CHIME' Magnetars and fast radio bursts' by Alexander Josephy.
- ☼ 2022 January 15<sup>th</sup> 14:00gmt 'GNU II training seminar' with Marcus Leach.
- ☼ 2022 February 4<sup>th</sup>: 19:30gmt 'VHF meteor observations, the IMO, and correlation.' by Chris Steyaert.

My thanks to everyone for providing reports and observations for the monthly summary, and best wishes for a Happy and Healthy Christmas.

---

## BAA Radio Astronomy Section

2021 DECEMBER

There was a significant increase in solar activity in December as a number of more complex active regions developed. The satellite X-ray data shows a total of eight M-class flares, four of which we were lucky to record as SIDs. The day length in December is at its shortest, and with the sun very low in the sky, VLF signals can become very noisy and difficult to interpret. The first of these was the M1.4 on the 5<sup>th</sup>. This was early in the morning here in the UK, peaking at 07:26UT, but was recorded by Roberto Battaiola in Milan. Being further South and East has the advantage of an earlier sunrise relative to Universal Time.

The C8.1 flare peaking at 10:44UT on the 15<sup>th</sup> was better timed and more widely recorded. This chart by Paul Hyde shows a clear mixture of upright and inverted SIDs, although the 20.9kHz signal from France is less clear:

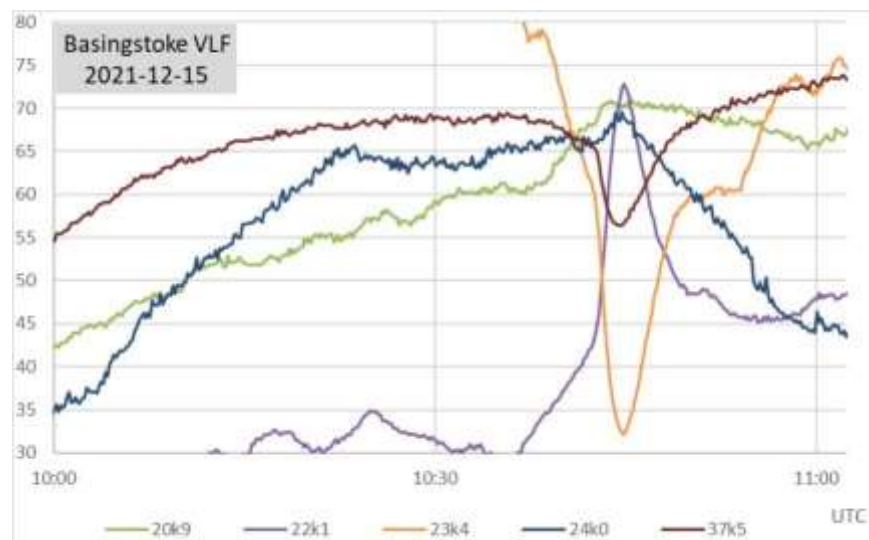

This was the start of a period of high solar activity, with plenty of sunspots visible. Many of these were fairly large and complex, although mostly producing smaller C-class flares. These were difficult to detect on the often very noisy VLF signals at this time of year. A number of the signals were also switched off for periods over the Christmas holiday. The 20<sup>th</sup>, 21<sup>st</sup> and 22<sup>nd</sup> all saw some good M-class flares, starting with the M1.8 peaking at 11:35 on the 20<sup>th</sup>. This was recorded by Mark Edwards:

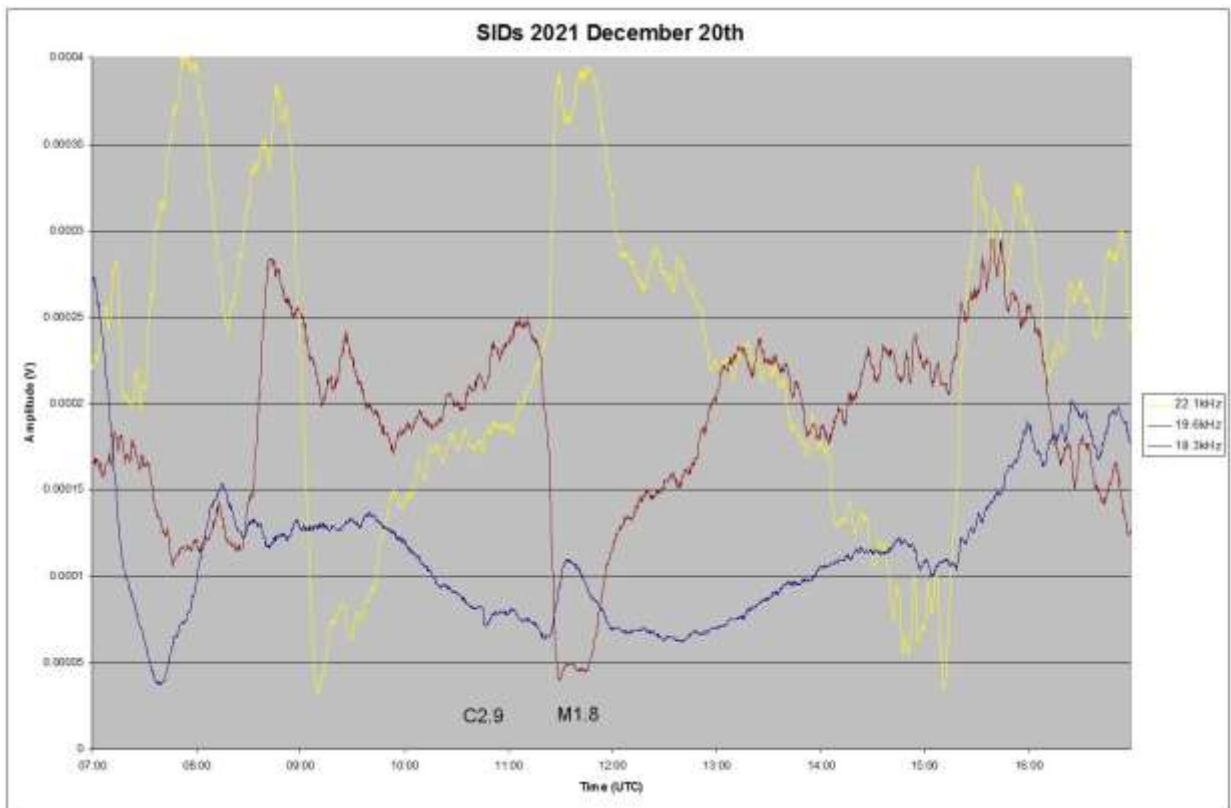

The smaller C2.9 flare is also visible on the 18.3kHz signal (blue trace) with a small drop in signal strength, while the M1.8 flare has produced an increase in signal strength. A small phase inversion is visible on both the 22.1 (yellow) and 19.6kHz (brown) signals.

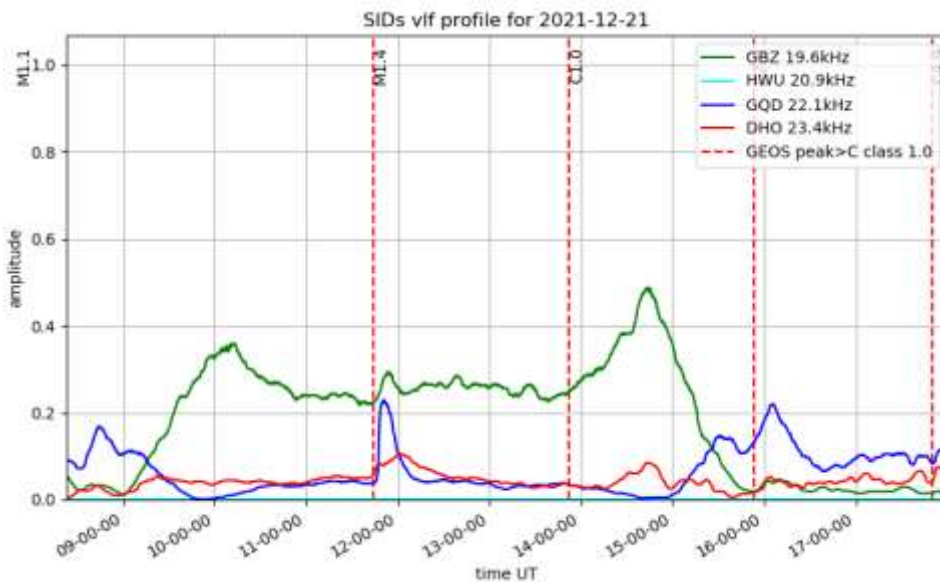

Mark Prescott made this recording of the M1.4 flare peaking at 11:48 on the 21<sup>st</sup>. Chris has added markers for the flares, although the three later ones have not recorded. The 19.6 kHz signal also shows just how long the sunset and sunset disturbances last on the winter solstice.

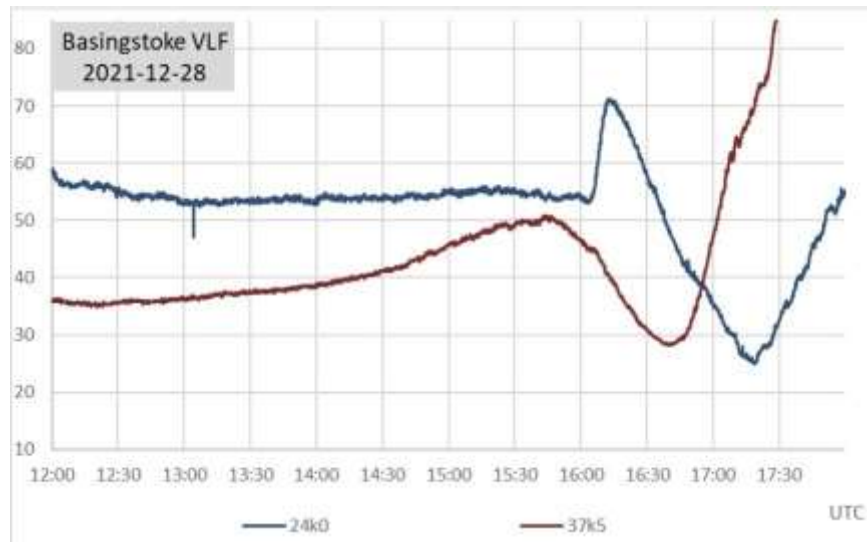

The M1.6 flare on the 28 was quite late, peaking at 16:14UT, but has produced clear SIDs on the longer western paths at 24.0 and 37.5kHz, shown here recorded by Paul Hyde.

Mark Edwards has provided his annual chart of D-region heights through the year, based on his 19.6 and 22.1kHz signal measurements. The red line marks the measured data points, and the green curve is the model output.

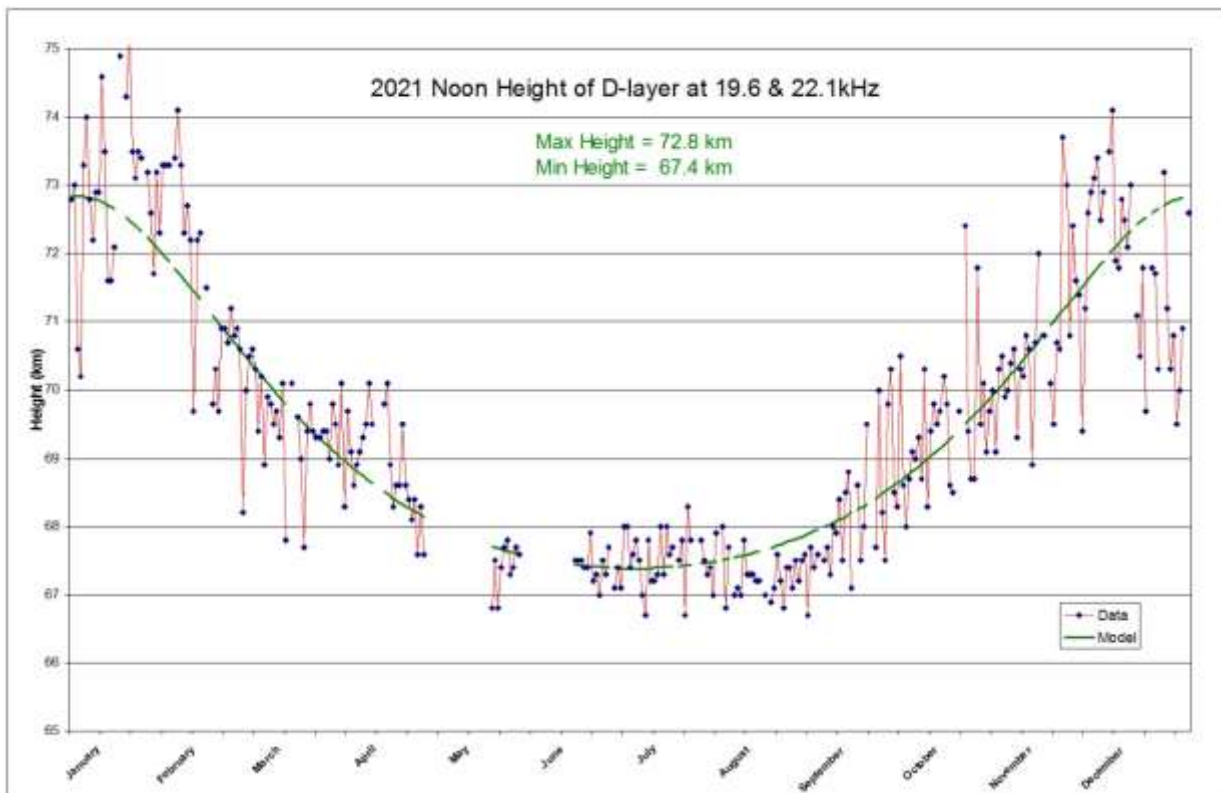

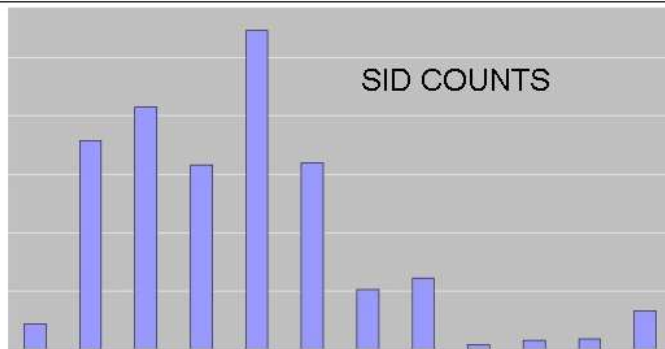
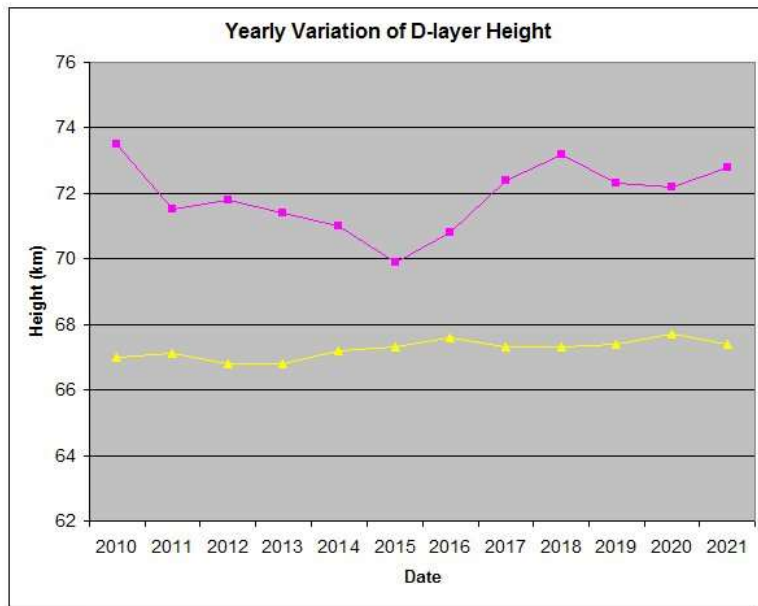

The upper part of this chart shows how maximum and minimum heights have varied over the last 12 years, the lower part showing the year's total SID count from our recordings. The minimum height shows only a small variation, while the maximum is much more variable. The maximum height appears to reduce as cycle 24 reaches its peak, and then increases again as it reaches minimum. Cycle 25 is now well underway, with the maximum height starting to rise this time.

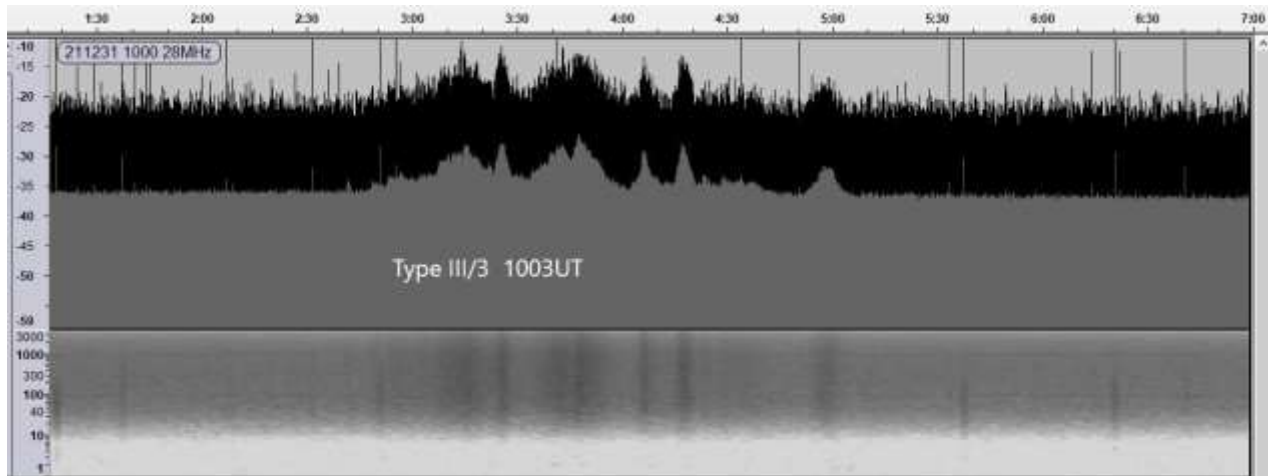



Colin Briden recorded this type III/3 pulsing radio burst on 28MHz. The chart starts at 10:00 on the 31<sup>st</sup>, with the burst starting at 10:03, lasting for about 2 minutes. There was a small B4.6 flare at this time.

There had been some significant interference preventing recordings earlier in the month, but it had stopped in time for this one to be caught.

### MAGNETIC OBSERVATIONS

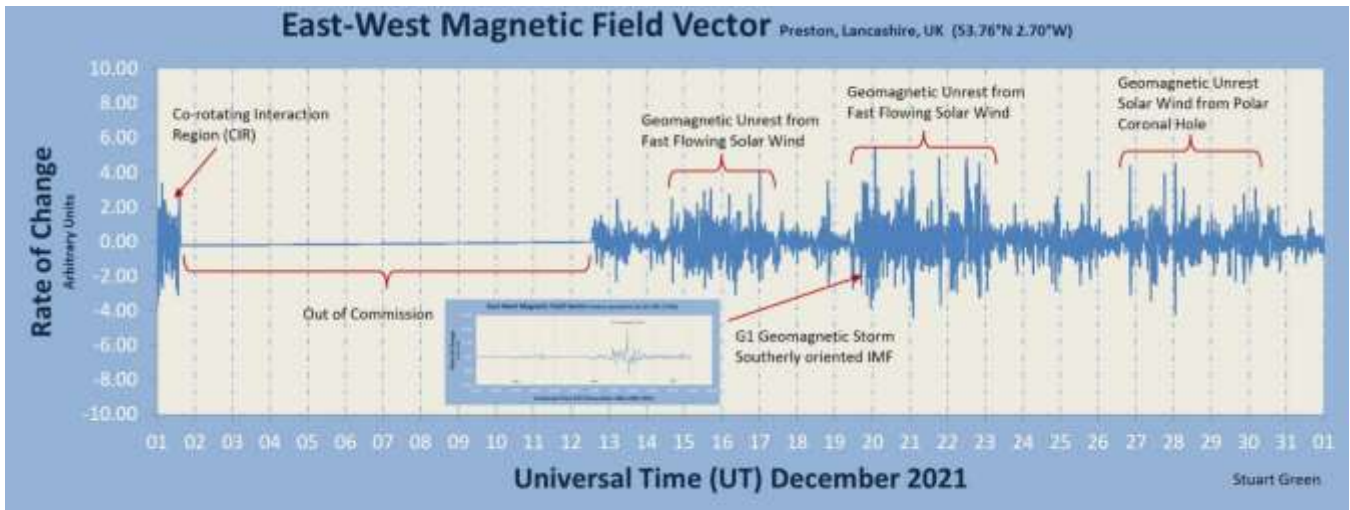

Stuart Green has provided the month's summary of geomagnetic activity. Equipment problems meant that no recordings were possible early in the month, but there is still plenty of activity shown. The increased solar wind seen at the end of November continued into December, aided by a CHSS on the 4<sup>th</sup> and 5<sup>th</sup>. This recording by Colin Clements is from the 2<sup>nd</sup>:

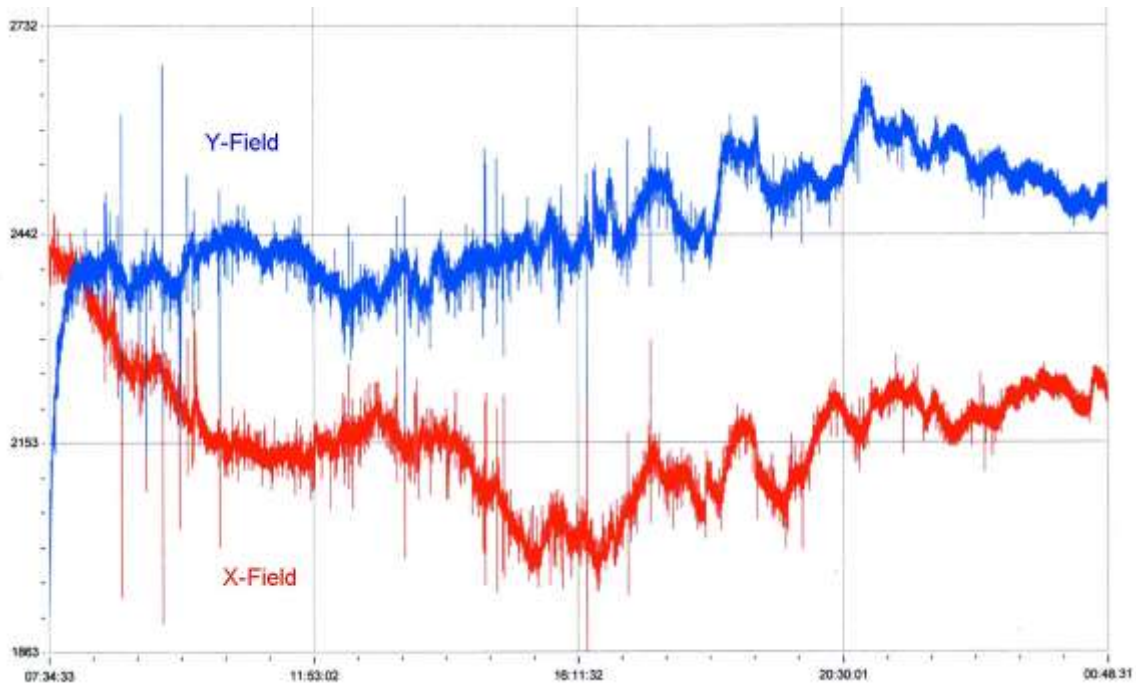

The majority of the month's activity was from high speed solar winds, with a very mild disturbance overnight on the 15<sup>th</sup> and 16<sup>th</sup>. There was a much stronger disturbance recorded starting on the 19<sup>th</sup>, shown in this recording by Callum Potter:

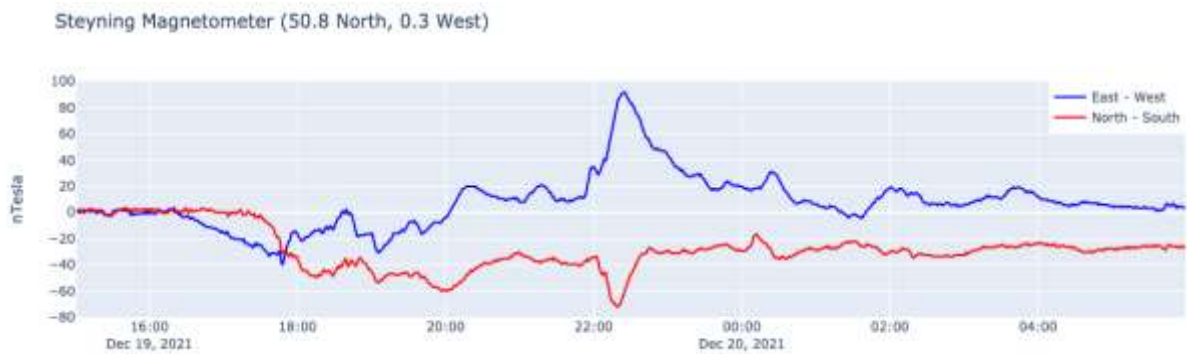
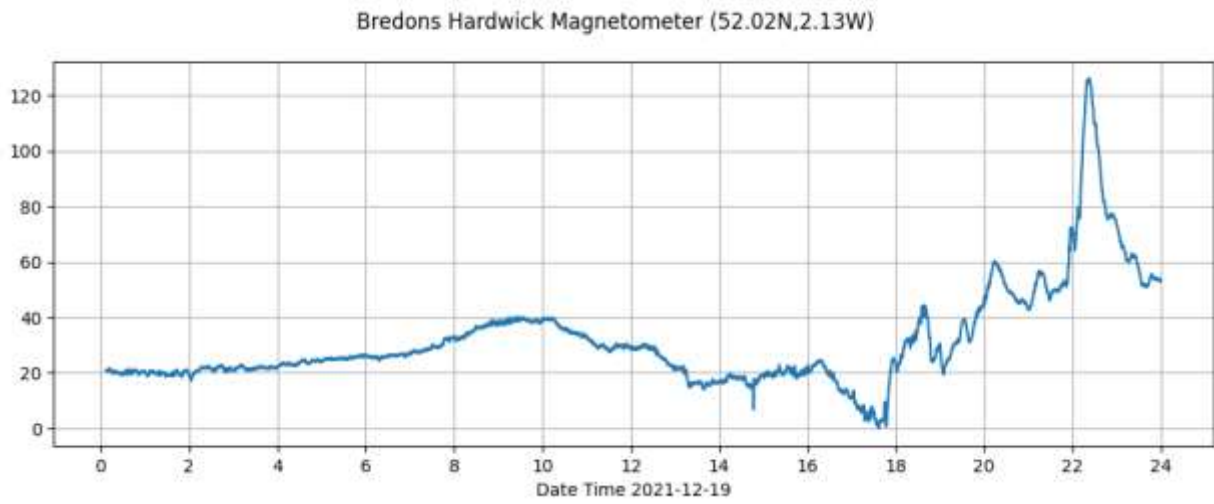

The recording by Nick Quinn (above) shows the activity fading out early in the morning on the 20<sup>th</sup>. Both recordings show the more active period lasting just over an hour from 22UT on the 19<sup>th</sup>. Short periods of very mild disturbance continued over the next couple of days.

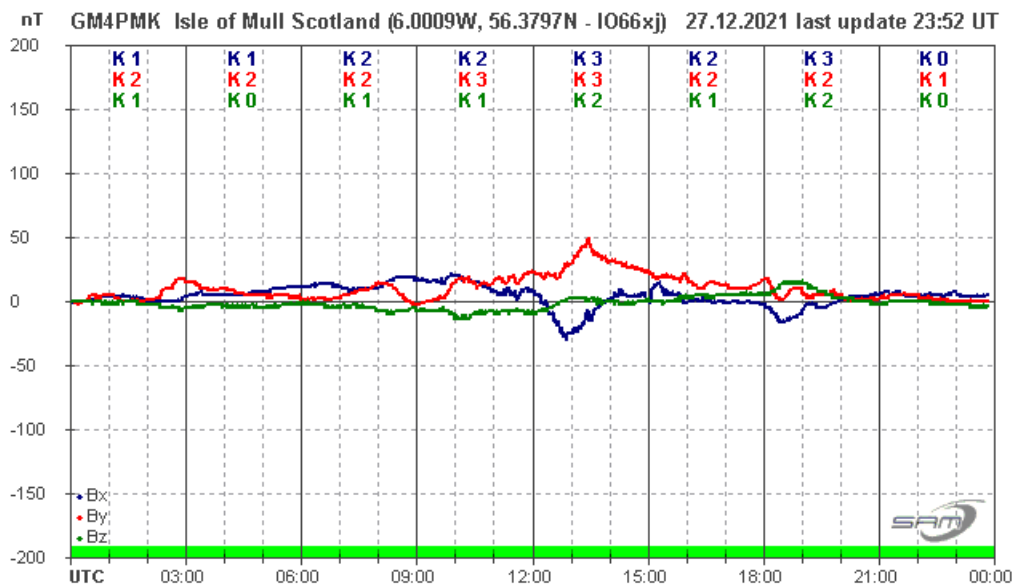

This mild disturbance on the 27<sup>th</sup> recorded by Roger Blackwell was again from a high speed solar wind, probably from a polar coronal hole.

Magnetic observations received from Roger Blackwell, Colin Clements, Stuart Green, Callum Potter, Nick Quinn and John Cook.

### METEOR OBSERVATIONS

Meteor echoes (GRAVES radar) mean counts 2020 and 2021

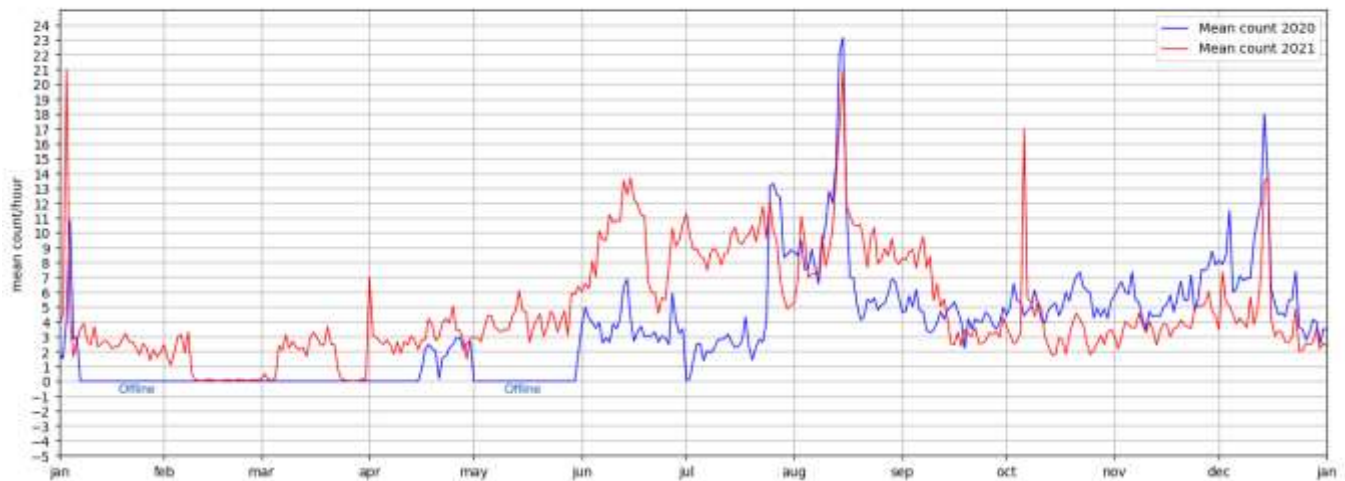

Mark Prescott has made a comparison of meteor echoes recorded using the GRAVES signal in 2020 and 2021. Recordings were not made for the first half of 2020 (blue trace), but the August Perseid and December Geminids and Ursids are clear. The 2021 recording also show a strong October Orionid peak. The 2021 data also shows a broad peak in echo numbers through the middle of June and early July, potentially observation of the Daytime zeta-Perseids and/or Daytime Arietids. These are noted as good for radio observers in the 2021 BAA Handbook meteor diary. Mean counts through the summer months certainly seem to be generally higher in 2021.



DAY	X-ray class	Observers	John Cook (23.4kHz/22.7kHz)	Roberto Battaglia 20.3kHz	Paul Hyde (22.1kHz/24kHz)	Mark Edwards (24.0kHz/18.3kHz)	Colin Clements (23.4kHz/18.3kHz)
			Tuned radio frequency receiver, 0.58m frame aerial.	Modified AAVSO receiver.	Spectrum Lab / PC 1.5m frame aerial.	Spectrum Lab / PC 2m loop aerial.	Tuned Radio Frequency receivers, 0.76m screened loop aerial.
			START PEAK END (UT)	START PEAK END (UT)	START PEAK END (UT)	START PEAK END (UT)	START PEAK END (UT)
5	<b>M1.4</b>	1		07:18 07:26 07:37 1			
15	C8.1	10	10:42 10:44 10:52 1-	10:31 10:44 11:04 2	10:42 10:45 10:53 1-	10:41 10:44 10:48 1-	10:42 10:46 10:49 1-
15	C2.6	3		12:09 12:14 12:25 1-			12:15 12:17 12:21 1-
15	C4.4	5		14:28 14:34 14:42 1-		14:33 14:35 14:48 1-	
16	C2.0	1				13:36 13:41 13:47 1-	
16	C3.3	1				15:26 15:29 15:36 1-	
17	C2.3	2		12:56 13:10 13:25 1+		13:02 13:09 13:21 1	
20	C2.9	1				10:46 10:47 10:52 1-	
20	<b>M1.8</b>	8	11:25 11:33 11:49 1		11:23 11:33 12:02 2	11:24 11:35 12:00 2	
21	<b>M1.4</b>	8	11:40 11:45 11:55 1-	11:29 11:39 11:53 1	11:39 11:45 12:10 1+		
22	<b>M1.3</b>	1					
22	C3.4	1		10:14 10:18 10:25 1-			
22	C8.8	1					
24	C4.2	1		10:07 10:16 10:49 2			
24	C5.2	2		11:35 12:10 12:41 2+			
25	C2.2	1		09:47 09:53 10:02 1-			
25	C3.0	4		12:18 12:23 12:26 1-	12:22 12:26 12:39 1-		
25	C3.3	2		13:19 13:30 13:37 1-			
28	<b>M1.6</b>	1			16:04 16:14 16:50 2+		

DAY	X-ray class	Observers	Steve Parkinson (Various)	Andrew Thomas (16.3kHz)	Phil Rourke (23.4kHz)	John Wardle	Christopher Bailey
			Tuned radio frequency receiver, frame aeriels.	Tuned radio frequency receiver, 0.6m frame aerial.	Spectrum Lab, 0.6m frame aerial.	SpectrumLab/Starbase, Active mini-whip aerial.	Spectrum Lab
			START PEAK END (UT)	START PEAK END (UT)	START PEAK END (UT)	START PEAK END (UT)	START PEAK END (UT)
5	<b>M1.4</b>	1					
15	C8.1	10	10:42 10:44 10:50 1-	10:36 10:44 10:55 1			10:36 10:45 10:53 1-
15	C2.6	3					
15	C4.4	5					14:33 14:36 14:41 1-
16	C2.0	1					
16	C3.3	1					
17	C2.3	2					
20	C2.9	1					
20	<b>M1.8</b>	8	11:18 11:33 11:55 2	11:10 11:33 12:11 2+			11:17 11:35 12:15 2+
21	<b>M1.4</b>	8	11:42 11:45 12:04 1	11:38 11:54 12:22 2			11:43 11:48 12:18 2
22	<b>M1.3</b>	1					06:52 07:04 07:38 2+
22	C3.4	1					
22	C8.8	1					18:07 18:12 18:20 1-
24	C4.2	1					
24	C5.2	2		11:46 12:02 12:33 2+			
25	C2.2	1					
25	C3.0	4		12:21 12:25 12:43 1			
25	C3.3	2					
28	<b>M1.6</b>	1					

DAY	X-ray class	Observers	Colin Bnden (22.1kHz)	Andrew Lutley (23.4kHz)	Peter Meadows (23.4kHz)	John Elliott (18.3kHz)	Mark Prescott (19.6/23.4/20.9kHz)
			Spectrum Lab / PC, 1.2m frame aerial.	Tuned radio frequency receiver, 0.6m frame aerial.	Tuned radio frequency receiver, 0.6m frame aerial.	Tuned radio frequency receiver, 0.5m frame aerial.	
			START PEAK END (UT)	START PEAK END (UT)	START PEAK END (UT)	START PEAK END (UT)	START PEAK END (UT)
5	<b>M1.4</b>	1					
15	C8.1	10	10:42 10:45 10:47 1-				10:45 10:48 10:53 1-
15	C2.6	3					12:13 12:18 12:26 1-
15	C4.4	5	14:32 14:35 14:39 1-				<del>14:34</del> 14:39 14:44 1-
16	C2.0	1					
16	C3.3	1					
17	C2.3	2					
20	C2.9	1					
20	<b>M1.8</b>	8	11:17 11:33 12:00 2				11:29 11:42 12:04 2
21	<b>M1.4</b>	8	11:41 11:46 11:56 1-				11:44 11:53 12:04 1
22	<b>M1.3</b>	1					
22	C3.4	1					
22	C8.8	1					
24	C4.2	1					
24	C5.2	2					
25	C2.2	1					
25	C3.0	4	12:22 12:25 12:27 1-				
25	C3.3	2	13:27 13:31 13:34 1-				
28	<b>M1.6</b>	1					

### VLF flare activity 2005/21

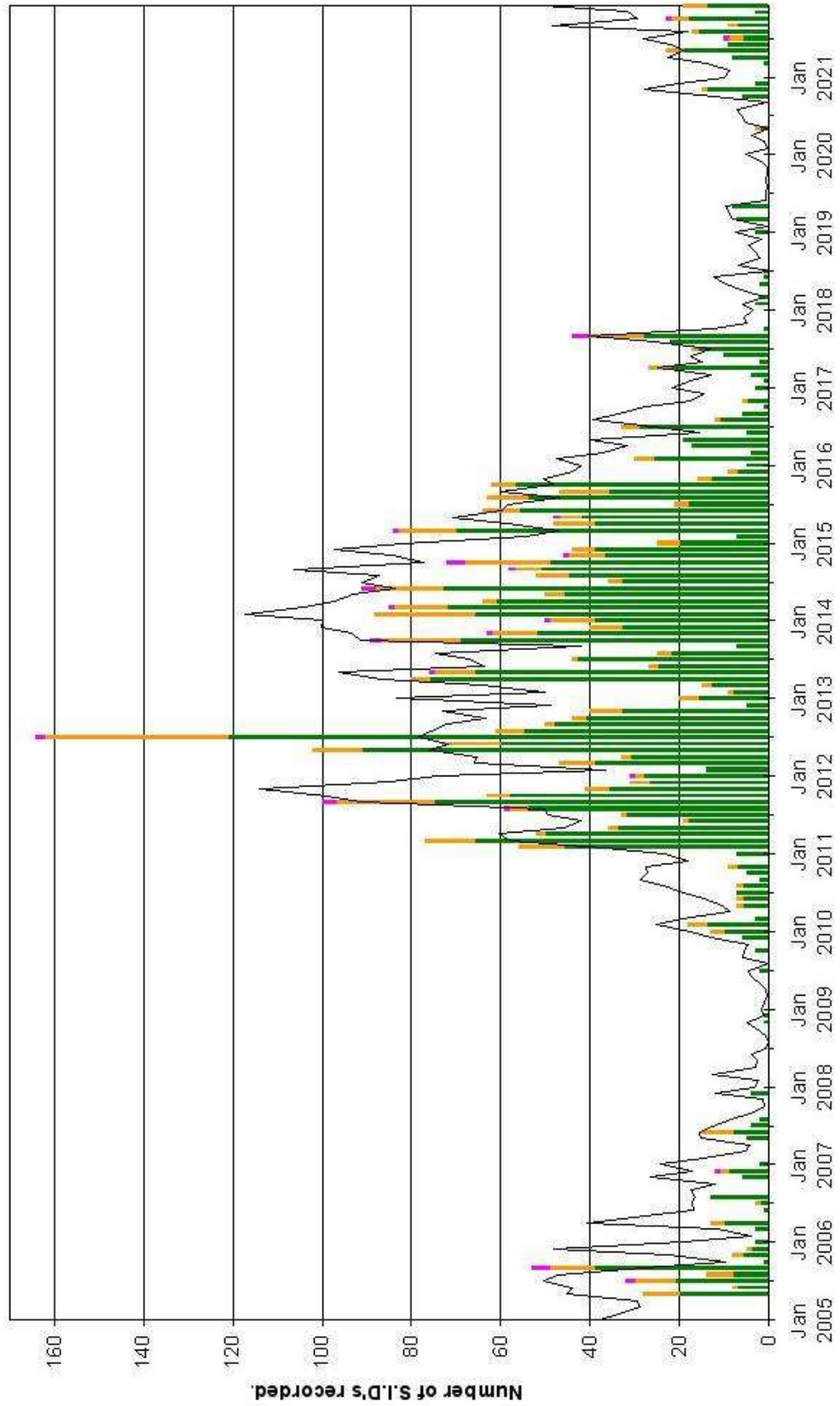
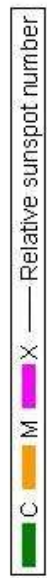

Bartels Diagram





## British Astronomical Association

Supporting amateur astronomers since 1890

### Radio Astronomy Section

#### BAA RA Section Summer programme 2022

May 6th. 19:30 BST (18:30 UTC)	Professor Lea Thompson Department of Physics and Astronomy. University of Sheffield	<b>'muons; Detection, Cosmology, Tomography, Navigation and Civil Engineering'.</b>
June 3rd . 19:30 BST (18:30 UTC)	Dr. Leah Morabito UKRI Future Leaders Fellow and Asst Prof Durham University	<b>'LOFAR: how high-resolution radio observations can help us understand supermassive black holes'</b>
July 1st . 19:30 BST (18:30 UTC)	Prof. Jim Madsen Executive Director Wisconsin IceCube Particle Astrophysics Centre. (WIPAC)	<b>'Cosmic neutrinos – messengers from the cosmos arriving in Antarctica'.</b>

If you have any suggestions for the winter 2022 term do let me know. Our meetings are open to all. Once you are registered on the RA Section email list the Zoom link will be sent out to you before the meeting. If you are not on the email list, please request registration from Paul Hearn RA Section Director ( [paul@hearn.org.uk](mailto:paul@hearn.org.uk) ). All recordings will be posted on our BAA YouTube channel.

<https://www.youtube.com/user/britishastronomical/playlist>

### Getting the Best out of PRESTO - Part 4: Dispersion Search Discrimination Peter East

#### Abstract

The dispersion measure (DM) search plot produced by PRESTO is probably its most important pulsar validation indicator since it can clearly confirm the correct value for the extra-terrestrial source [1,2]. For low signal-to-noise ratio observations the discrimination may not be sufficiently convincing. It has been shown however, that using signal-to-noise ratio (SNR) measure, rather than Chi-square statistic for amplitude sensing, usefully improves DM search discrimination [3]. This article explores a simple technique for further improving DM discrimination and validation confidence by isolating the target pulsar contribution from other random background folded noise peaks.

#### Introduction

Examining the dispersion characteristic of pulsar candidates in amateur data is an important part of the validation process. With strong signals the professional PRESTO software DM search measure is clear but with weaker signals this is not always so. In fact, below an integrated SNR of about 12:1, the PRESTO *prepfold* output DM plot is often inconclusive. To be fair, PRESTO was designed by professional radio astronomers to detect new pulsars and so is not optimum for validating amateur's weaker detections.

This article follows previous papers recommending peak SNR searching [3,4,5]. It shows that a stronger DM indicator is obtained by comparing the peak SNR search process with a similar search with the pulsar candidate blanked, so isolating the pulsar candidate DM contribution. The solution can be shown to reject folded noise peaks and interference spikes.

Section 1 describes the background principles and examines the ruggedness of the approach by adapting weaker sections of the recorded data to both improve and degrade the candidate final folded SNR.

Section 2 offers some results based on PRESTO-type plots and sub-plots of the three cases for comparison of the usual PRESTO validation features. No method is infallible and for the final result a noise-only example has been handpicked that shows up the limitations of basic pulsar validation schemes.

Section 3 summarizes the developments described.

#### Section 1. Dispersion Search Discrimination

##### Pulsar Dispersion

Broadband pulsar signals propagating the interstellar medium interact with free electrons to lower its group velocity, effectively delaying the lower frequency components. For a given pulsar radio frequency and RF band, it is convenient to describe the band dispersion as the dispersion in ms/MHz bandwidth as a function of the RF centre frequency  $f_0$  (in MHz). For the RF band and receiver bandwidth chosen, dispersion time  $t_d$  is calculated from,

$$t_d = 8.3 \cdot DM \cdot \left( \frac{1}{f_0^3} \right) \cdot 10^6 \text{ ms / MHz} \quad (1)$$

$DM$  is the catalogued pulsar dispersion measure (= 26.7 for B0329+54).

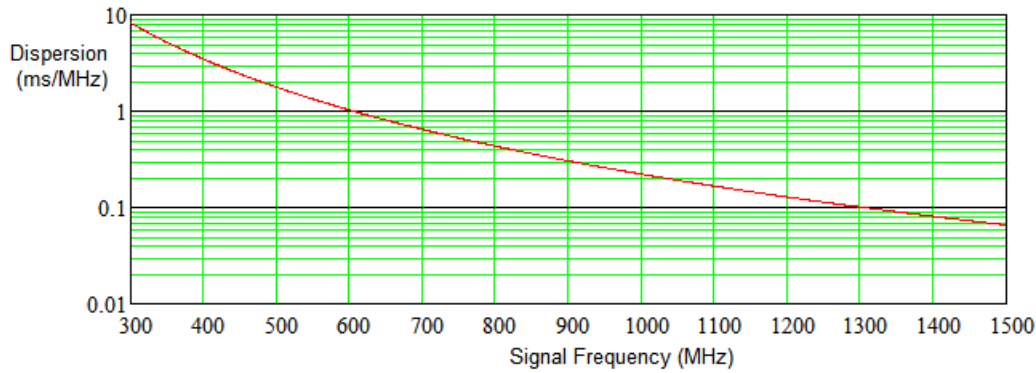

**Figure 1.** B0329 Dispersion in ms/MHz RF Bandwidth

Figure 1 plots the dispersion for B0329 as a function of radio frequency showing the cubic dependency. In practice, for RF bandwidths below 10 MHz, the local slope can be approximated by its mean value, calculated at the RF band center frequency without any significant reduction in de-dispersion accuracy.

At 610 MHz the slope is close to 1 ms/MHz for  $DM = 26.7$  but at 400 MHz the dispersion slope rises to approximately 3.5 ms/MHz. These figures are applied in the relevant bands in the de-dispersion process.

The effect of dispersion is to reduce the pulse amplitude and broaden the observed (folded) pulse width due to the lower frequencies natural delay. Modeling, using a Gaussian target pulse shape as a function of time,  $P(t)$ , the pulse amplitude and broadening can be analyzed from the mean pulse response in a period,

$$P(t) = \frac{1}{Nf} \sum_{n=-\frac{Nf}{2}}^{\frac{Nf}{2}} A(n) \exp \left( -4 \ln(2) \left[ \frac{\left( t - t_0 + \frac{n}{Nf} d \right)^2}{W} \right] \right) \quad (2)$$

where,

$Nf$  is the number of RF sub-bands.

$n$  is the sub-band number.

$A(n)$  is the average pulse amplitude in sub-band  $n$ .

$d$  is the test dispersion in ms in searching across the pulse response.

$t_0$  is the pulse center time-of-arrival.

$W$  is the pulsar pulse half-height width in ms.



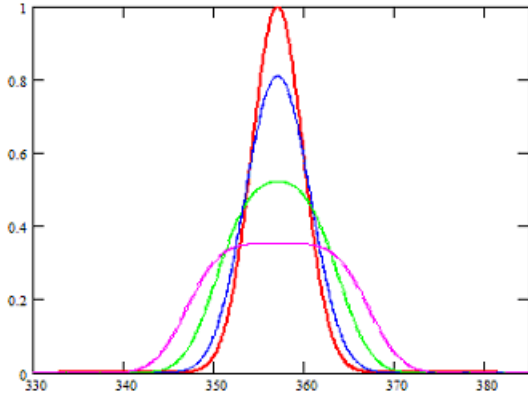

**Figure 2.** Dispersion Search Effects,  $d/W = 0, \pm 1, \pm 2, \pm 3$  (red, blue, green, magenta)

Figure 2 illustrates the effect of dispersion on the folded pulse. If the dispersion ( $t_d \times \text{Bandwidth}$  from Equation 2) equals twice the pulse duration, then the folded pulse amplitude (green curve) drops to about one half and the folded pulse width is approximately doubled. In practice, for weaker signals, due to RF scintillation, the underlying noise and a using only few bands, the Figure 2 plots will be distorted, but the general features predicted will be there as shown in Figure 3. Note that noise peaks may change in amplitude and position but do not follow the pattern of a regular pulse train.

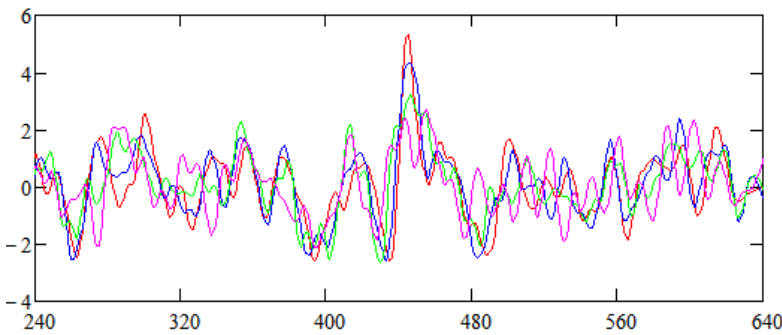
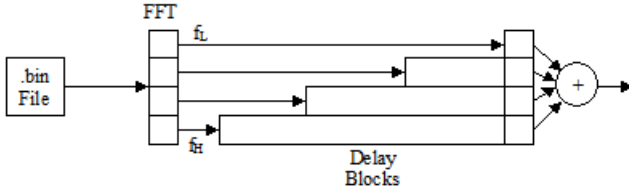

**Figure 3.** 5.5:1 SNR B0328 Data Dispersion Search Fold,  $d/W = 0, \pm 1, \pm 2, \pm 3$ .

Continuing the 610MHz RF and 10MHz bandwidth example, the propagation dispersion across the band is calculated as approximately 10ms; so for the B0329 pulsar with 6.5ms pulse width, we can expect the non-de-dispersed folded pulse peak to be reduced in amplitude by about one third compared with the correctly de-dispersed result, proving that proper de-dispersion, for 600MHz and below, is a worthwhile exercise.

### Practical De-dispersion and Dispersion Search

Data de-dispersion involves separating the received signal bandwidth into a number of sub-bands and delaying the higher sub-bands before video or digital summing to compensate for the interstellar delays. De-dispersion can be carried out at any multi-band stage, including after the channeled data has been separately folded, provided the number of fold bins is adequate for the accuracy required.

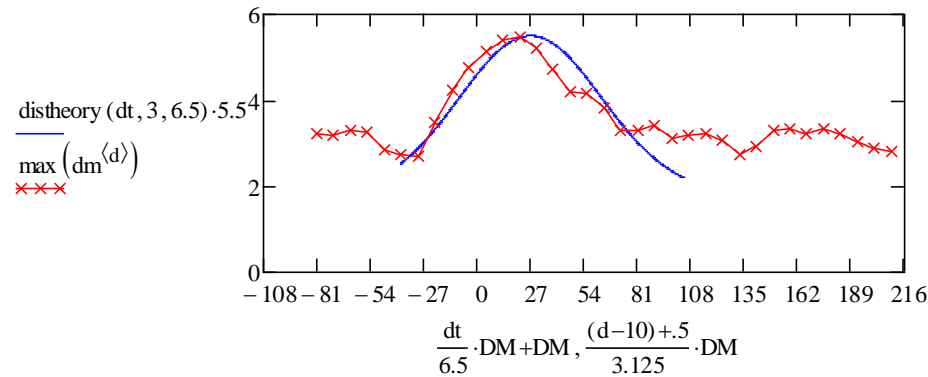

**Figure 4.** De-dispersion Principle

The principle of de-dispersion is illustrated in Figure 4.

This indicates, using an FFT to divide the raw data band, how the higher frequency components ( $f_H$ ) are delayed to match the low frequency ( $f_L$ ) component arrival times and so sum powers to optimize the received SNR. Typically, the data form required for amateur de-dispersion is in multi-band downsampled data samples at rates typically 0.5 to 2 kbps. Using an FFT for band division, the number of frequency channels is usually from 3 to 32 but in this note the investigation is restricted to 3 bands at 1 kbps.

For dispersion measure search, the band delays are varied linearly over a range to accomplish both positive and negative dispersions; the combined data SNR is then calculated to produce a plot similar to the red crossed plot in Figure 5. The blue curve plots the expected folded pulse amplitude using Equation 2 with  $t_0 = 0$ ,  $Nf = 3$ ,  $W = 6.5$  ms and  $d$  in steps of 1 ms.



**Figure 5.** B0329 Dispersion Measure Search. red - Measured Peak Data; blue - Gaussian Pulse Theory

The 10 MHz measurement band was originally divided into 16 bands but since band zero was corrupt, it was ignored and the remaining band of 9.375 MHz was divided into 3 bands approximately 3.125 MHz each (this figure is used in Figure 5 for conversion of ms delay  $d$  values to  $DM$ ).

In this SNR = 5.5:1 example, the function used to produce the red curve in Figure 5 is listed in Equation 3.  $V1, V2$ , and  $V3$  are the 3 sub-band folded resultants; each folded into  $K = 714$  bins.  $q$  is the bin number variable and  $d$  the inter-band delay variable. The delay variable is offset by  $d = 10$  ms to allow for negative  $DM$  values.

$$dm_{q,d} := V1_{\text{mod}(q+K+10-d, K)} + V2_{\text{mod}(q, K)} + V3_{\text{mod}(q+K-10+d, K)} \quad (3)$$

(Note: the *mod* function cycles the data delay variable subscript, ( $q+...$ ) with the period  $K$ ).

For each value of the delay variable  $d$ , the combined folded data was scanned and the maximum recorded for the plot. With 714 bins, and approximately 714.5 ms B0329 pulsar period, each bin represents approximately 1 ms so

it is relatively easy to convert the delay variable  $d$  to equivalent DM value. It is noted that the center band V2 is unmodified ensuring that the pulsar pulse peak position is unchanged with the dispersion variable  $d$ .

Note that the red data plot in Figure 5 peaks close to the expected DM = 26.7 value for B0329 and has a reasonable match to the theoretical shape. Some distortion is expected at this low SNR value due to the influence of the background noise. Outside the peak, the maximum amplitude falls due to the pulse position spread and appears to settle around an equivalent SNR of about 3.5. This is higher than expected for natural noise peaks and is due to using only 3 bands, where for an SNR of 5.5, the average band SNR expected is  $5.5/\sqrt{3} = 3.2:1$ . The most important verification indicator is the search peak being close to the expected DM value of 26.7.

It seems from Figure 6 that the largest fold peak candidate passes the DM search test. Incidentally, it also passes the pulse width and TEMPO topocentric period matching tests.

From the folded data plot in Figure 6, the pulse candidate appears at bin 445. However, the DM search amplitude discrimination in Figure 5 is not all that great ( $5.5/3.5 = 1.6:1$ ) and is expected to degrade for lower SNR intercepted observations.

For reference, Figure 6 plots the example's raw folded SNR results for the 3-band data and (below) their de-dispersed sum.

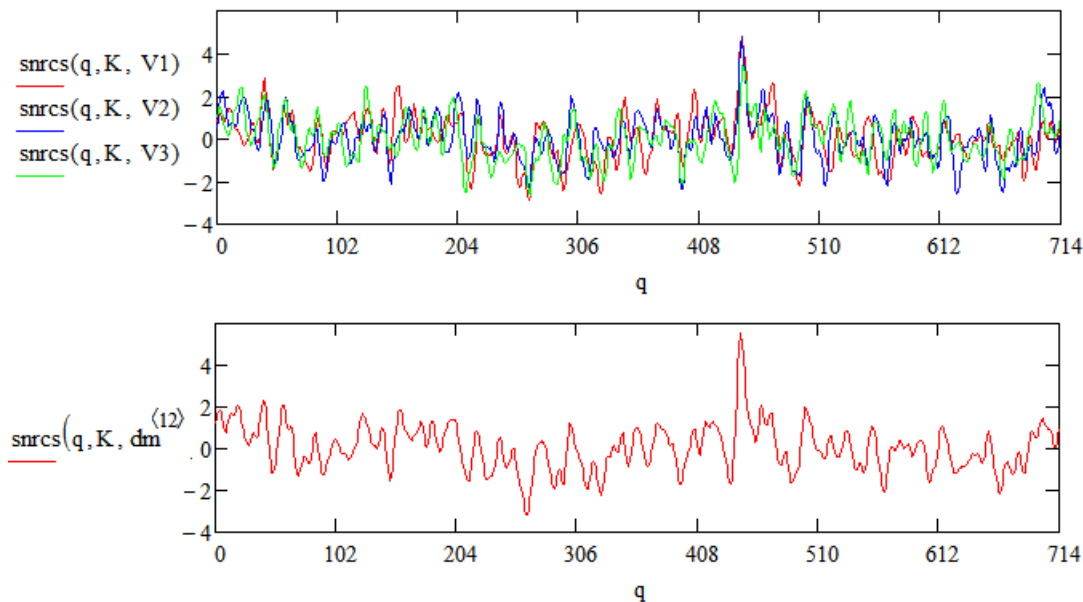

**Figure 6.** B0329 Folded Data. Upper: Band folded results; Lower De-dispersed Full Result (SNR = 5.5:1)

Viewing the upper plot in Figure 6, there is a useful pulsar signal response at bin 445 in all bands but some obvious correlation exists between the base noises of the three plots, together with some low frequency mean drift. Both these latter issues, probably attributable to the power supply, can be mitigated and so improve the summed resulting SNR. This has not been done for this exercise but for information, with optimal peak/spur thresholding, the non de-dispersed sum SNR increased from 5.1:1 to 5.5:1.

### Sub-band Choice

For the tests described in this note, the measurement band data was divided into just three bands, for convenience of this description and analysis. Five-band division and seven-band division was also evaluated (see Appendix 1) together with increasing the time delay resolution from 1 ms to 0.5 ms.

Some improvement was noted in these cases, mainly in the search scan peak moving closer to the expected DM figure.

### Improving Search Discrimination

A simple check that it is indeed the candidate pulse that is responsible for the dispersion search peak around DM = 26.7 is to blank the pulse response around the candidate bin 445 and repeat the search routine.

The theoretical curve in Figure 7 and the peak tracking curve remain as Figure 5, but it is seen that blanking the candidate at bin position 445 (purple curve - fold bins 440 to 450 zeroed) completely removes the peak of the red curve response showing that the pulse around bin position 445 is indeed responsible. Subtracting the red and purple plots now produces the black curve which is identified as the DM contribution of the nulled candidate peak. This gives a much clearer indication that pulse at bin 445 peaking around DM = 26.7 confirms the dispersion measure expected for pulsar B0329.

Blanking any other peak potential candidate selected in Figure 6 produces a negligible or zero black curve difference (in this case, the pulse candidate's delayed components always dominate).

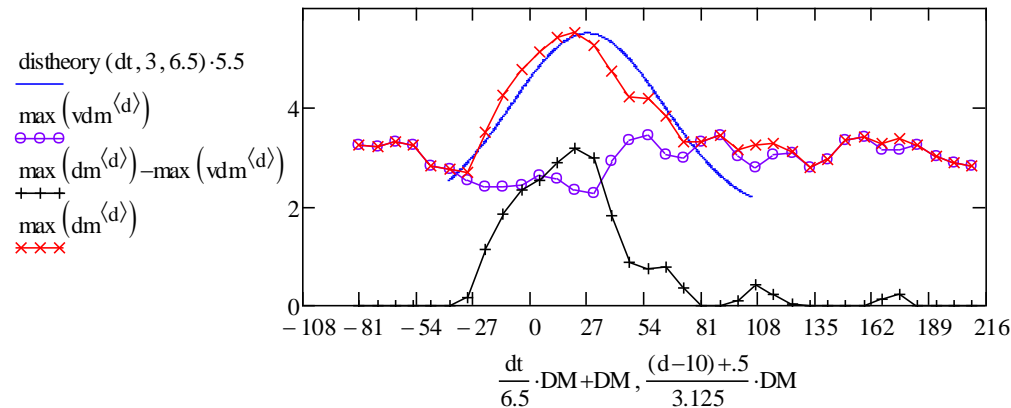

**Figure 7.** B0329 Dispersion Measure Search. blue - Gaussian Pulse Theory; red - Original Peak Data, purple - Pulse removed, black - Difference

### Data Evaluation

In a previous article it was noted that the cumulative SNR plot added insight into the scintillation nature of the pulsar and the growth of SNR in the folding integration process [5]. For the present data this is plotted in Figure 8 (red curve).

In Figure 8, the data is divided into 100 sections, each section is folded and the SNR calculated to produce the blue circle points. It is noticed that whilst appearing random due to scintillation and base noise, there is a positive mean offset. This offset mean should track the accumulated SNR of the whole data record divided by 10 (=  $\sqrt{100}$ ). The brown curve represents the accumulated section peak SNR as a function of the number of sections integrated. Finally the red curve showing a rising amplitude trend accumulates the section SNR of bin number 445, the bin

occupied by the candidate target. This shows that the candidate takes over the integrated peak by about section number 35.

There are several regions of sharp candidate rises which can be attributed to strong scintillation. There are some negative sloping regions where the target signal is weak or subsumed in background noise.

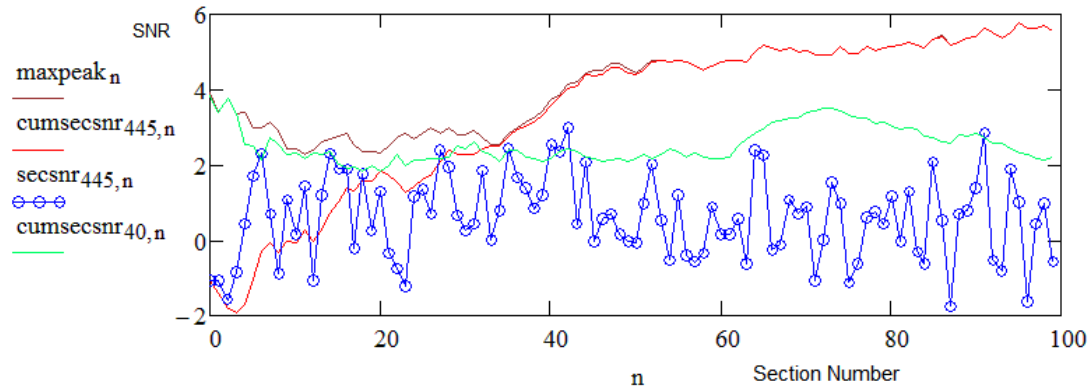

**Figure 8.** Cumulative Peak SNR (brown) , Pulsar target (red) and Section SNR (blue)

The green curve plots the cumulative SNR of the next strongest fold candidate at bin 40 (see Figure 6) and the gentle flattish rolling trend appears typical of random noise spikes. This tendency of noise peaks persisting at a modest level is also evident in the cumulative waterfall presentations (see results in Section 2 below).

### Testing the New DM Search Discriminator

The presentation in Figure 8 (blue circles, section SNR), identifies both good and bad sections contributing to the integration of the candidate pulsar. It therefore seems feasible to artificially modify some of the worst sections for indicating the candidate presence and either zero them to remove their influence and enhance the final wanted SNR or alternatively, increase them to further degrade the section and final SNR (see SNR discussion in Appendix 2). By this means, we can examine the ruggedness of the proposed DM discriminator. The pulsar candidate's eighteen lowest (negative) SNR valued fold patterns of the one hundred section SNRs were identified for modification.

These were sections: 0,1,2,3,8,12,22,23,57,63,66,71,75,76,87,92,93,96.

The test involves dividing the identified bad sections by the factor 100 to reduce their influence and improve the target SNR or multiplying the section fold amplitudes by the factor 1.8 to increase their influence and degrade the final SNR.

The result of these noise-section modification actions seen in Figure 9 are firstly, to increase the target candidate SNR from 5.5:1 (top plot) to 8.5:1 (center plot), and finally to reduce the target SNR to 3.3:1 (lower plot). It is noted in both cases that the folded base noise is largely the same and the pulse shape appears unaffected.

Other candidate noise peaks can be investigated in this way. For each candidate, large negative SNR corresponding sections are removed/reduced and searches repeated. Removal of these sections increases the relative amplitude of the candidate to the natural fold response, allowing it to be the main subject of the parameter search. It may be necessary to blank the main peak to ensure this condition.

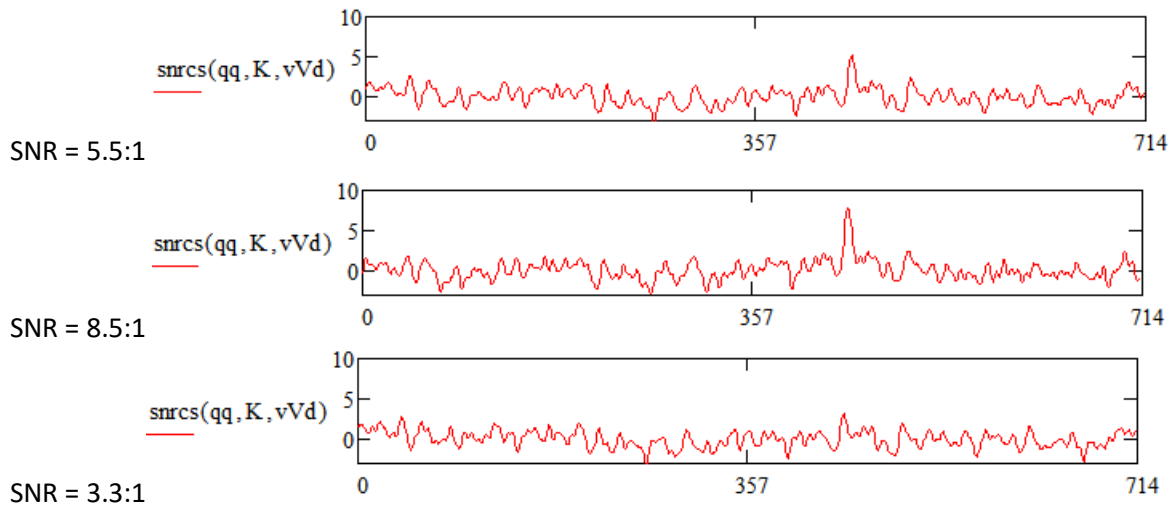

**Figure 9.** Selected Sections Reduced by the Factor 100 (8.5:1) and Increased by the factor 1.8 (3.3:1)

Figure 10 shows the DM search consequences for the two extreme SNR DM plots.

For the enhanced SNR case, the DM search peak more closely matches the Gaussian pulse theoretical solution; the peak moving closer to DM = 26.7. As a validation measure, confidence in this case can be very high. For the degraded SNR case the basic (red crosses) DM search is inconclusive, a peak around DM = 26.7 is still visible but it is not the largest peak scanned (occurring at DM = -81). What is evident with this low SNR, is that when blanking around the known target bin, an amplitude reduction over the region is now obvious and that with the suggested new discrimination method (black crosses), a clear peak still appears around the expected DM value albeit at a low amplitude figure. Blanking any other fold peak candidate produces no response around DM = 26.7.

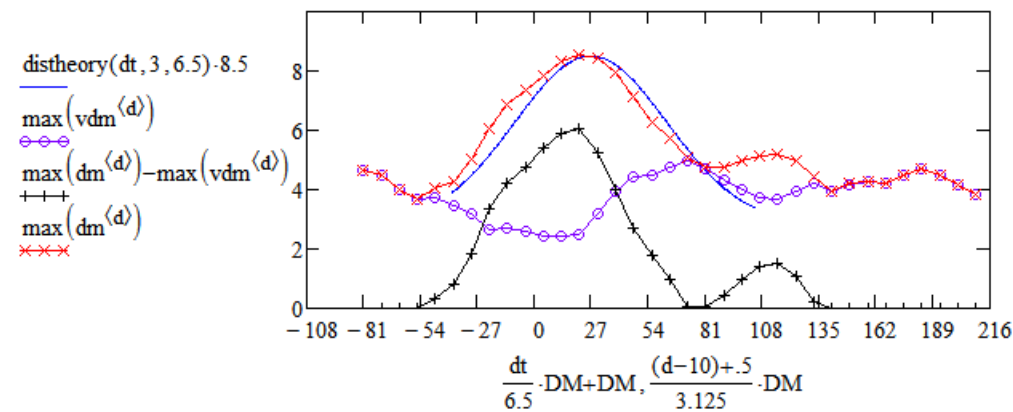

**Figure 10a.** DM Search Plot for the Case of Enhanced Data SNR = 8.5:1



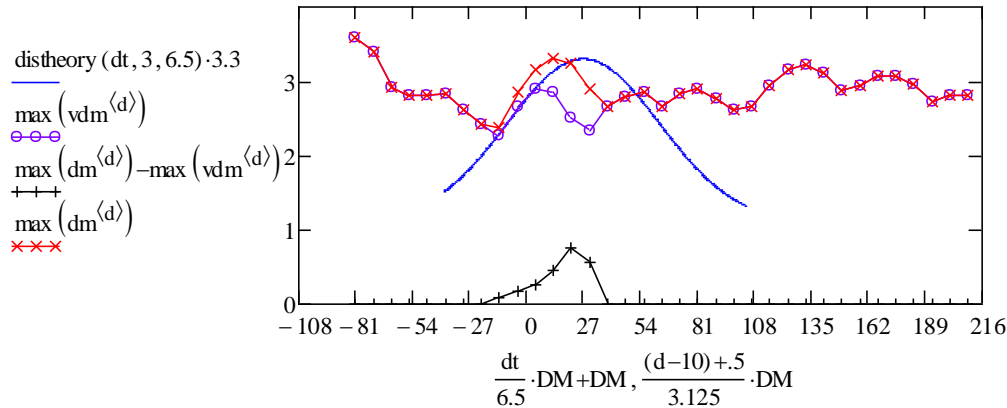

**Figure 10b.** DM Search Plots for the Case of Degraded Data SNR = 3.3:1

Section 2 contains the full PRESTO validation simulation charts for the three cases.

## Section 2. Results - PRESTO Simulation Plots

### PRESTO Sub-plot Validation - Introduction

The PRESTO *prepfold* program produces a graphical display of sub-plots from which the known pulsar characteristics can be compared for validation.

In summary, they are,

- 1a. Profile - Confirms correct topocentric period, correct pulse width, duty cycle and shape.
- 1b. Time Waterfall – Evidence of continuous, scintillating pulse train.
- 1c. Cumulative section power - Increasing trend confirms continuous scintillating pulse train.
2. Frequency Waterfall – Evidence of wide band source. (also scintillation with many bands)
- 3a. Period Search - Peak at zero confirms period matching accuracy.
- 3b. P-dot Search - peak at zero confirms high stability pulse train.
- 3c. 2D Period/P-dot plot - Central negative slope ridge confirms pulsar period and stability.
5. DM Plot - Peak around expected DM figure confirms extra-terrestrial source.

A clear indication in all sub-plots is necessary to ensure that all the expected pulsar characteristics are visibly confirmed without ambiguity before target validation is affirmed. Typically for pulsars with duty cycles around 100:1 the intercept integrated SNR for PRESTO needs to be above 10:1. This figure is reduced for lower duty cycle pulsars. Prior to running the PRESTO *prepfold* software, part of PRESTO involves running software such as *rfifind* to locate and minimize the effects of sporadic RFI and RF spurs/birdies. The PRESTO RFI mitigation processes are not clear but plots are usually optimized by repeated *prepfold* runs adjusting set software variables to optimize the final SNR.

The plots have been duplicated in this Section using MathCad representations of the PRESTO features but using peak folded SNR amplitude sensing rather than the Chi-square statistic to monitor pulsar power.

**Results 1. As Recorded Data - Integrated Apparent SNR = 5.5:1**

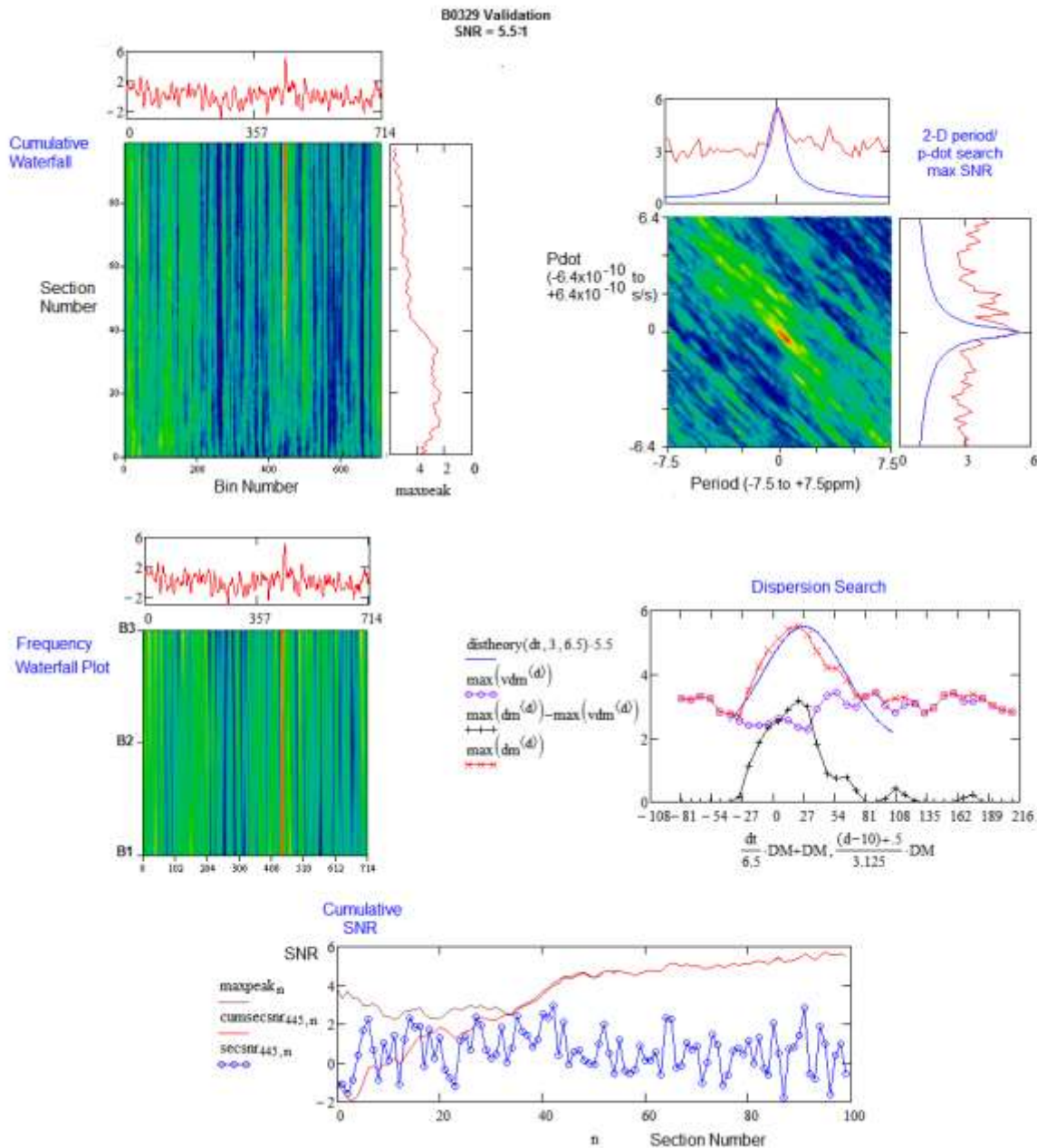

**Notes for Data 5.5:1 SNR:**

1. Cumulative Waterfall - The red line indicates that from about section 35, the integrated bin position 445 is becoming dominant resulting in the profile pattern above. The green noise streaks noted appear typical of persistent natural folded noise peaks that once established maintain a fairly flat profile. Around section 70 a typical noise peak grows in bin 40 and highlighted in Figure 8 (green plot).
2. Frequency Waterfall - Strong result in all three bands. Some noise correlation is evident, possibly due to power supply ripple.
3. 2D Period/P-dot - Peaks at the center zero for both period and p-dot. 2D display coordinates chosen so that the expected high-point ridge lies at 45 degrees for ease of visualization. Strong response observed.

4. Dispersion search - Good peak visible. New discriminator shows strong response around DM = 26.7.
5. Cumulative SNR - Steady rising integration.
6. Overall - Strong positive pulsar indications in all sub-plots.

**Results 2. Bad Data Sections Nulled - Integrated Apparent SNR = 8.5:1**

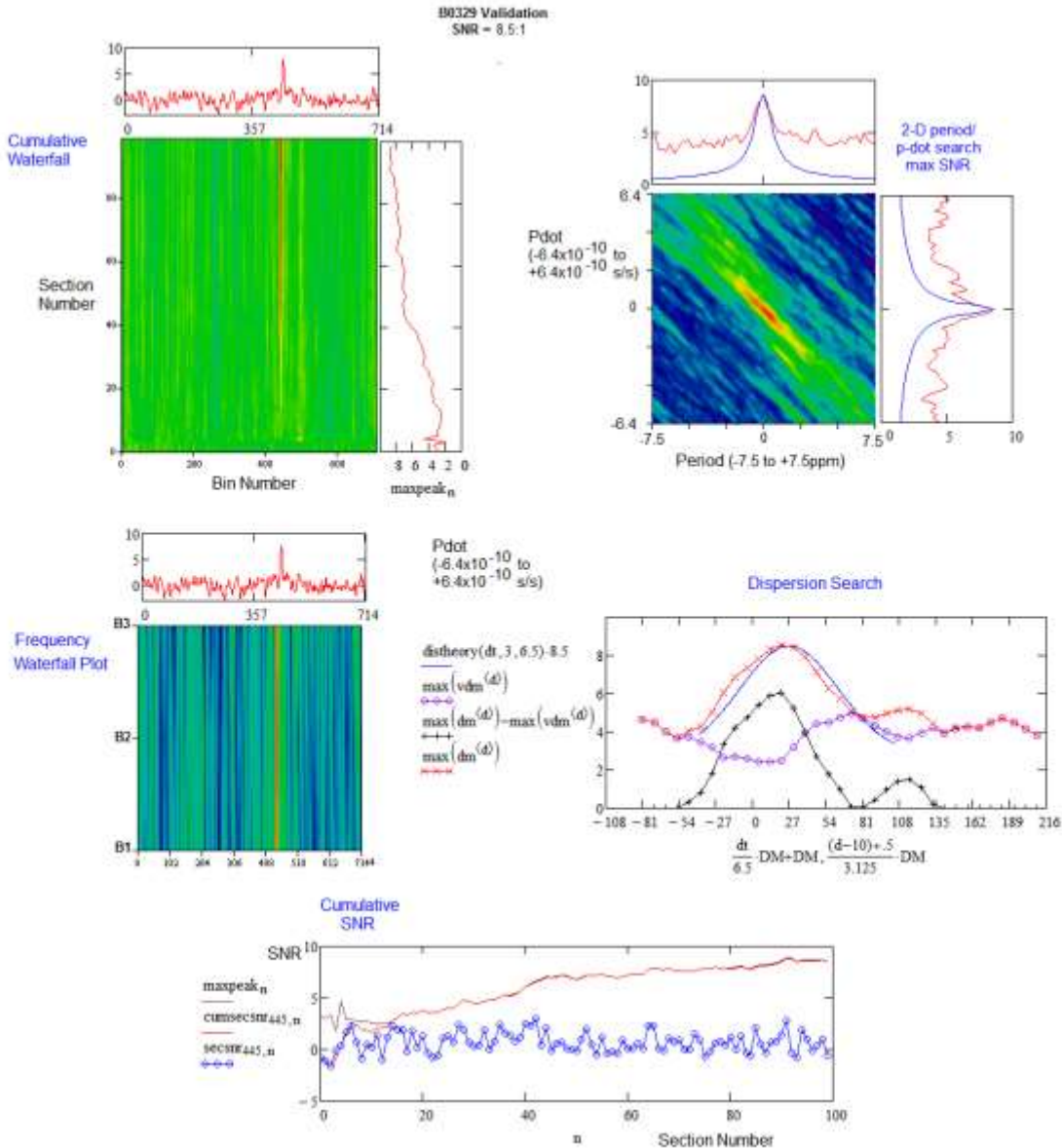

**Notes for Data 8.5:1 SNR:**

1. Cumulative Waterfall - Superior integrated SNR at bin position 445. Profile peak enhanced. The green noise streaks suppressed although some lines are persistent. Note that the base noise pattern although suppressed by the increased SNR appears still correlated over the sections.
2. Frequency Waterfall - Very strong result in all three bands. Noise/PSU ripple correlation still evident.
3. 2D Period/P-dot - Peaks at zero for both period and p-dot. 2D display coordinates set so that the more significant high-point ridge lies at 45 degrees. Very strong response.
4. Dispersion search - Strong peak more closely aligned to the theoretical curve. New discriminator shows stronger response around DM = 26.7.

5. Cumulative SNR - Steady rising integration. Largest effect seems to be due to the blanking of the first few sections - confirmed by re-analysis of the data file with the front end of the data file removed.
6. Overall - Strong positive pulsar indications in all sub-plots.

### Results 3. Bad Data Sections Further Degraded by Factor 1.8 - Integrated Apparent SNR = 3.3:1

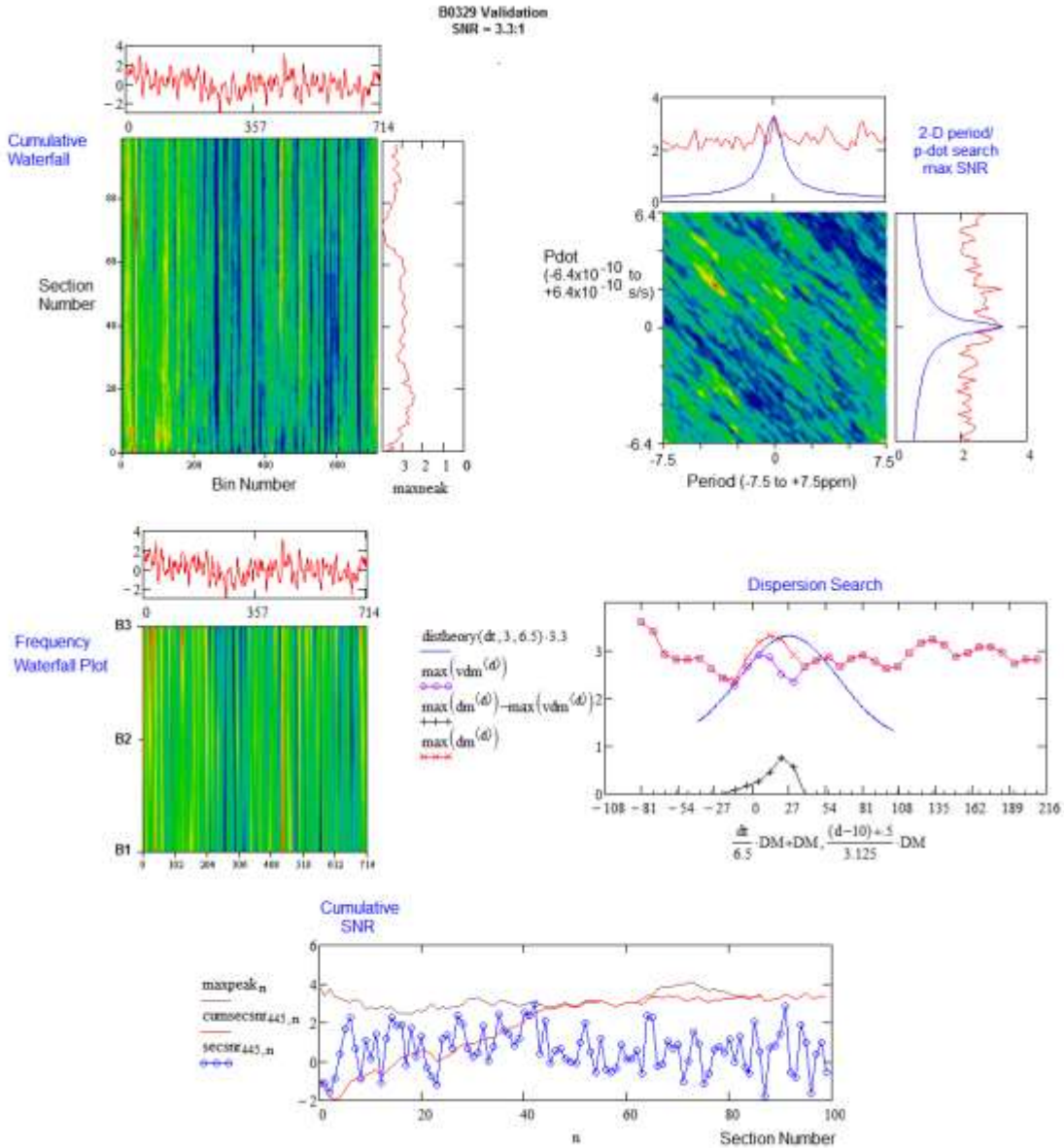

#### Notes for Data 3.3:1 SNR:

1. Cumulative Waterfall - The red line rising later around section 40 and showing evidence of some scintillation. Integration of the strongest component is still at bin position 445. Some noise streaks are competing now and the peak at bin 40 is more evident.
2. Frequency Waterfall - Good correlation of bin 445 in all bands but reduced in band 3 where other noise peaks are competing.
3. 2D Period/P-dot - Peaks at zero for both period and p-dot plots, although the background discrimination is poor. 2D display just showing evidence of a ridge (yellow) at the center (0,0) with the expected -45° slope.

4. Dispersion search - An unambiguous peak is still present although the peak is much lower than the expected value due to the influence of the base noise. The new discriminator shows a modest response but peaking closer to  $DM = 26.7$ . The new discriminator rejects the stronger noise peak of bin 40.
5. Cumulative SNR - Steady rising integration for bin 445 but indicating that the integrating noise peak of bin 40, for a short range, actually exceeds bin 445 final SNR.
6. Overall - Positive pulsar indications in all sub-plots.

**Results 4. Gaussian Noise Only - Integrated Apparent SNR = 3.25:1**

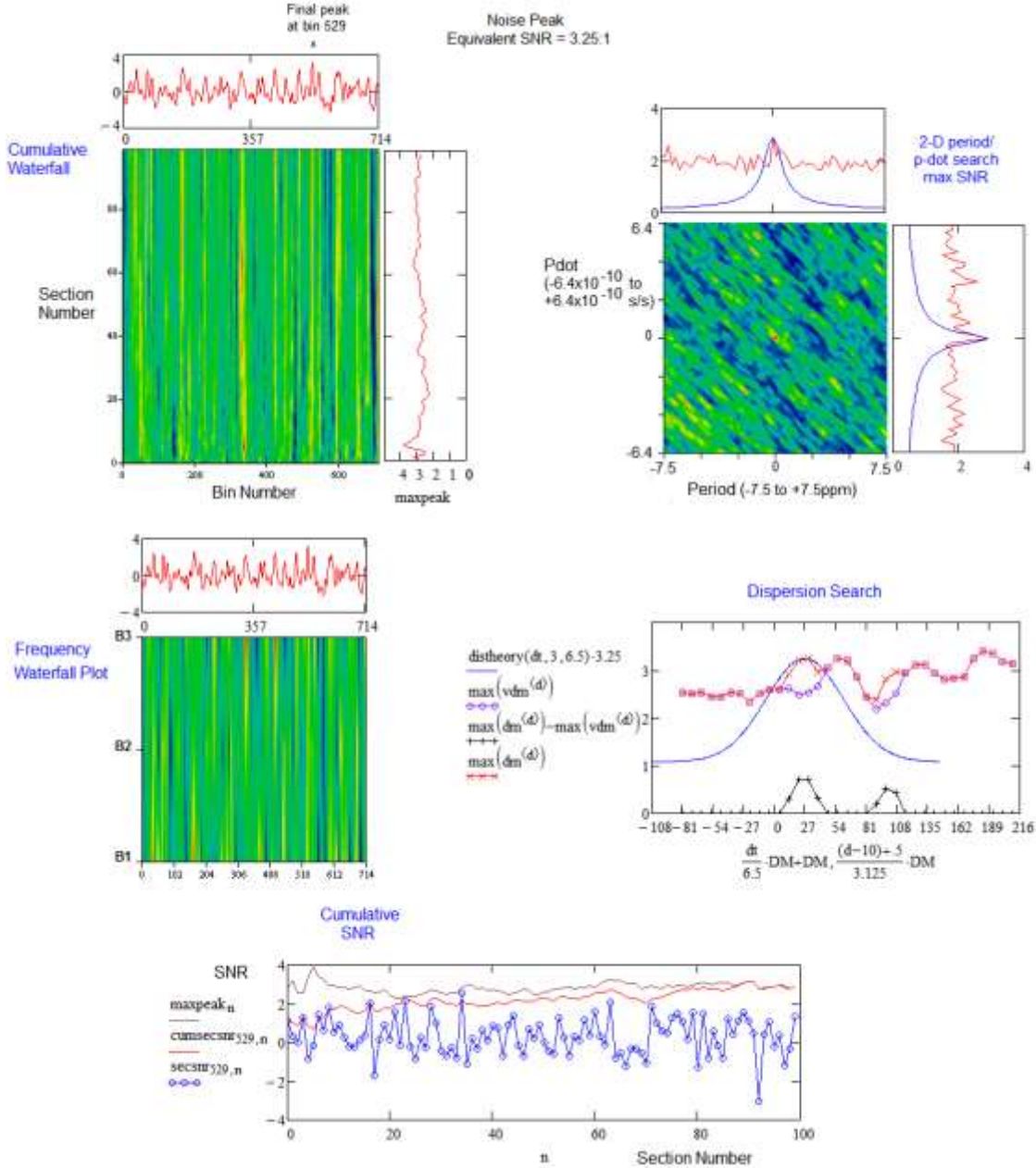

For completeness, as this is a real issue, the validation regime was tested with just Gaussian noise of the same amplitude as the data recorded.



In most trials the various sub-plots showed little evidence of a pulse-like signal. To encourage some ambiguity, after many random trials, one was selected and the search period adjusted to ensure a peak occurred in center of the 2-D period/p-dot plot and at the same time, a peak occurred at the DM expected for B0329. The resulting plot and discussion is listed below.

*Notes for Noise 3.25:1 SNR:*

1. Cumulative Waterfall - Shows the growth of bin 529 peak and rising earlier than the response of Result 3. The early generation and persistence of noise peaks seems to be an intrinsic property of the folding algorithm. Initially the accumulated noise peaks appear random but by about a fifth of the range they seem established.
2. Frequency Waterfall - A faint line (SNR  $\sim$  2:1) visible in all three bands but is overshadowed by higher peaks at other bins. Providing a noise peak is coincident in all bands, that bin will integrate linearly on summing.
3. 2D Period/P-dot - Noise data selected to ensure peaks at the center. Other peaks apparent. Little evidence of an extended  $-45^\circ$  slope ridge.
4. Dispersion search - Noise data selected to generate a peak the DM of B0329. The new discriminator shows and confirms the match too.
5. Cumulative SNR - Major difference between Results 3 and 4 is the response of the selected peak at bin 529. A fairly flat even response is typical of a noise component. Even with weak scintillating true pulsars, an upward trend is usually seen as in the Results 3 section.
6. Overall - Ambiguous pulsar-like indications in most sub-plots - further investigation is necessary.

### **Section3. Concluding Comments**

#### **Conclusions**

It has been shown that by the simple procedure of zero-blanking the extent of the pulsar candidate and repeating the full dispersion search routine on folded sub-band data, then their difference, identifies the candidates unique contribution to the dispersion measure plot with superior discrimination confidence.

Further pulsar validation confidence can be gained if the data is divided into sections and folded cumulatively. Characteristics typical of a pulsar include a rising integrated SNR trend; also, scintillation can be inferred by noting the presence of discrete positive and negative slopes.

It has also been shown that for chosen candidate peaks, bad folded sections are identified by large negative section-SNRs and if these are nulled, an increased candidate peak results which can be better tested using the standard parameter search processes. On the other hand, these bad sections can be amplified so reducing the perceived SNR to further extend full search evaluation.

PRESTO *prepfold* type graphics for the three real data SNR cases are presented in Section 2; all illustrate positive pulsar-matching characteristics in all the sub-plots.

As a caution, the three band data was replaced with uncorrelated Gaussian noise sets specially selected to pass the period, p-dot and DM search tests and the results are presented in Results 4. This exercise proved that at very low SNRs, ambiguity is always a possibility but can be mitigated with care. Increasing the number of bands will reduce the probability of noise peaks correlating constructively, as in this case and there are other subtle differences that can be exploited. Probably the most surprising observation was the persistence and near-constant level of noise peaks in the cumulative waterfall/SNR plots. RFI ambiguity was not observed in the analyzed data set, so not examined.



## Postscript

This journey through the jungle of low SNR pulsar validation has proved very rewarding and confirmed admiration for the academics that developed the PRESTO software many years ago. For amateurs, once you have proved your receiver sensitivity, the scintillating property of pulsar signal propagation means that observation success can be very variable. By correctly directing the antenna, at the right time and duration, you know it will always be there and with a forensic set of software tools, you can often find it. Some of the ideas and methods offered have proven difficult concepts for some, but all are based on the standard folding algorithm and honest use of data. Folding tens or hundreds of gigasamples of received data to a few hundred points and relying on statistics for validation, ignores much useful information on the way.

Detailed understanding of the properties of both pulsars and noise is the means to finding this flashing needle in the cosmic haystack.

## References

- [1] PRESTO Home, <https://www.cv.nrao.edu/~sransom/presto/>
- [2] SM Ransom. Searching for Pulsars with PRESTO [https://www.cv.nrao.edu/~sransom/PRESTO\\_search\\_tutorial.pdf](https://www.cv.nrao.edu/~sransom/PRESTO_search_tutorial.pdf)
- [3] PW. East, Getting the Best out of the PRESTO Pulsar Search & Analysis Tools., Journal of the Society of Amateur Radio Astronomers. January-February 2021.
- [4] PW. East, Getting the Best out of PRESTO - Part 2 The PRESTO Period/P-Dot Search Graphic., Journal of the Society of Amateur Radio Astronomers. March-April 2021.
- [5] PW East, Getting the Best out of PRESTO - Part 3: Waterfalls and Conclusions., Journal of the Society of Amateur Radio Astronomers. July-August 2021.

## Appendix 1. DM Search Sensitivity to Number of Sub-Bands

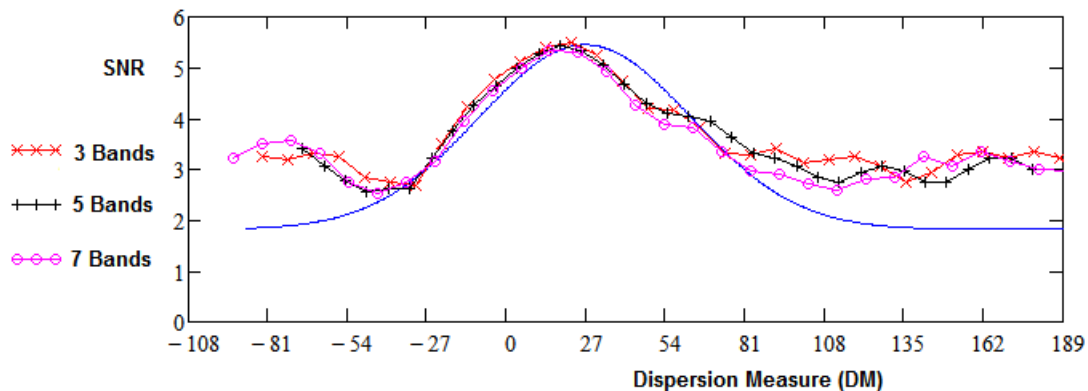

Figure A1. DM Search Plots with 3, 5 and 7 Sub-bands

Figure A1 compares the DM search sensitivity to changing the number of sub-bands and shows for the 10 MHz RF receiver band, that there is very little variation between 3, 5 and the 7 sub-band split. This confirms that in this case, reducing the number of sub-bands to three to minimize the computation load is a valid simplification.

## Appendix 2. True SNR?

The apparent SNR of the candidate pulsar in the data explored here was modified to check DM search tolerance by identifying bad sections of the data and either reducing or increasing their influence on the candidate pulsar integration process. Whilst this accomplished the aim by decreasing and increasing the base noise relative to the pulsar candidate power, so modifying the apparent SNR, it doesn't shed any light on the data true SNR. The SNR measured for any data set is the sum of the integrated candidate signal and the local bin noise (which may be

positive or negative) divided by the standard deviation of the integrated noise. The latter is usually calculated from the folded noise outside the effective pulse width. Normal folded noise peaks can typically be within the range  $\pm 2$  standard deviations, so the measured SNR can be anywhere in the range of the true SNR  $\pm 2$ . For low SNR measurements, natural selection favors finding pulsars sitting on natural folded noise peaks and this is sometimes evident from noisy search measurements of period, p-dot and dispersion. In this case, all the parameter search match discriminations improved when bad sections were removed. Noise and RFI peaks can also be enhanced with this technique for peak isolation and easing candidate search investigations.

PW East. January 2022



Peter East, *pe@y1pwe.co.uk* is retired engineer after a career of radar and electronic warfare system design. He has had a lifelong interest in radio astronomy; lately active in amateur detection and recognition of pulsars at low SNR. Novel parameter recognition algorithms that better flag pulsar features in noise have been published in the Journal to encourage members to take up the challenge. Intercepting the strongest pulsar in either hemisphere is no longer the privilege of big-aperture amateurs.

His active website is at <http://www.y1pwe.co.uk> and he is happy to answer questions.

## 1. Introduction

An experiment was performed on 27 November 2021 during the Solar Orbiter's *Earth Gravity Assist Maneuver (EGAM)*. The EGAM was necessary to place the spacecraft in its required orbit around the Sun after its launch on 10 February 2020. During the maneuver, the HAARP Ionospheric Research Instrument (IRI) transmitted a set of stepped carrier wave frequencies for spacecraft HF receiver calibration. In conjunction with the experiment, I setup two receivers in different places in Alaska to monitor and record the transmissions. I also solicited reception reports from others through the Society of Amateur Radio Astronomers (SARA) email server. This article describes the event in terms of my and three other observations. The spacecraft successfully received the HAARP IRI transmissions but a discussion of those results is beyond the scope of this article.



Solar Orbiter (left, [NASA](#)) is an international mission operated by European Space Agency (ESA) and NASA that is used to study the Sun and solar system space environment. Solar Orbiter and NASA's Parker Solar Probe work together. Solar Orbiter approached Earth within only 460 km during the EGAM. The maneuver was risky because the spacecraft had to fly through not only active satellite orbits but clouds of space junk (below, [STCE](#)). The science phase began with the EGAM. The Solar Orbiter is now on course for its close approach to the Sun in March 2022.

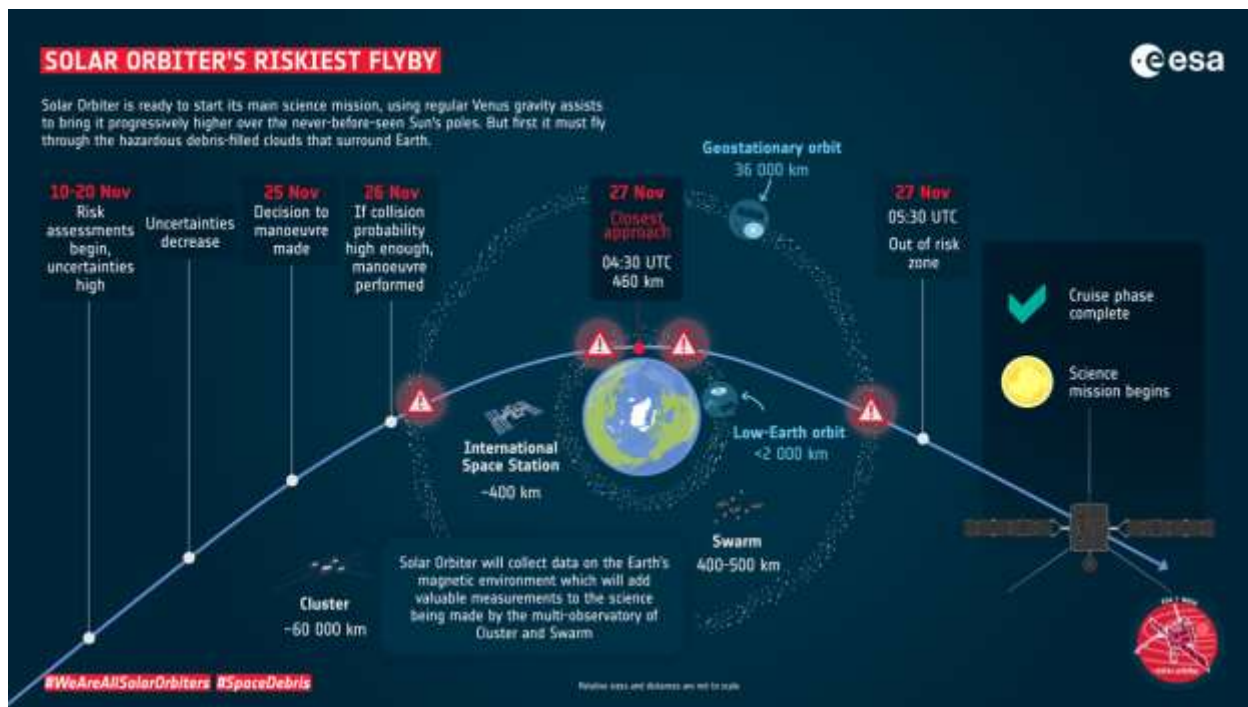

During the EGAM, Solar Orbiter entered Earth’s shadow for approximately 2 h, at which time the spacecraft’s HF receivers were calibrated without interference from solar radio noise. HAARP carrier wave transmissions were programmed to start when the spacecraft emerged from the shadow and was headed back out to space. The closest range to HAARP from the spacecraft at the start of the transmissions was 7 336 km and the farthest range at the end of the transmissions was 76 204 km.

## 2. HAARP IRI Setup

The IRI was programmed to transmit linear polarized, unmodulated carrier waves in a specific time-frequency sequence and on specific azimuths and elevations to track the satellite’s path (table 1). HAARP uses precision time and frequency supplies, synchronized by the Global Positioning System, to control the transmitters. The start time for transmissions was 0430:30 UTC, 27 November 2021 (0 min), and the elapsed time on each frequency was 9.5 min (carrier ON) with 0.5 min dwell between transmissions (carrier OFF). The total sequence was just under 2 h. For reference, the geographic coordinates of the HAARP IRI are 62° 23' 32.99" N, 145° 09' 2.26" W.

Table 1 ~ HAARP IRI transmission sequence. The IRI cannot transmit below 30° elevation, so it was set to 30° for the three low-elevation steps. Range is to the satellite from the IRI.

Reference (min): Start time (UTC)	Elapsed time (min): End time (UTC)	Frequency (MHz)	Elevation (°)	Azimuth (°)	Range (km)
0: 0430:30	9.5: 0440:00	2.775	-18 (30)	69	7 336
10: 0440:30	19.5: 0450:00	3.275	17 (30)	115	9 951
20: 0450:30	29.5: 0500:00	4.075	29 (30)	138	15 998
30: 0500:30	39.5: 0510:00	5.775	33	150	22 646
40: 0510:30	49.5: 0520:00	6.775	34	159	29 388
50: 0520:30	59.5: 0530:00	9.575	35	165	36 132
60: 0530:30	69.5: 0540:00	2.775	36	171	42 857
70: 0540:30	79.5: 0550:00	3.275	36	175	49 561
80: 0550:30	89.5: 0600:00	4.075	36	180	56 245
90: 0600:30	99.5: 0610:00	5.775	36	184	62 912
100: 0610:30	109.5: 0620:00	6.775	36	188	69 564
110: 0620:30	119.5: 0630:00	9.575	35	192	76 204

Net transmit power (forward power less reflected power) was approximately 63 dBW (2 MW) except at the band edges (near 2.8 and 10 MHz) where it was lower by about 10 dB. Antenna directivity varied from 19.0 dB at the lower frequencies to 27.6 dB at the higher frequencies, and effective isotropic radiated power (EIRP) varied from 81.8 to 90.0 dBW (151 kW to 1 MW). Examples of the antenna beam patterns show the main beams and sidelobes (figure 1). For additional information and pictures of the HAARP IRI, see [{Reeve16}](#).

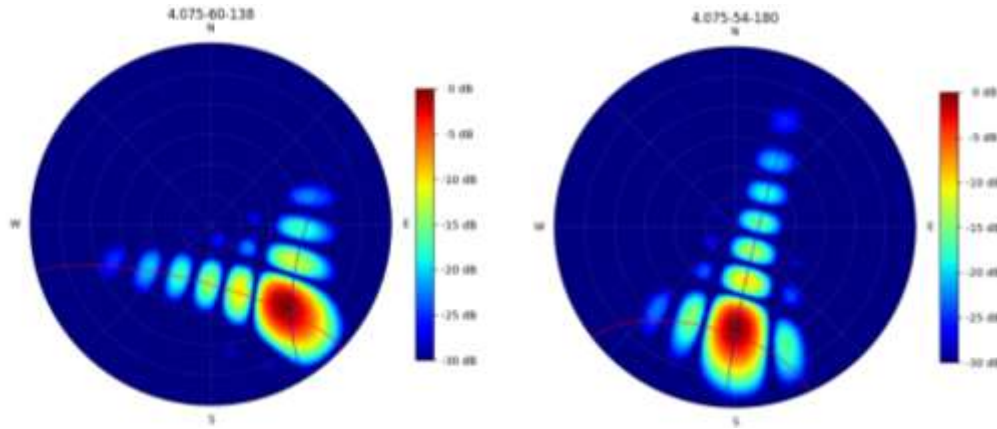

Figure 1 ~ HAARP IRI beam patterns shown in a compass format for the first (left) and second (right) 4.075 MHz transmissions. The text at the top indicates the frequency – zenith angle – azimuth. Note that elevation = 90° - zenith angle. The color graduated scale indicates relative power in the beam. From the transmitter logs for the second specific setup, forward power = 2747.3 kW, reflected power = 916.3 kW, antenna directivity = 21.64 dB and EIRP = 84.27 dBW. These details were computed for each frequency and time period.

### 3. Instrumentation at Anchorage and Cohoe

This section describes only the instrumentation used at Anchorage Radio Observatory (ARO) and Cohoe Radio Observatory (CRO), both in Alaska. The next section describes the observations at Anchorage and Cohoe and also provides information about the observations and instrumentation used by the other observers to the extent it was provided.

A rotatable 8-element log periodic dipole array with 18-32 MHz design frequency range was used at Anchorage. This antenna is usable over a much wider frequency range. It has a horizontal beamwidth in the neighborhood of 70° in the design frequency range but the beam lobe structure changes significantly outside this range. The antenna azimuth was preset to 107° with respect to true north. An omni-directional LWA Antenna was used at Cohoe. The frequency response of the LWA Antenna is best from about 20 to 100 MHz but this antenna is usable down to around 5 MHz. Its response is very poor below 5 MHz.

The block diagrams show the basic instrumentation setups at Anchorage and Cohoe (figure 2). RFSpace software defined radio (SDR) receivers, CloudSDR and Cloud-IQ, were used at Anchorage and Cohoe, respectively. The receivers were controlled by the SpectraVue software running on local PCs. The receivers were connected to each antenna through a multicoupler or splitter and supported by similar support infrastructure seen in the block diagrams.

Both SDR receivers were setup to monitor and record a relatively narrow frequency range. SpectraVue recorded the In-phase and Quadrature-phase (I/Q) digital output streams produced by the receivers in a 5.0 MHz frequency span. CRO was setup for unattended, automatic operation and was monitored from ARO.

SpectraVue is capable of only five scheduled recording setups. The center frequency is specified in the recording schedule. However, the frequency span must be preset outside of the schedule and will be the same for all recordings (unless manually changed on-the-fly). To accommodate this limitation, I programmed four recordings with a group of three time-frequency steps in each. Each recording setup included the start time for the group of

three steps, 30 min duration, and a center frequency of either 4.0 or 8.0 MHz depending on the range of the group. The 4.0 and 8.0 MHz center frequencies combined with a preset 5.0 MHz span covered the frequency ranges of 1.5 to 6.5 MHz and 5.5 to 10.5 MHz. I would have preferred separate timed recording for each time-frequency step, a total of twelve steps, and a much narrower frequency span for each step, but that was not possible with SpectraVue.

The Cloud-IQ FFT frame size is 16 384 bits for a 5.0 MHz frequency span. Its sampling rate was 61 439 970 Hz, which provided a resolution bandwidth of 374 Hz. The CloudSDR is capable of a much larger frame size and in this case it was set to 65 536 bits. Combined with the sampling rate of 61 439 870 Hz, the CloudSDR resolution bandwidth was 94 Hz.

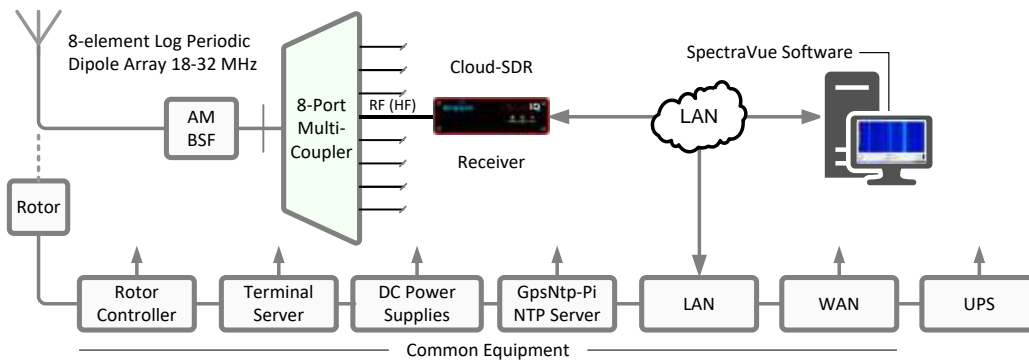

Figure 2.a ~ Anchorage Radio Observatory instrumentation block diagram; only components used in the observations are shown. The Anchorage antenna was previously pointed toward the time-frequency station WWV on 107° true azimuth and left in that position for the HAARP-Solar Orbiter experiment. The true azimuth and distance of the HAARP facility to Anchorage is 241° and 286 km.

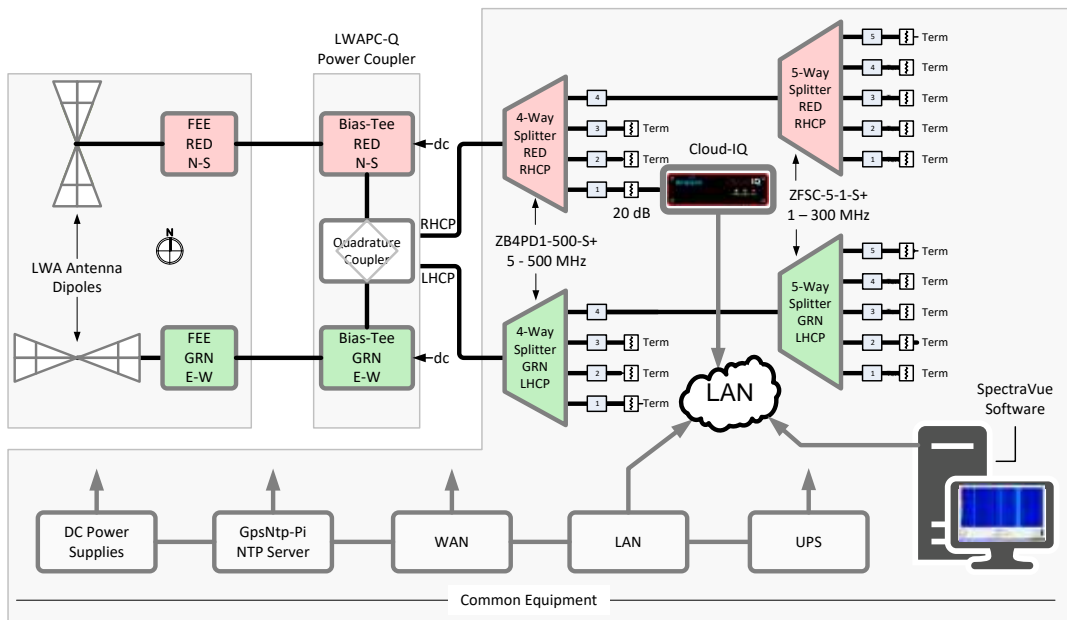

Figure 2.b ~ Cohoe Radio Observatory instrumentation block diagram; only components used in the observations are shown. The Cloud-IQ SDR receiver is connected to an RF power splitter that serves other receivers and spectrometers. The true azimuth and distance from the HAARP facility to Cohoe is 235° and 400 km.



## 4. Observations

All reception reports came from the USA and are listed in table 2 and mapped in figure 3. The solar terminator map for 0530 UTC shows the position of the Sun at midpoint of the transmissions (figure 4). The transmissions took place during the Anchorage evening hours from 7:30 pm to 9:30 pm Alaska Daylight Saving Time (DST).

Table 2 ~ Receiver station distances

Location	Distance from HAARP IRI (km)
Anchorage, Alaska	286
Cohoe, Alaska	400
Northern California	2995
Northwest Illinois	4196
Wenonah, New Jersey	5164

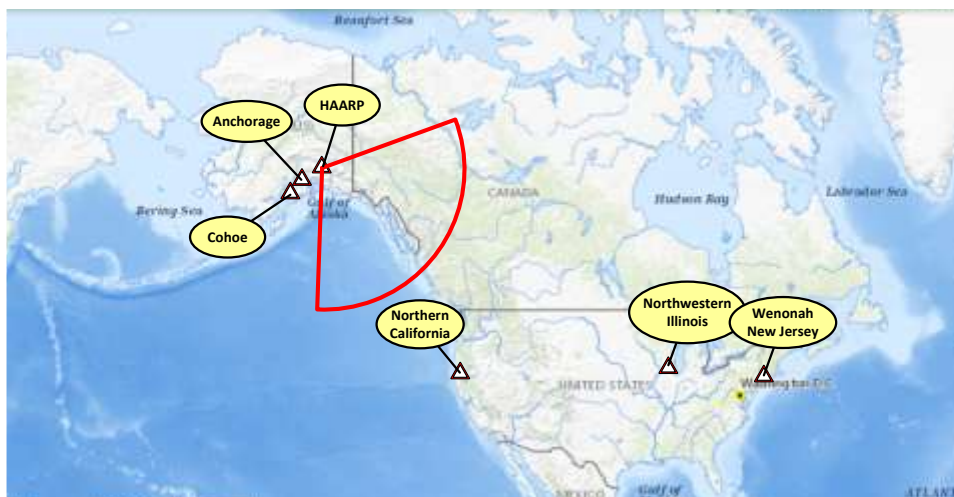

Figure 3 ~ Location map showing sites included in this report. The red arc shows the range of azimuths for the HAARP IRI transmissions. Underlying image source: USGS

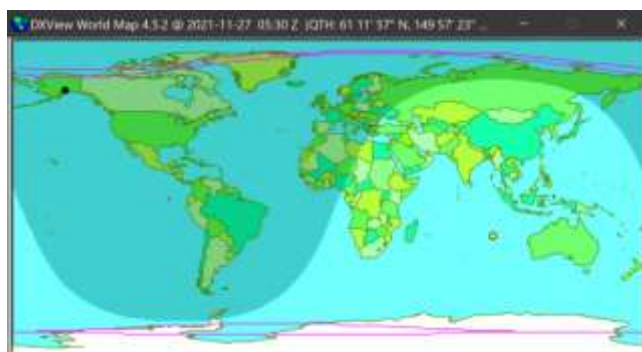

Figure 4 ~ Solar terminator map at 0530 UTC on 27 November 2021. The Sun is the small yellow circle off the Australia west coast. HAARP, ARO and CRO are in the upper-left corner.

### Southcentral Alaska:

All frequencies except those below 4 MHz were received at the Cohoe Radio Observatory, as limited by the antenna response (table 3). On the other hand, the antenna at Anchorage Radio Observatory has much better response below 4 MHz and is 100 km closer to the HAARP facility than Cohoe and all frequencies were received there.

The dynamic spectra during the transmissions show the single unmodulated carrier along with radio frequency interference (RFI) at both receiving locations (figure 5). The received signal levels at both locations varied over time due to varying propagation conditions.

Table 3 ~ Anchorage and Cohoe Reception Log  
 Times in Remarks column are time marks of field notes and are in Alaska DST.

Start time (UTC)	Frequency (MHz)	Anchorage	Cohoe	Azimuth (°)	Remarks
0430:30	2.775	Yes	No	69	7:36:27 pm
0440:30	3.275	Yes	No	115	7:42:21 pm
0450:30	4.075	Yes	Yes	138	7:52:50, 7:54:41 pm
0500:30	5.775	Yes	Yes	150	8:02:36 pm
0510:30	6.775	Yes	Yes	159	8:13:31 pm
0520:30	9.575	Yes	Higher	165	8:21:05, 8:22:05 pm
0530:30	2.775	?	?	171	No record
0540:30	3.275	?	?	175	No record
0550:30	4.075	Yes	Yes	180	8:53:45 pm, received late???, 8:58:13 pm
0600:30	5.775	Yes	Yes	184	9:01:52 pm, "both locations loud and clear"
0610:30	6.775	Yes	Yes	188	9:12:03 pm, "looking good at both locations"
0620:30	9.575	Very weak	Very weak	192	9:22:51 pm, "short burst of strong signal at Anchorage about 30 seconds after start"

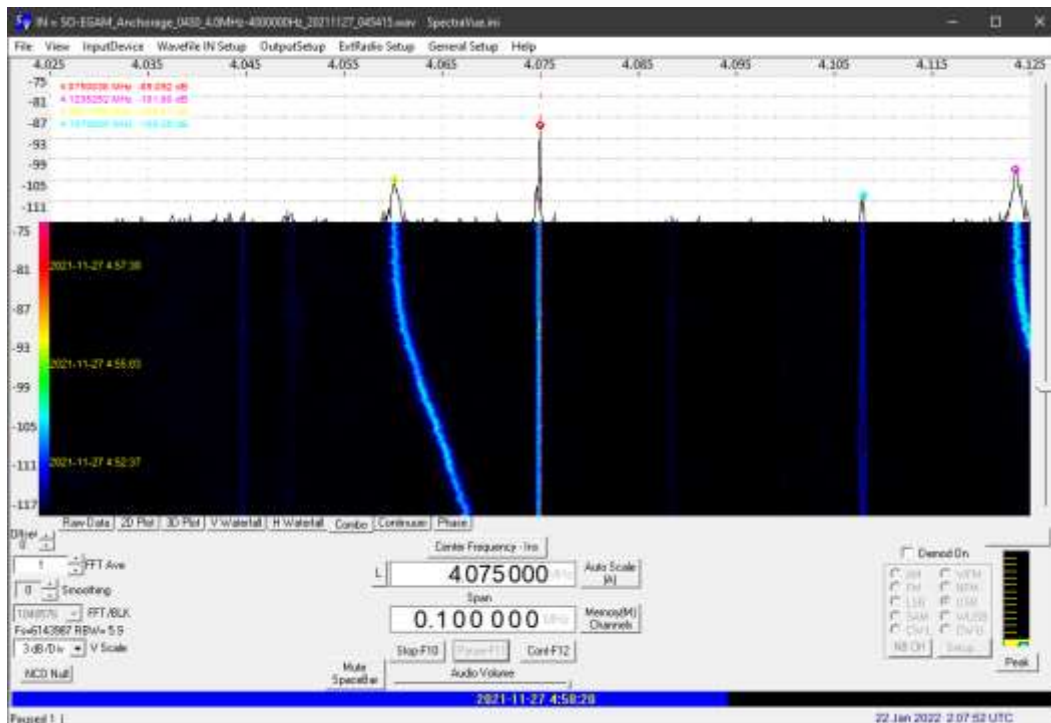

Figure 5.a ~ Spectra and vertical waterfall of the first 4.075 MHz transmission, seen here as the straight, vertical line in center, as received at Anchorage, Alaska between 0450:30 and 0500:00 UTC. The frequency span setting for this view is 100 kHz. Note the RFI drifting through the spectrum from right to left. There also appears to be some narrowband RFI very near the test frequency.

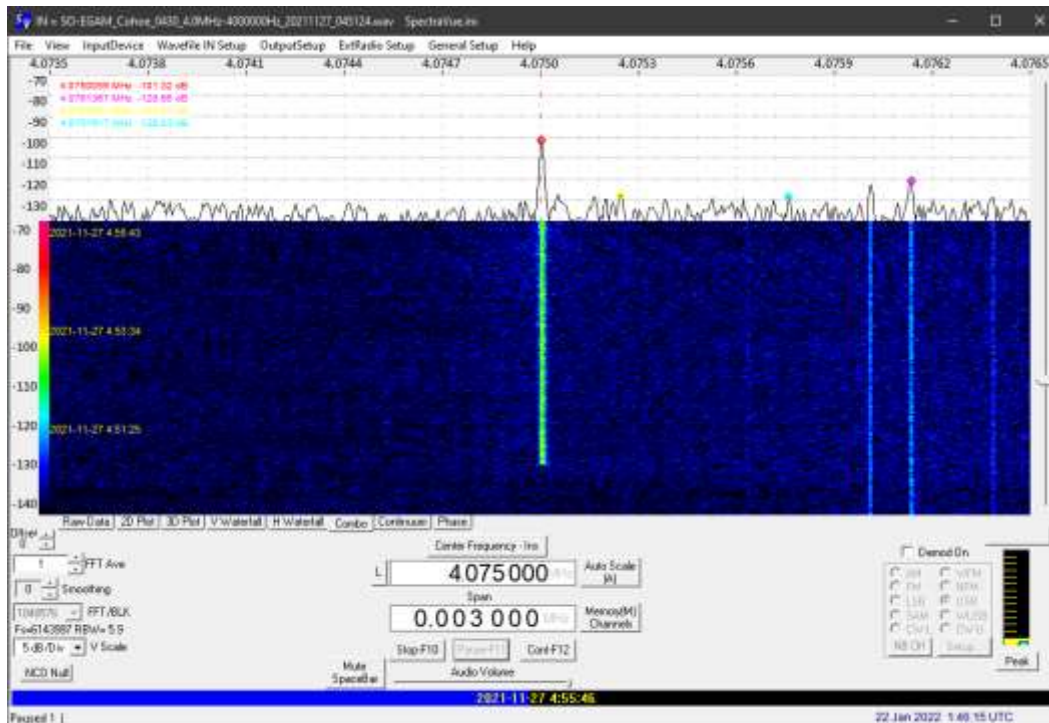

Figure 5.b ~ Spectra and vertical waterfall of the 4.075 MHz transmission received at Cohoe, Alaska starting at 0450:30 UTC, a few minutes before the previous image. The span setting for this view is 3 kHz. Cohoe also was subjected to severe RFI below around 5 MHz, and some of it can be seen between 4.0759 and 4.0765 MHz.

#### Northern California:

Doug Ronald (radio amateur call sign W6DSR), northern California USA, geographic coordinates 38.950264° N, 123.292075° W, site elevation 2331 ft ASL. The receiver was a Rohde & Schwarz ESH3 Test Receiver with radio amateur band preselection filters. The receiver was at a remote location and it was not possible to bypass the filters, so the filter closest in frequency to the transmission was used. The antenna is a log periodic dipole array (LPDA) with a gain of approximately 7 dBd and a beamwidth of 70°. It was pointed a few degrees off the path. Received signal levels are at the receiver's RF input port (table 4). In summary, all signals were strong at this site on the USA west coast in northern California.

Table 4 ~ Northern California Reception Log from Doug Ronald

Start time (UTC)	Frequency (MHz)	Received signal level at Northern California
0430:30	2.775	-75 dBm (fairly steady amplitude)
0440:30	3.275	-55 dBm (steady amplitude)
0450:30	4.075	Missed due to sumo wrestling highlights on television
0500:30	5.775	-74 dBm (with fades to -94 dBm)
0510:30	6.775	-51 dBm fades to -61 dBm
0520:30	9.575	-92 dBm (steady)
0530:30	2.775	-70 dBm (steady)
0540:30	3.275	-56 dBm (rapid fades to -110 dBm)
0550:30	4.075	-50 dBm (steady amplitude)
0600:30	5.775	-81 dBm (No signal, noise was -110 dBm in 1200 Hz bandwidth)
0610:30	6.775	-43 dBm (Wow, strongest signal of the night. No signal, noise was -100 dBm)
0620:30	9.575	-90 dBm (Some radar interference in the first few minutes which moved lower in frequency later)

Wenonah, New Jersey:

Mike Thompson (radio amateur call sign KG4JYA), Wenonah, New Jersey USA, geographic coordinates 39.7988° N, 75.1624° W, site elevation 66 ft ASL. The antenna was a long wire antenna and the receiver was part of a Yaesu FT-450 transceiver. The received signal levels are given in S-units, a convention and unit system used exclusively by radio amateur operators (table 5).

Table 5 ~ Log of received signal strength at Wenonah, New Jersey from Mike Thompson

Time (UTC)	Frequency (MHz)	Signal (see key)	Key to Signal Strength provided by observer:
04:30	2.775	S4	S1- Faint, barely perceptible;
04:40	3.275	S3	S2- Very weak; S3- Weak;
04:50	4.075	S3	S4- Fair; S5- Fairly good;
05:00	5.775	S1	S6- Good; S7- Moderately
05:10	6.775	S1	strong; S8- Strong; S9-
05:20	9.575	S1	Extremely strong.
05:30	Stopped observing		

Northwest Illinois:

Mike Otte (radio amateur call sign W9YS), northwest Illinois USA, geographic coordinates 42.21 N, 89.87 W, site elevation 800 ft AMSL. The antenna was a fan dipole for 40/80 m radio amateur wavelengths at 30 ft AGL and the receiver was part of a Yaesu FT-1000MP transceiver. The receiver audio output was connected to a PC soundcard and viewed and analyzed with SpectrumLab software. The receiver was set to USB mode and tuned 1000 Hz lower than the specified transmission frequency. The relative power levels and frequencies were determined by placing the mouse cursor near the peak of the signal on the SpectrumLab display (table 6). The highest, lowest and most frequent received signal levels were recorded. The S meter was of no use on the radio.

Table 6 ~ Log of relative audio levels recorded at northwest Illinois from Mike Otte

Frequency (MHz)	Lowest (dB)	Most frequent (dB)	Highest (dB)
2.775	-10	-6	-1
3.275	-28	-18	-10
4.075	-27	-13, -8	-4.8
5.775	-26	-16	-11
6.775	-54	-47	-43
9.575	-57	-45	-39
2.775	-28	-14, -11, -7	-1.2
3.275	-36	-24, -19	-16
4.075	-30	-22, -18	-14
5.775	-24	-18	-13
6.775	-36	-31, -25	-22
9.575	-53	-49	-49

Usually the fading was very slow, but during the second 4.075 MHz transmission period the signals faded over a few seconds. The first 6.775 MHz transmission period was inaudible but could be seen by adjusting the SpectrumLab display. During the second 6.775 MHz transmission period, the signal was well-defined but showed a *strong ghost* signal adjacent and below (maybe aurora). The second 5.775 MHz transmission period also showed a similar but narrower ghost display. There were a few *satellite-like curves* on 2.775 MHz at 05:35 that made a *full U*. I also saw a few *radar-like returns* on 5.775 MHz at 06:01:30.

## 5. Weblinks and References

- {NASA} [https://www.nasa.gov/sites/default/files/styles/image\\_card\\_4x3\\_ratio/public/thumbnails/image/solar\\_orbiter\\_artist\\_impression\\_20190916\\_1.jpg](https://www.nasa.gov/sites/default/files/styles/image_card_4x3_ratio/public/thumbnails/image/solar_orbiter_artist_impression_20190916_1.jpg)
- {Reeve16} Reeve, W., HAARP Antenna Array ~ Photographic Tour 2016:  
[https://www.reeve.com/Documents/Articles%20Papers/Reeve\\_HAARP16.pdf](https://www.reeve.com/Documents/Articles%20Papers/Reeve_HAARP16.pdf)
- {STCE} <http://www.stce.be/newsletter/pdf/2021/STCEnews20211126.pdf>

## 6. Acknowledgements

The author is grateful to Doug Ronald, Mike Thompson and Mike Otte for their reception reports and permission to use them in this article and to the HAARP operating personnel for providing the transmission data.

# Low Frequency Observations of the 4 December 2021 Solar Eclipse

Whitham D. Reeve

---

## 1. Introduction

A total solar eclipse took place at high latitude in the southern hemisphere on 4 December 2021. The eclipse shadow passed over Union Glacier on Antarctica and the adjacent Weddell Sea. An attempt was made to observe the eclipse at low frequencies from a location over 16 thousand km away in the northern hemisphere at Cohoe Radio Observatory (CRO) in southcentral Alaska (figure 1).



Figure 1 ~ Map showing location of Cohoe Radio Observatory in the northern hemisphere with respect to the point of greatest eclipse in the southern hemisphere on 4 December 2021. Underlying image source: GIS StackExchange

Although it is known that solar eclipses can affect low frequency radio propagation, it was not known what effects, if any, this eclipse would have on propagation paths widely separated from the eclipse path. To try to find out, I recorded and analyzed the received signals from three radio transmitters in the *very low frequency* (VLF, 3 to 30 kHz) and *low frequency* (LF, 30 to 300 kHz) bands. The recordings covered time periods before, during and after the 4 December eclipse.

I did not expect to observe perturbed propagation because of the distances involved, and the results described in section 4 are inconclusive. However, I was interested in determining and learning about reliable sources of relevant eclipse data and the analytic procedures and radio observation techniques that might be specific to eclipses. This article briefly discusses low frequency radio propagation (section 2), eclipse characteristics (section 3), results of the observations (section 4), discussion of the results (section 5) and the instrumentation and setups (section 6). This information sets the stage for observations of future eclipses.

---

## 2. Brief Overview of Low Frequency Propagation & Propagation Path Characteristics

The low frequency signals of interest here propagate in the spherical Earth-ionosphere waveguide in which the ionosphere forms the upper boundary and Earth's surface forms the lower boundary of the waveguide. Under normal diurnal conditions, the ionosphere's D-region changes height in response to solar radiation. During the day, the D-region is lower and radio waves with frequencies in the tens of kilohertz range encounter more absorption leading to lower received signal levels. At night, the D-region rises (or disappears) and the radio waves



encounter less absorption leading to higher received signal levels. For a more detailed discussion on VLF propagation, see [Reeve19-1](#)

During normal conditions, daily plots of the signal power received from a given distant low frequency transmitter show a characteristic pattern. However, the D-region electron density in the shadow of a solar eclipse decreases, thus temporarily affecting radio waves passing through it and disturbing the characteristic pattern. Thus, observing an eclipse at low frequencies may show variations in the duration and timing due to perturbances along the propagation paths.

Low frequency signals can follow a direct great circle path from the transmitter to receiver, called *short path*. Because low frequency signal attenuation in the Earth-ionosphere waveguide is so low, the signals also may propagate on a longer great circle path in the opposite direction, called *long path*. Other paths are possible because of the spherical nature of the waveguide and land, water and ice interfaces along the way. Because of the many possible propagation modes, a given location can experience destructive or constructive interference that varies over time and with propagation conditions.

The great circle propagation paths to CRO from only four transmitter stations, out of 12 to 15 that are receivable at CRO, intersected or nearly intersected the eclipse path (table 1). Three of the four transmitter stations, JJI, NLK and WWVB, are located in the northern hemisphere. All propagation path intersections, or near intersections, occurred only on the long paths and early in the eclipse event.

Table 1 ~ Transmitter stations and path characteristics. All distances and azimuths are with respect to Cohoe Radio Observatory (CRO). The long path distances are determined by first calculating the short path distances and subtracting the result from 40 000 km, Earth’s approximate circumference. Station key: NWC: North West Cape, Australia; JJI: Ebino, Miyazaki, Japan; NLK: Washington, USA; WWVB: Colorado, USA (a receiver was not setup for WWVB on this eclipse).

Station	Frequency (kHz)	Short Path distance (km)	Short path azimuth (° TN)	Long path distance (km)	Geographical Coordinates	Remarks
NWC	19.8	12 350	263	27 650	21.816° S, 114.166° E	
JJI	22.2	6 299	277	33 701	32.076° N, 130.829° E	
NLK	24.8	2 308	113	37 792	48.203° N, 121.917° W	
WWVB	60.0	3 818	104	36 182	40.678° N, 105.047° W	Rx not setup
CRO	RX	NA	NA	NA	60.368° N, 151.315° W	For reference

For the eclipse on 4 December 2021, CRO was on Earth’s nightside with partial illumination of the short and long paths during the eclipse time period. Mercator projection plots show the solar terminator and propagation paths for the time of greatest eclipse (0735 UTC) (figure 2). The solar terminator moves east-to-west as the Sun moves across the sky. Note that the long paths and early edges of the eclipse shadow are close to the solar terminator.

Earth’s magnetic field influences radio propagation, so I considered both the magnetic coordinates of the point of greatest eclipse and the conjugate of those coordinates. The geographic coordinates of the greatest eclipse location were 76° 46.7’ S, 46° 11.9’ W. The conjugate point is determined by first calculating the geomagnetic coordinates of the greatest eclipse geographic location, taking the conjugate of the geomagnetic coordinates and then converting the conjugate to geographic coordinates for plotting purposes.

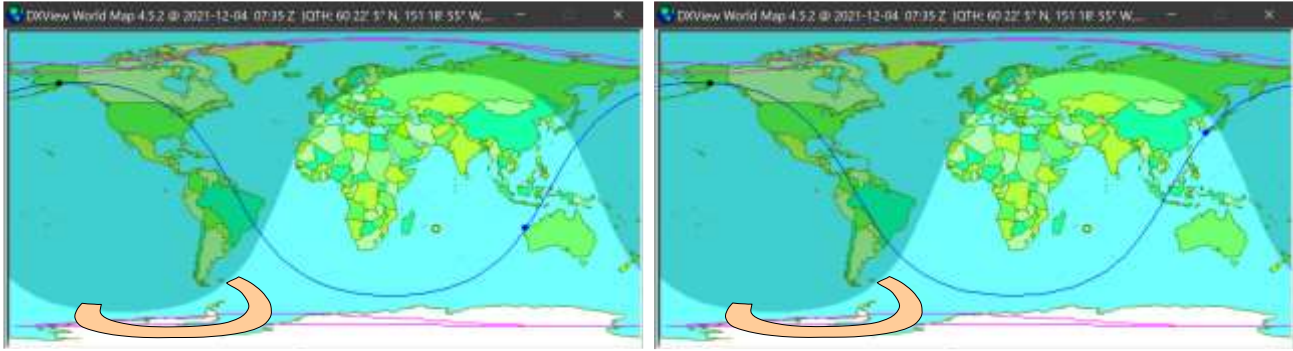

Figure 2.a ~ Solar terminator near time of greatest eclipse and short and long paths for transmitter stations NWC in Australia, 19.8 kHz (left) and JJI in Japan, 22.2 kHz (right). The path of total eclipse is shown in the lower-left corner as a tan arc. Areas of partial eclipse cover a much larger area, primarily over Antarctica. Underlying plots from [DXView](#) software

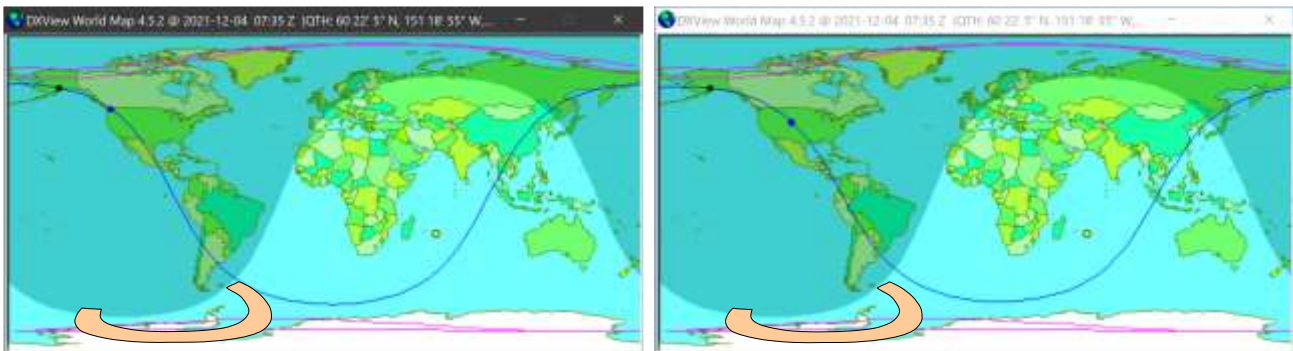

Figure 2.b ~ Solar terminator near time of greatest eclipse and short and long paths for transmitter stations NLK in Washington USA, 24.8 kHz (left) and WWVB in Colorado USA, 60 kHz (right). The path of total eclipse is shown in the lower-left corner as a tan arc. The long path from station NLK comes closest to the total eclipse path. Areas of partial eclipse cover a much larger area, primarily over Antarctica. Underlying plots from [DXView](#) software

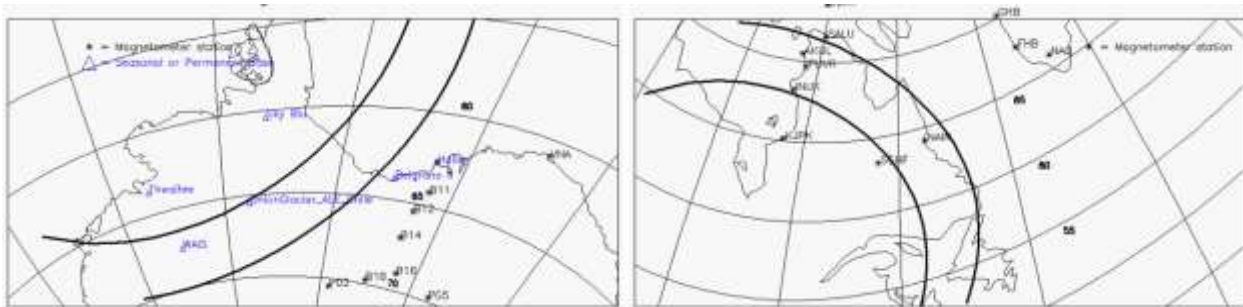

Figure 3 ~ Sketches of the actual eclipse path over Antarctica (left) and the magnetic conjugate path over northeastern Canada (right). Source: Unknown

The geomagnetic coordinates calculated from [Kyoto](#) of the greatest eclipse location are  $67.88^\circ$  S,  $15.81^\circ$  E, and the conjugate coordinates are  $67.88^\circ$  N,  $15.81^\circ$  E. Conversion of the conjugate geomagnetic coordinates to geographic coordinates, again from [Kyoto](#), gives  $58^\circ 53.76'$  N,  $61^\circ 16.92'$  W. This is located near the coast of Newfoundland and Labrador and the Labrador Sea. These coordinates are for a single point; the conjugate path follows an arc across northwestern Canada. Sketches show the eclipse paths at both locations (figure 3).

Comparison to the solar terminator plots shows that none of the radio propagation paths were near the conjugate path.

---

### 3. Eclipse Characteristics

The greatest eclipse was reached at approximately 0735 UTC (10:35 pm Alaska Standard Time). The Sun was fully eclipsed for about 1 h (0700 to 0806) and partially eclipsed for about 4 h (0529 to 0937 UTC).

The Sun and eclipse path characteristics are summarized by NASA's Goddard Space Flight Center (figure 4). An animation of the eclipse may be seen at [{NASA-AN}](#). Additional eclipse information and graphics are available at [{TD4Dec}](#) including a color-graduated image of the partial and total eclipse regions (figure 5).

---

### 4. Observations

The received signals from stations NWC (19.8 kHz), JJI (22.2 kHz) and NLK (24.8 kHz) were sampled and recorded at 15 s intervals for 3 d before, day of and 3 d after the eclipse (instrumentation is described in section 6). The extended time period was implemented to establish daily signal patterns unaffected by the eclipse that could be compared to the day of the eclipse. Signal data plots are shown for each of the three stations for the 7-day period (figure 6) as well as a combined plot of the three stations on the day of the eclipse (figure 7). Shaded areas on the plots indicate local darkness (sunset to sunrise) at CRO.

Regular signal level variations are observed due to sunrise and sunset along the propagation paths. The times and specific details of these variations depend on, among other things, the location of the transmitter and receiver stations with respect to the moving solar terminator.

The plots include a solid gold vertical arrow that marks the time of the greatest eclipse (0735 UTC), and dashed gold arrows that show the same time of day as the eclipse but on the days before and after the eclipse. The dashed arrows are used to establish a reference signal time pattern for comparison to the eclipse time.

Sunset at Cohoe on 3 December was 0104 UTC (4:04 pm local time on 3 December), about 6.5 h before the eclipse. The following sunrise was 1849 UTC (9:49 am local time on 4 December), approximately 11 h after the eclipse. Therefore, the local Cohoe sunrise and sunset were outside the time of the eclipse event. Cohoe is at geographic latitude 60° N and the daylight hours are short during December, lasting only 6.25 h on eclipse day. Referring to the solar terminator plots above, the short and long radio propagation paths cross the solar terminator in various ways (table 2).

## Total Solar Eclipse of 2021 Dec 04

Geocentric Conjunction = 07:56:04.9 UT    J.D. = 2459552.830612  
 Greatest Eclipse = 07:33:22.5 UT    J.D. = 2459552.814844

Eclipse Magnitude = 1.0367    Gamma = -0.9526

Saros Series = 152    Member = 13 of 70

Sun at Greatest Eclipse  
 (Geocentric Coordinates)

R.A. = 16h43m32.3s  
 Dec. = -22°16'29.3"  
 S.D. = 00°16'13.6"  
 H.P. = 00°00'08.9"

Moon at Greatest Eclipse  
 (Geocentric Coordinates)

R.A. = 16h42m34.9s  
 Dec. = -23°13'22.1"  
 S.D. = 00°16'44.7"  
 H.P. = 01°01'27.3"

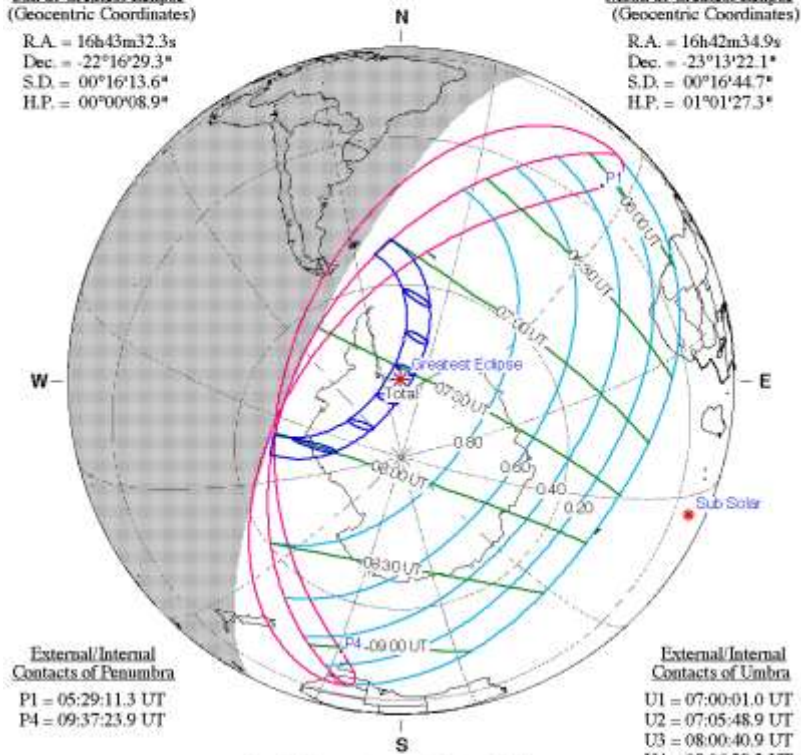

External/Internal  
 Contacts of Penumbra  
 P1 = 05:29:11.3 UT  
 P4 = 09:37:23.9 UT

External/Internal  
 Contacts of Umbra  
 U1 = 07:00:01.0 UT  
 U2 = 07:05:48.9 UT  
 U3 = 08:00:40.9 UT  
 U4 = 08:06:29.2 UT

Local Circumstances at Greatest Eclipse

Lat. = 76°46.7'S    Sun Alt. = 17.2°  
 Long. = 046°11.9'W    Sun Azm. = 114.8°  
 Path Width = 418.6 km    Duration = 01m54.4s

Ephemeris & Constants

Eph. = Newcomb/ILE  
 $\Delta T = 78.8$  s  
 $k1 = 0.2724880$   
 $k2 = 0.2722810$   
 $\Delta b = 0.0''$      $\Delta l = 0.0''$

Geocentric Libration  
 (Optical + Physical)

$l = -0.23^\circ$   
 $b = 1.26^\circ$   
 $c = 6.09^\circ$

Brown Lun. No. = 1224

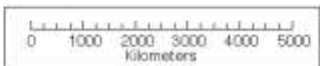

F. Espenak, NASA's GSFC · Fri, Jul 2,  
[sunearth.gsfc.nasa.gov/eclipse/eclipse.html](http://sunearth.gsfc.nasa.gov/eclipse/eclipse.html)

Figure 4 ~ Detailed characteristics of the 4 December eclipse. The asterisk at the center of the map marks the point on Earth's surface nearest to the axis of the Moon's shadow at greatest eclipse. The blue arcs indicate the extent of the greatest eclipse with oblong marks at 10-minute intervals. The looped magenta lines show the extent of the Moon's shadow nearest to the sunrise/sunset line (solar terminator). The cyan lines indicate the path of the Moon's shadow with green time marks at 30-minute intervals. The times of first and last contacts of the partial eclipse shadow (penumbra) are indicated by P1 and P2 and the times of the contacts of the total eclipse (umbra) are indicated by U1 through U4. The definitions of other details in this image can be found at [{NASAKey}](#). Image source: NASA GFSC [{NASA4Dec}](#)

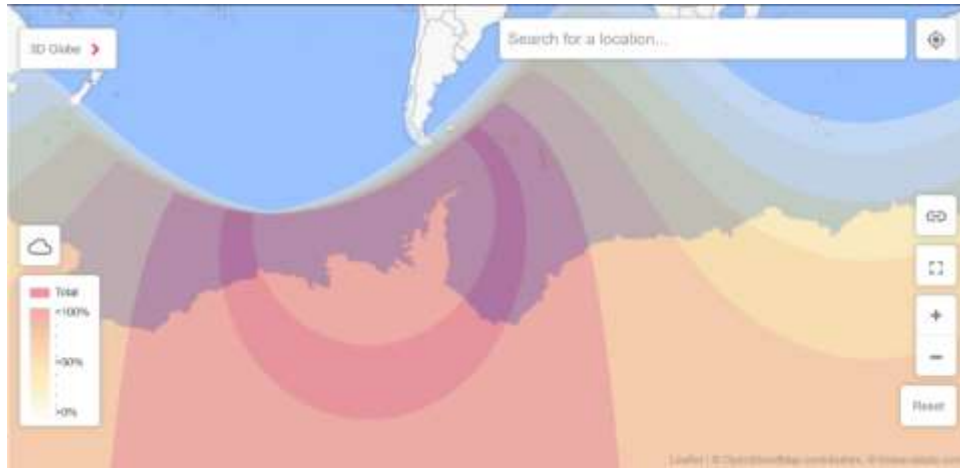

Figure 5 ~ Map showing the extent of total and partial eclipse areas, indicated on the color scale in the lower-left corner. Comparison with the solar terminator maps above indicates that the propagation long paths of the three stations NWC, JJI and NLK cross areas of partial eclipse. Image source {[TD4Dec](#)}.

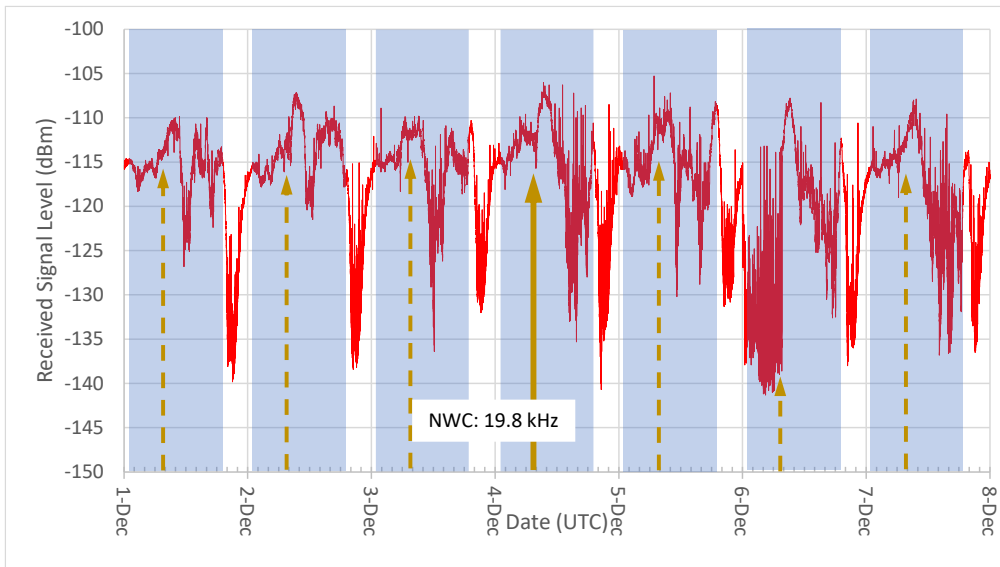

Figure 6.a ~ NWC (19.8 kHz). The daily patterns show approximately 25 dB signal level decrease for a few hours during the local Cohoe morning. The station apparently was off-the-air for several hours on 6 December. A minor signal level dip before peak occurs between around 0100 and 0800 each day, possibly due to sunrise or sunset along the paths.

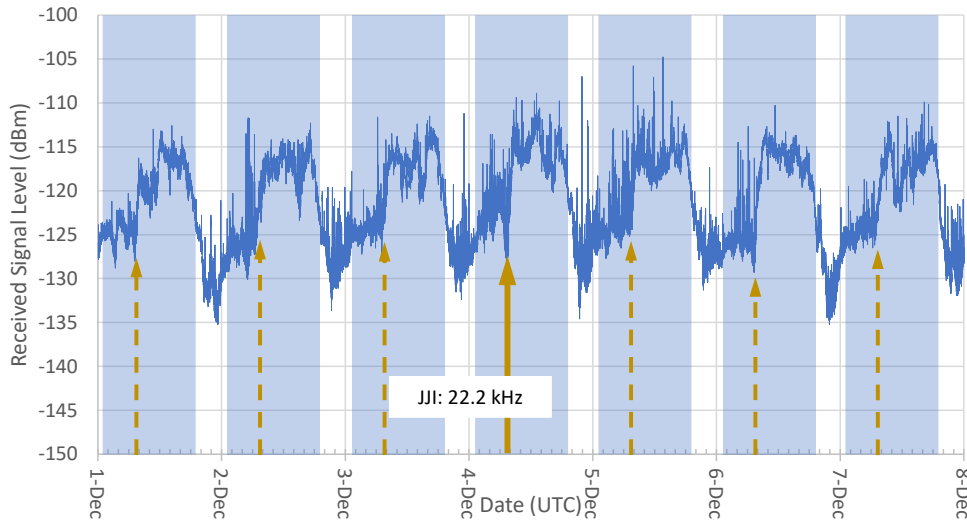

Figure 6.b ~ Station JJI (22.2 kHz). The daily patterns are similar to NWC except that the daytime signal level dip is approximately 20 dB and the only dip occurs on eclipse day; all other days show a relatively sharp increase in received signal level.

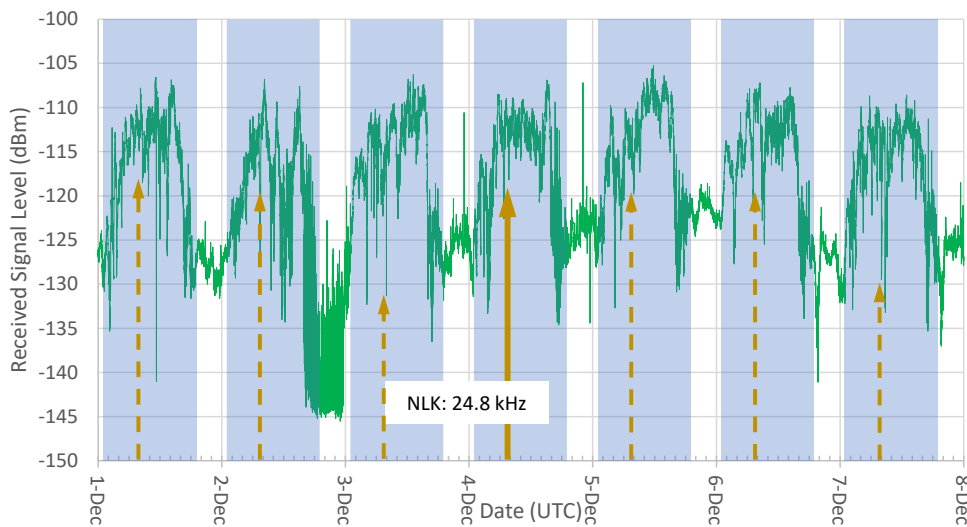

Figure 6.c ~ Station NLK (24.8 kHz). The daytime (Cohoe) signal levels decrease about 15 dB with no obvious change in signal patterns on eclipse day. An apparent outage occurred late in the UTC day 2 December.



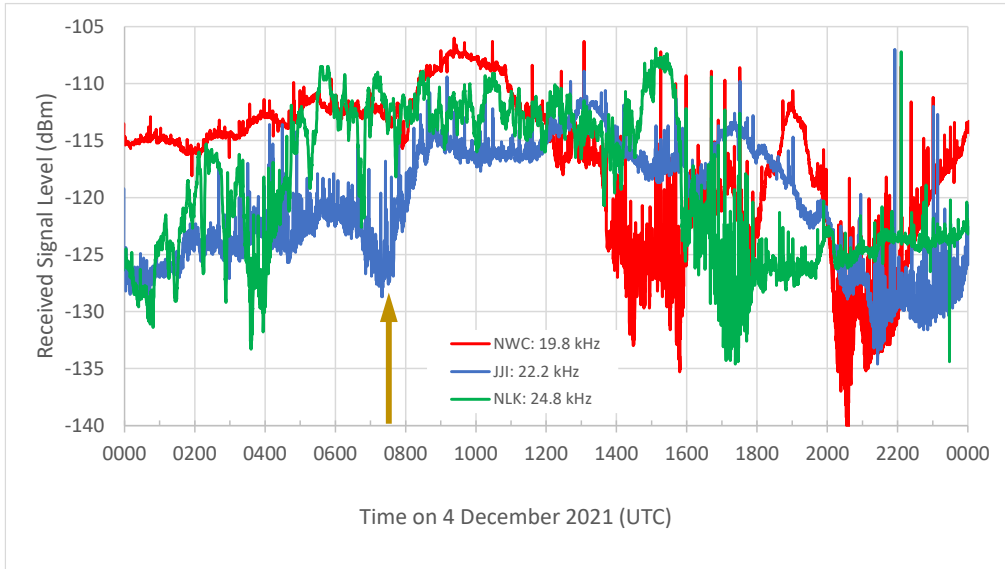

Figure 7 ~ Combine plot of all three stations on eclipse day. Stations NWC (red trace) and JJI (blue trace) show an anomaly at the time of greatest eclipse, lasting roughly 1 h and indicated by the gold arrow. The minimum of the dip of the NWC signal occurs about 30 min later than JJI.

Table 2 ~ Solar terminator crossings of short and long propagation paths

Station (Frequency)	Short Path Crossing	Long Path Crossing
NWC (19.8 kHz)	Yes, once	Yes, once
JJI (22.2 kHz)	Yes, once	Yes, once
NLK (24.8 kHz)	No	Yes, twice

The received signal plots broadly show the expected daily signal variations – signal increase at night and signal decrease during the day with various dips and peaks, and ramp-ups and ramp-downs depending on the path and time of day. Stations NWC (19.8 kHz) and JJI (22.2 kHz) show a relatively slow signal ramp-up for a few hours after local sunset followed by a much quicker ramp-up near the middle of the local night. The received signal levels then dip before rising again. A deep dip occurs near local sunrise. The short path propagation direction from these two stations is west-to-east. Station NLK (24.8 kHz) with east-to-west propagation shows a somewhat different pattern but the local daytime signal reduction still is obvious.

## 5. Discussion

It is reasonable to assume that eclipse effects could be observed not only during the time period of total eclipse but also during the partial eclipse periods – any time the radio path passes through or near the eclipse shadow – so the main period of interest runs at least from 0529 to 0937 UTC.

The two eastern transmitters, NWC in Australia and JJI in Japan, show a distinct dip in the received signal level during the time period of total eclipse. The signal from station JJI starts to decrease at about 0600 and has fully recovered by 0800. The dip in the signal from NWC is not as pronounced and occurs at 0800, approximately 30 min after JJI. For comparison, in the brief analysis of the annular solar eclipse over northeastern Canada on 10 June 2021 ([Reeve21](#)), anomalous signal levels at eclipse time compared to the days surrounding the eclipse were noted on the radio path from station NPM (21.4 kHz) in Hawaii to CRO.

Concluding that these eclipses clearly affected the received signals requires too much imagination and no such conclusion is made here. It remains to be seen if studies of future eclipses reveal a similar pattern.

On the other hand, the effort was successful in terms of procedure development and data reduction and these methods will be used during the future eclipses listed in table 3. It should be no surprise that one of the most important and useful information sources is NASA at [{NASA-SE}](#). I also found the graphics on [{TimeDate}](#) very useful and in some ways easier to use than the much broader range of technical data available from NASA. Section 7 lists these references as well as the specific webpages used for the 4 December eclipse and other useful websites.

Table 3 ~ Solar eclipses 2022 through 2024 (source: [{NASA-DEC}](#))

Date	Type	Hemisphere	Remarks
30 April 2022	Partial	Southern	Same general area as 4 Dec 2021 eclipse
25 October 2022	Partial	Northern	
20 April 2023	Hybrid	Primarily southern	Crosses equator near end
14 October 2023	Annular	Primarily northern	Crosses equator near end
8 April 2024	Total	Primarily northern	Crosses equator near beginning
2 October 2024	Annular	Primarily southern	Crosses equator near beginning

Radio observation techniques and procedures are described in section 6. Most of these were developed over several years of observations with software defined radio (SDR) receivers and both a shop-built and a refurbished commercial loop antenna at Coho Radio Observatory.

Although the time-frequency station WWVB (60 kHz) in Colorado was mentioned in section 2, the square loop antenna used for the observations is not usable at 60 kHz and a receiver was not setup for that station. However, a dedicated loop antenna designed for 60 kHz and an SDR receiver will be setup for future eclipses. The additional data will be integrated and analyzed in the same manner as described here.

## 6. Instrumentation

The major components at Coho Radio Observatory used in the above-described observations were a shop-built square loop antenna, an SDRPlay *RSPduo* SDR receiver and a Lenovo small form factor PC running Windows 10. The square loop is an untuned passive antenna preset to an east-west azimuth. *SDRuno* software, which is native to the SDRPlay SDR products, was used to gather received signal level data. A block diagram shows the basic setup (figure 8). More observatory details are given at [{Reeve19-2}](#).

I setup three virtual receivers in *SDRuno*, VRX-00, VRX-01, and VRX-02, for the frequencies 19.8, 22.2 and 24.8 kHz, respectively. All virtual receivers ran continuously over the 7-day study period, 3 days before the eclipse (1 December start), eclipse day (4 December) and 3 days after the eclipse (7 December stop). I used the *PWR & SNR to CSV* function to save the measured signal level every 15 seconds to Comma Separated Variable (.csv) files, one file for each virtual receiver. At the end of the observations, the CSV files were uploaded to a PC in the Anchorage Radio Observatory for post-processing and plotting. All plots were produced with Excel.

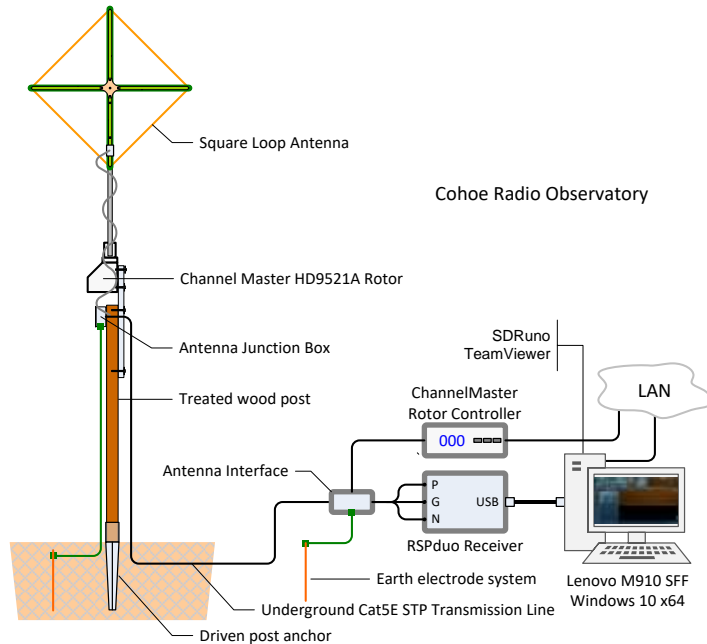

Figure 8 ~ Block diagram of square loop antenna, SDRduo receiver and PC setup at Cohoe Radio Observatory. Not shown are the observatory support infrastructure such as dc power supplies, local area network equipment, NTP time server and uninterruptible power system. The loop antenna diagonal dimension is 1.2 m, and its center is 3.4 m above ground level. The balanced high-impedance (HI-Z) antenna input of the receiver is connected to the antenna through Cat5E STP DB (direct burial) cable. The antenna mast is mounted on a simple TV antenna rotator that is controlled through a web browser. The antenna was set to east-west (090-270° TN) azimuth for the eclipse study. Image © 2021 W. Reeve

The main spectrum and waterfall displayed by SDRUno shows all received signals within the configured frequency span (figure 9). For the measurements discussed in this article, the receiver was set to Zero Intermediate Frequency (ZIF) mode with a sample rate of 2 MHz and factor 32 decimation. These settings provide 62.5 kHz maximum displayed frequency span and FFT frame size of 65 536. In this configuration, the available resolution bandwidth (RBW) settings were 0.95, 1.91, 3.81, 7.63, 15.26 and 30.52 Hz. A low RBW was not necessary for the study, so it was set to 7.63 Hz as a tradeoff between resolution and displayed noise floor smoothness.

In the ZIF mode, the receiver local oscillator (LO) offset can be set automatically by the SDRUno software. I enabled this feature, which provided an LO of 3900 Hz and an initial displayed frequency range of  $-27.35$  to  $+35.15$  kHz. I then used the 4x zoom function to reduce the displayed span to 15.6 kHz and adjusted it to show the range 14.7 to 30.3 kHz.

The receiver IF gain was set to Auto, and the RF gain was set to maximum. It should be noted that the IF and RF gains and the methods for setting them were far from optimized in early versions of the SDRPlay hardware and software. However, SDRPlay made incremental improvements over time so that they now work in a conventional manner. No Noise Reduction (NR) or Noise Blanker (NB) was used. Although not relevant to this study, the demodulation mode was set to CW with 700 Hz offset and 150 Hz bandwidth.

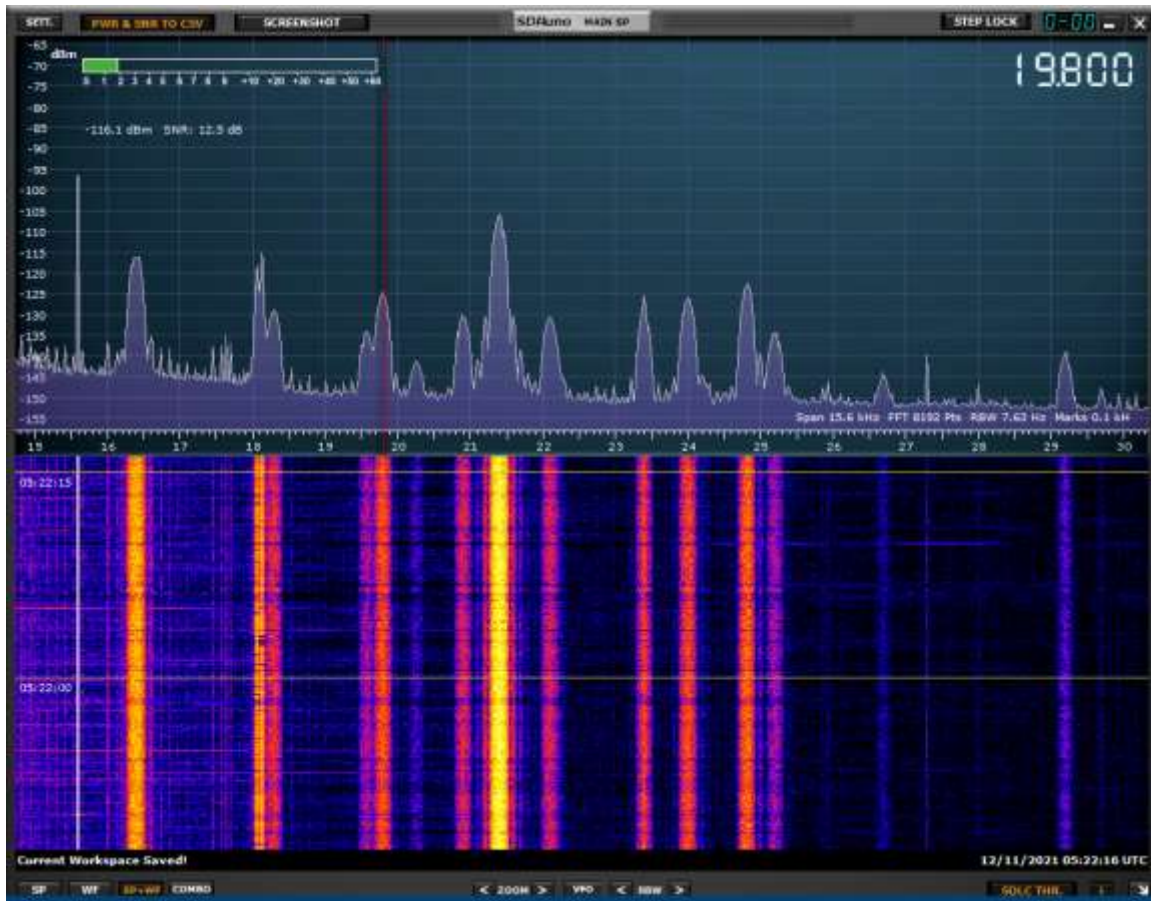

Figure 9 ~ Spectrum and waterfall for 11 December 2021 (a week after the eclipse) showing receiver tuned to the NWC station on 19.8 kHz and with the loop antenna oriented east-west. The tuning is marked by the red vertical line in the upper panel. The span is 15.6 kHz with 7.63 Hz resolution bandwidth. Many VLF signals are present including JJI (22.2 kHz) and NLK (24.8 kHz). Note that JJI is very weak and almost hidden behind a stronger signal at 22.1 kHz. The strongest signal at the time of this image is station NPM in Hawaii USA at 21.4 kHz. Other signals are (with presumed station ID in parentheses, see [VLFStaLst](#)): 16.4 (JXN), 18.1 (RDL), 18.3 (HWU), 19.6 (GBZ), 20.3 (ICV), 20.9 (HWU), 23.4 (DHO38), 24.0 (NAA), 24.8 (NLK), 25.2 (NML), 26.7 (TBB), and 29.2 (Unknown) kHz. The very narrow spectrum spikes are spurious signals including harmonics of 60 Hz powerline interference. Image from SDRuno.

## 7. References & Weblinks

- {[Reeve19-1](#)} Reeve, W., Monitoring Low Frequency Propagation with a Software Defined Radio Receiver, Part I ~ Concepts, 2019, available at: [http://www.reeve.com/Documents/Articles%20Papers/Propagation/Reeve\\_LFProp-ConceptsP1.pdf](http://www.reeve.com/Documents/Articles%20Papers/Propagation/Reeve_LFProp-ConceptsP1.pdf)
- {[Reeve19-2](#)} Reeve, W., Monitoring Low Frequency Propagation with a Software Defined Radio Receiver, Part II ~ Observations, 2019, available at: [http://www.reeve.com/Documents/Articles%20Papers/Propagation/Reeve\\_LFProp-ObsvP2.pdf](http://www.reeve.com/Documents/Articles%20Papers/Propagation/Reeve_LFProp-ObsvP2.pdf)
- {[Reeve21](#)} Reeve, W., Comparison of Signals from South and West VLF Stations During June 2021, available at: [https://reeve.com/Documents/Articles%20Papers/Reeve\\_Comp\\_VLFSta\\_Jun2021\\_SARA.pdf](https://reeve.com/Documents/Articles%20Papers/Reeve_Comp_VLFSta_Jun2021_SARA.pdf)

{DXView} <http://www.dxlabsuite.com/dxview/>  
{Kyoto} <http://wdc.kugi.kyoto-u.ac.jp/igrf/gggm/>  
{NASA4Dec} <https://eclipse.gsfc.nasa.gov/SEplot/SEplot2001/SE2021Dec04T.GIF>  
{NASA-AN} <https://eclipse.gsfc.nasa.gov/SEanimate/SEanimate2001/SE2021Dec04T.GIF>  
{NASA-DEC} <https://eclipse.gsfc.nasa.gov/SEdecade/SEdecade2021.html>  
{NASA-SE} <https://eclipse.gsfc.nasa.gov/>  
{NASAKey} <https://eclipse.gsfc.nasa.gov/SEplot/SEplotkey.html>  
{TD4Dec} <https://www.timeanddate.com/eclipse/globe/2021-december-4>  
{TimeDate} <https://www.timeanddate.com/eclipse/>  
{VLFStaLst} [https://reeve.com/Documents/Articles%20Papers/Reeve\\_VLF-LFStationList.pdf](https://reeve.com/Documents/Articles%20Papers/Reeve_VLF-LFStationList.pdf)

---



**Author:** Whitham Reeve obtained B.S. and M.S. degrees in Electrical Engineering at University of Alaska Fairbanks, USA. He worked as a professional engineer and engineering firm owner/operator in the airline and telecommunications industries for more than 40 years and now manufactures electronic equipment used in radio astronomy. He also is a part-time space weather advisor for the High-frequency Active Auroral Research Program (HAARP) and a member of the HAARP Advisory Committee. He has lived in Anchorage, Alaska his entire life. Email contact: [whitreeve@gmail.com](mailto:whitreeve@gmail.com)

---

## Observation Reports

### Special Note:

These observation reports are from SARA members and have not been verified by peer review.

These observations are included in the journal to allow for discussion on improving the SARA member's observation system.

Some observations may be **false positives**, therefore the SARA staff requests that recommendations to improve the observation be addressed directly to the author.

#### Coronal Mass Ejection (CME) Causes Sudden Frequency Deviations (SFD) of $\pm 2$ Hz at 15 and 25 MHz Whitham D. Reeve, Anchorage, Alaska

Space Weather Prediction Center, Forecast Discussion: At 2138 UTC on 1 February 2022, ACE RTSW (Real-Time Solar Wind) data indicated the anticipated arrival of a CME from 29 January. Solar wind speeds increased impulsively from  $\sim 360 \text{ km s}^{-1}$  to  $\sim 475 \text{ km s}^{-1}$ . Total field Bt increased from  $\sim 5 \text{ nT}$  to  $12 \text{ nT}$  in a matter of minutes.... The geomagnetic field was quiet until 2221 UTC when a Sudden Impulse was detected at the Honolulu geomagnetic observatory with a maximum deviation of  $22 \text{ nT}$ . This was in response to anticipated CME shock arrival and caused a response to active levels during the day's final (3 h) synoptic period.

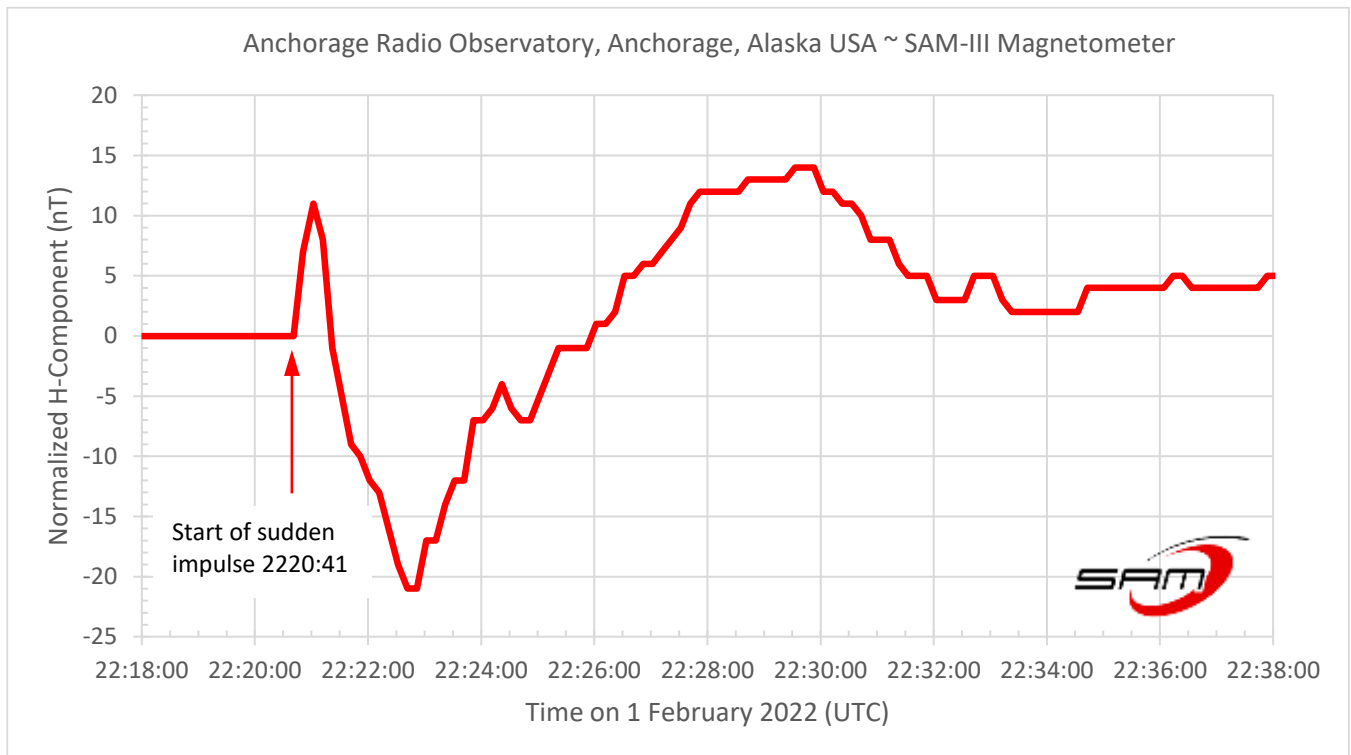



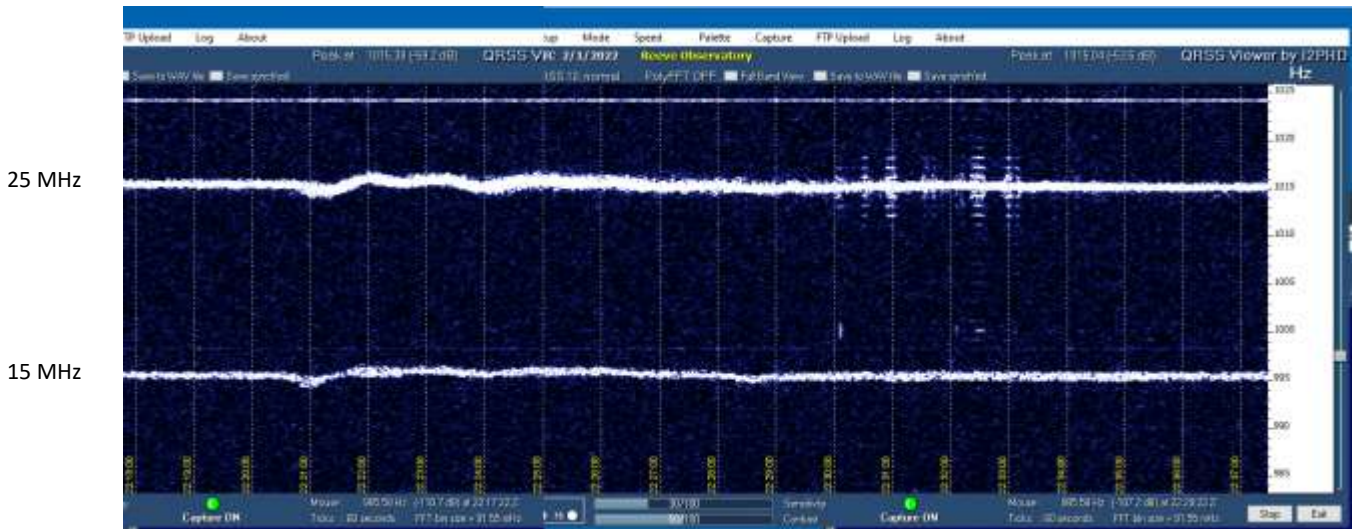

Discussion:

- ⚙ Signal sources (location, distance): WWV-15, WWV-25 (Colorado, 3800 km) and WWVH-15 (Hawaii, 4400 km);
- ⚙ Phenomena: Rapid compression of the geomagnetosphere adds heat and alters ionosphere altitude, changing propagation path length and wave number. This CME-induced SFD is unusual in that SFDs usually are caused in real-time by solar flares. See For further reading;
- ⚙ Geomagnetic field: Sudden impulse amplitude 11 nT at Anchorage; ended up being sudden storm commencement (SSC) because a geomagnetic storm followed and continued for several days;
- ⚙ Observatory was on the sunlit side of Earth; event occurred between 1:20 and 1:24 pm Alaska DST.

Instrumentation at Anchorage Radio Observatory:

- ⚙ Magnetometer settings: 0.1 Hz sample rate.  $H = \sqrt{(X^2 + Y^2)}$
- ⚙ Receiver settings: LSB, Receiver tuning 15.000 995 and 25.001 015 MHz, AGC off. Argo software.

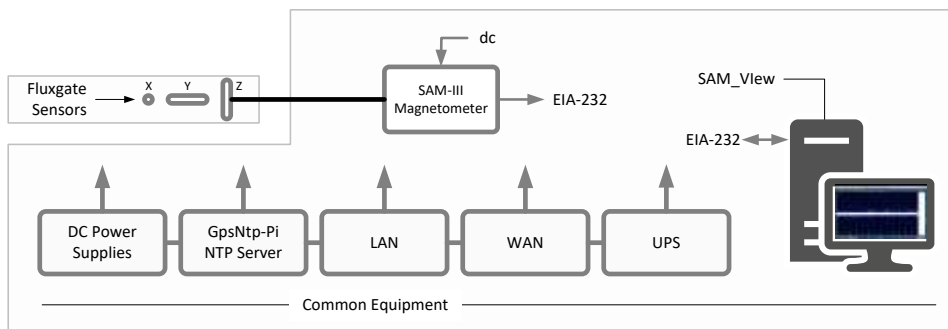

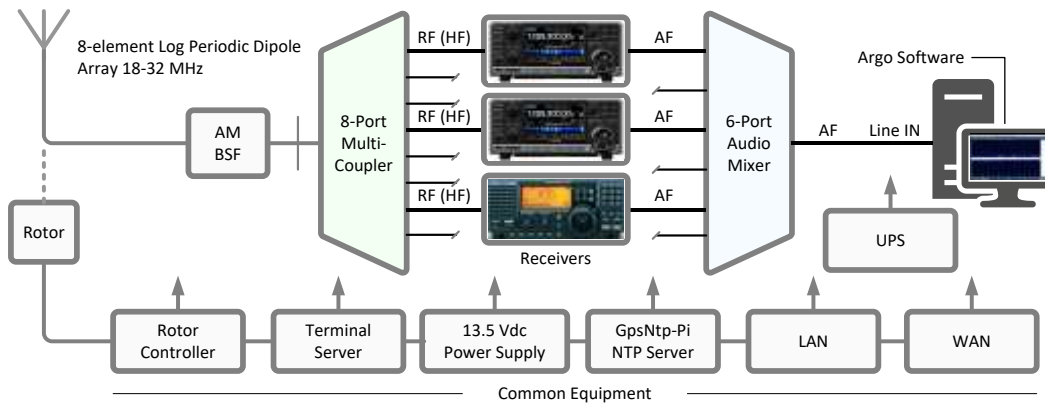

For further reading:

- ⚙ [https://www.reeve.com/Documents/Articles%20Papers/Propagation%20Anomalies/Reeve\\_SuddenFreqDev\\_Concepts\\_P1.pdf](https://www.reeve.com/Documents/Articles%20Papers/Propagation%20Anomalies/Reeve_SuddenFreqDev_Concepts_P1.pdf)
- ⚙ [https://www.reeve.com/Documents/Articles%20Papers/Propagation%20Anomalies/Reeve\\_SuddenFreqDev\\_Meas\\_P2.pdf](https://www.reeve.com/Documents/Articles%20Papers/Propagation%20Anomalies/Reeve_SuddenFreqDev_Meas_P2.pdf)

## Observation Report

### Meteor Detection - Peak of 2022 Quadrantids Meteor Shower

James H. Van Prooyen, N8PQK

There are a number of SARA members doing meteor observation (some time called Meteor Scatter). Shown below is what we believe to be the maximum point of the Quadrantids Meteor Shower; it was predicted to be at 21:00 UT (4 PM ET). From the data show below it appears to be between 23:10 and 23:20 UT (1-3-2022). This meteor shower is known for its maximum point having a very short duration.

These observations use one of several HF stations that are available. You may also want to look at Whitham Reeve's Journal article "Sample of HF Meteor Trail Reflections Observed at Anchorage, Alaska USA"; SARA Journal February 2021 page 49 for additional information. Software: HOFFT 1.0.0f Receiver: TenTek 320 Antenna: MFJ Mini Dipole, 40 feet above ground You can find more detail on this meteor shower here:

<https://earthsky.org/astronomy-essentials/everything-you-need-to-know-quadrantid-meteor-shower>

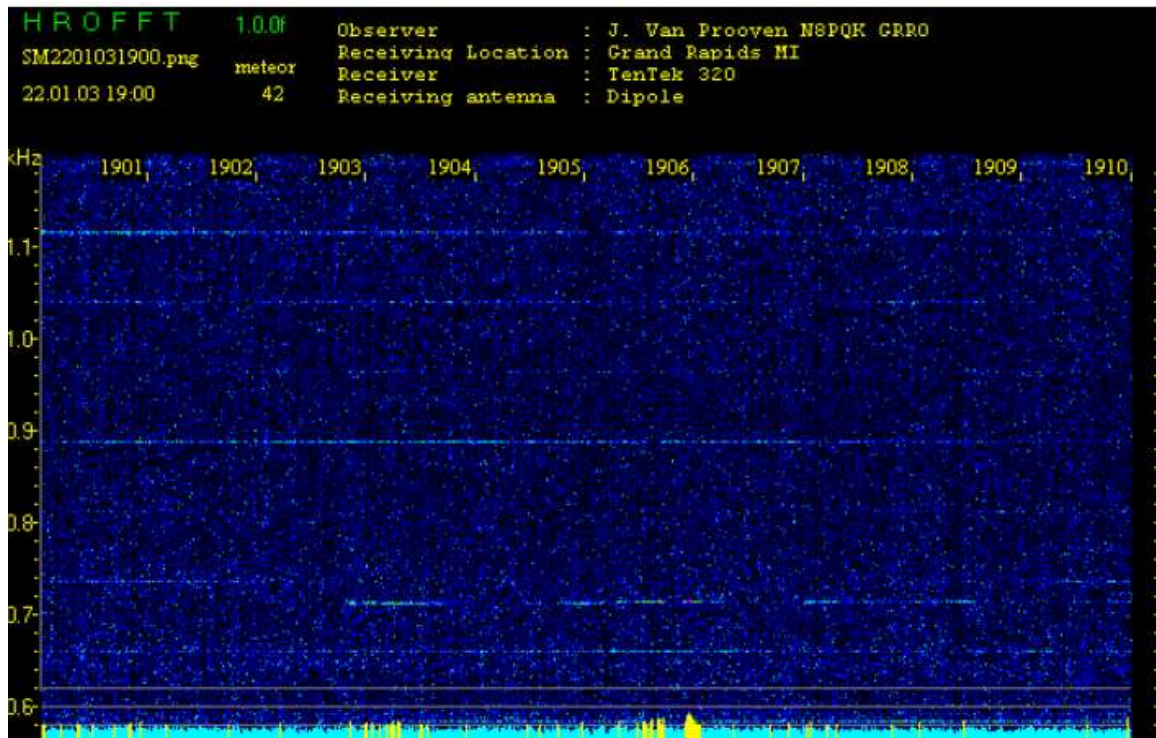



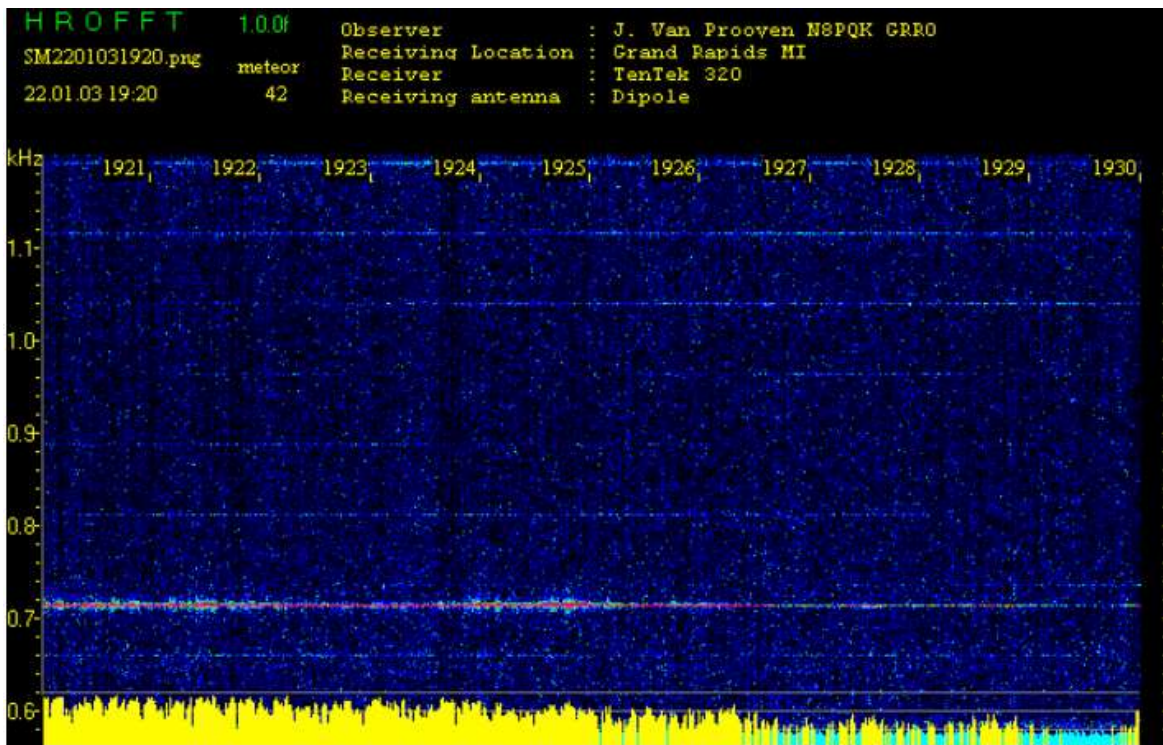
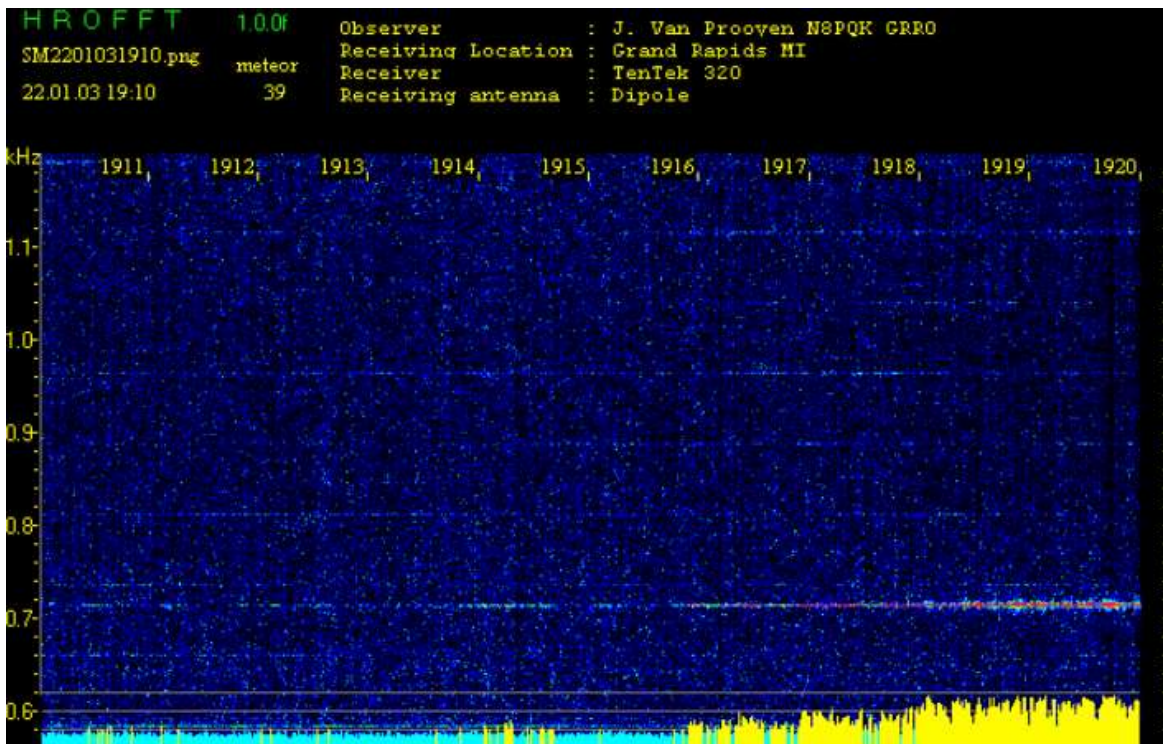

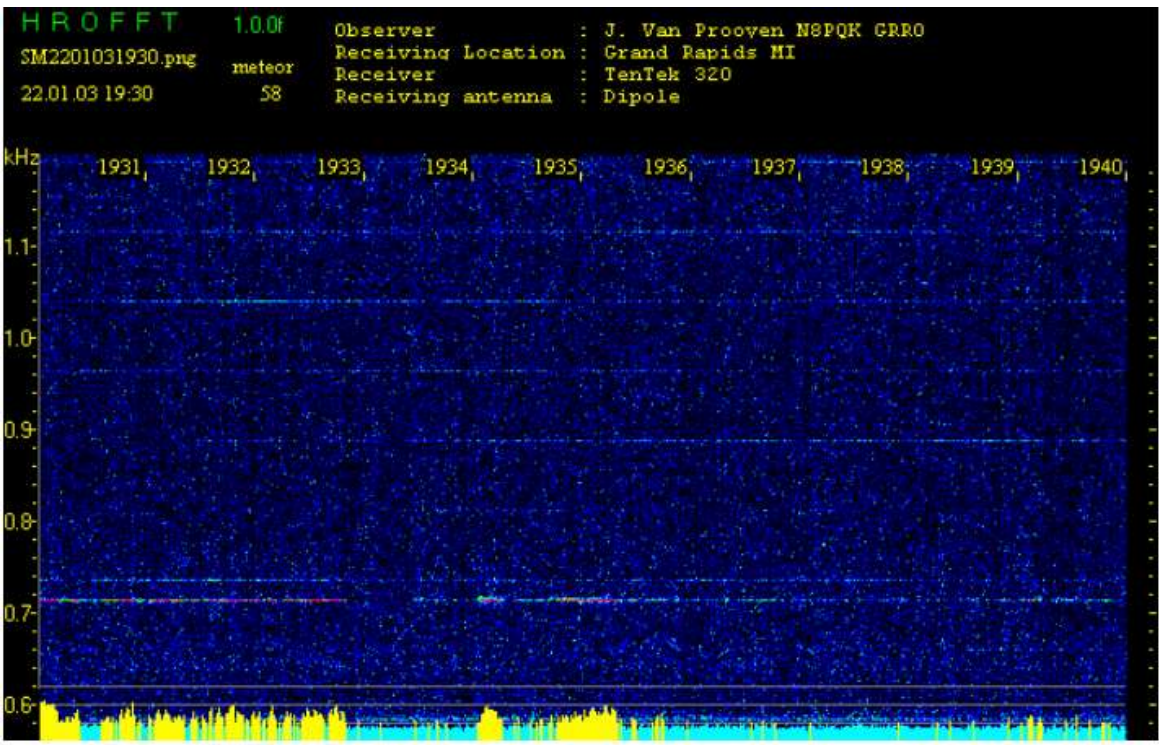

## Membership

### New Members

Please welcome our new or returning SARA members who have joined since the last journal. If your name is missing or misspelled, please send an email to [treas@radio-astronomy.org](mailto:treas@radio-astronomy.org). We will make sure it appears correctly in the next Journal issue.

First name	Last name	City	State	Country	Call Sign
Mark	Price	Laguna Hills	CA	USA	KJ6YXR
Stephen	Lonsdale	Ely	Cambridgeshire	UK	
Christopher	Porada	Winston Salem	NC	USA	
Jeremy	Waller	Cockatoo Valley		Australia	VK5WJ
Lyndon	Harris	Zirconia	NC	USA	KO4VDP
Tisha	Hayes	Gadsden	AL	USA	
Scott	Voss	Custer	WA	USA	AI7CD
George	DeTar	Longmont	CO	USA	
Frank	Eliot	Washington	DC	USA	W3WAG
Neill	Alford III	Virginia Beach	VA	USA	
Alan	Ames	Albuquerque	NM	USA	N2ALE
Terrence	Tarlton	Pickerington	OH	USA	
Robin	Kidd	Peachtree Corners	GA	USA	
Mark	Dittmar	Cincinnati	OH	USA	AB0CW
Ryan	McKnight	Rockbridge	OH	USA	
Danijel	Bosnjak	Zagreb		Croatia	9A5ELO
Deborah	Scherrer	Castro Valley	CA	USA	
Brett	Dawson	Cooma	NSW	Australia	
Keith	Miller	Taos	NM	USA	
Mike	Thompson	Wenonah	NJ	USA	KG4JYA
Rolando	Fernandez	San Juan	PR	USA	
Keith	Butterworth	Worthing		UK	
Joshua	Sepodi	Terre Haute	IN	USA	
Isabel	Sepodi	Terre Haute	IN	USA	
Nathan	Rodland	Austin	TX	USA	KI5NZE
Richard	Marsden	Wichita Falls	TX	USA	
Joshua	Sperrick	Corning	NY	USA	
Martin	Knoblauch	Philadelphia	PA	USA	N3BEV

Membership dues are \$20.00 US per year and all dues expire in June. Student memberships are \$5.00 US per year. Memberships must be renewed in June of each year. Or pay once and never worry about missing your dues again with the SARA Life Membership. SARA Life Memberships are now offered for a one-time payment of twenty times the basic annual membership fee (currently \$400 US).



## Journal Archives & Other Promotions

The rich and diverse legacy of member contributed content is available in the SARA Journal Archives. Table of contents for journals is available online at [radio-astronomy.org/store](http://radio-astronomy.org/store).

The entire set of The Journal of The Society of Amateur Radio Astronomers is available on USB drive. It goes from the beginning of 1981 to the end of 2017 (over 6000 pages of SARA history!) Or you can choose one of the following USB drive's or DVD:\* (Prices are US dollars and include postage.)

†All SARA journals and conference proceedings are available through the previous calendar year.

Prices, US dollars, including postage

### Members

Each USB drive	\$15.00
USB drive + 1-year membership extension	\$30.00

### Non-members

Each USB drive	\$25.00
USB drive + 1-year membership	\$30.00

### Non-USA members

Each USB drive	\$20.00 (airmail)
USB drive+ 1-year members extension	\$35.00

\*Already a member and want any or all these USB drives or DVD's? Buy any one for \$15.00 or get any three for \$35.00.

SARA Store ([radio-astronomy.org/store](http://radio-astronomy.org/store).)

SARA offers the above USB drives, DVDs, printed Proceedings and Proceedings on USB drive and other items at the SARA Store: <http://www.radio-astronomy.org/e-store>. Proceeds from sales go to support the student grant program. Members receive an additional 10% discount on orders over \$50 US. Payments can be made by sending payment by PayPal to [treas@radio-astronomy.org](mailto:treas@radio-astronomy.org) or by mailing a check or money order to SARA, c/o Brian O'Rourke, 337 Meadow Ridge Rd, Troy, VA 22974-3256

### SARA Online Discussion Group

SARA members participate in the online forum at <http://groups.google.com/group/sara-list>. This is an invaluable resource for any amateur radio astronomer.

### SARA Conferences

SARA organizes multiple conferences each year. Participants give talks, share ideas, attend seminars, and get hands-on experience. For more information, visit <http://www.radio-astronomy.org/meetings>.

### Facebook

Like SARA on Facebook

<http://www.facebook.com/pages/Society-of-Amateur-Radio-Astronomers/128085007262843>

### Twitter

Follow SARA on Twitter@RadioAstronomy1

## What is Radio Astronomy?

This link is for a booklet explaining the basics of radio astronomy.

<http://www.radio-astronomy.org/pdf/sara-beginner-booklet.pdf>

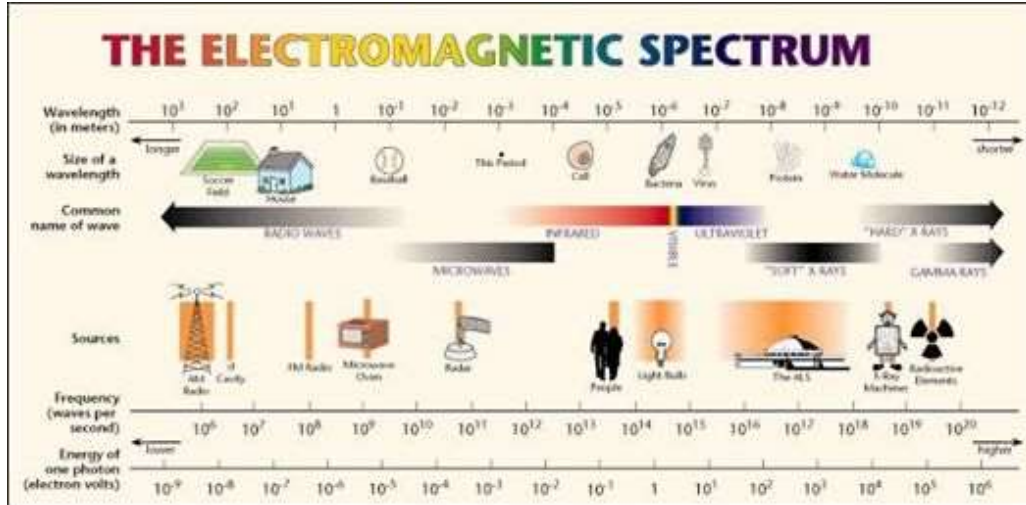

## Administrative

### Officers, directors, and additional SARA contacts

The Society of Amateur Radio Astronomers is an all-volunteer organization. The best way to reach people on this page is by email with SARA in the subject line SARA Officers.

President: Dennis Farr, WB4RJK, <https://www.radio-astronomy.org/contact/President> +1 813 833-3918

Vice President: Dr. Rich Russel, AC0UB <https://www.radio-astronomy.org/contact/Vicepresident>

Secretary: Bruce Randall, NT4RT, <https://www.radio-astronomy.org/contact/Secretary> +1 803-327-3325

Treasurer: Brian O'Rourke, K4UL, <https://www.radio-astronomy.org/contact/Treasurer>

Past President: Ken Redcap, [tbd@radio-astronomy.org](mailto:tbd@radio-astronomy.org) +1 319-591-1131

Founder Emeritus and Director: Jeffrey M. Lichtman, K14GIY, [jeff@radioastronomysupplies.com](mailto:jeff@radioastronomysupplies.com) +1 954-554-3739

### Board of Directors

Name	Term expires	Email
Ed Harfmann	2022	<a href="mailto:edharfmann@comcast.net">edharfmann@comcast.net</a>
Dr. Wolfgang Herrmann	2023	<a href="mailto:messbetrieb@astropeiler.de">messbetrieb@astropeiler.de</a>
Tom Jacobs	2023	<a href="mailto:tdj0@bellsouth.net">tdj0@bellsouth.net</a>
Charles Osborne	2023	<a href="mailto:k4cso@twc.com">k4cso@twc.com</a>
Keith Payea	2022	<a href="mailto:kbpayea@bryantlabs.net">kbpayea@bryantlabs.net</a>
Steve Tzikas	2022	<a href="mailto:Tzikas@alum.rpi.edu">Tzikas@alum.rpi.edu</a>
Jon Wallace	2023	<a href="mailto:wallacefj@comcast.net">wallacefj@comcast.net</a>
David Westman	2022	<a href="mailto:david.westman@engineeringretirees.org">david.westman@engineeringretirees.org</a>

**Other SARA Contacts**

All Officers	<a href="http://www.radio-astronomy.org/contact-sara">http://www.radio-astronomy.org/contact-sara</a>	
All Directors and Officers	<a href="http://www.radio-astronomy.org/contact/All-Directors-and-Officers">http://www.radio-astronomy.org/contact/All-Directors-and-Officers</a>	
Eastern Conference Coordinator	<a href="http://www.radio-astronomy.org/contact/Annual-Meeting">http://www.radio-astronomy.org/contact/Annual-Meeting</a>	
All Radio Astronomy Editors	<a href="http://www.radio-astronomy.org/contact/Newsletter-Editor">http://www.radio-astronomy.org/contact/Newsletter-Editor</a>	
Radio Astronomy Editor	Dr. Richard A. Russel	<a href="mailto:drrichrussel@netscape.net">drrichrussel@netscape.net</a>
Contributing Editor	Whitham D. Reeve	<a href="mailto:whitreeve@gmail.com">whitreeve@gmail.com</a>
Educational Outreach	<a href="http://www.radio-astronomy.org/contact/Educational-Outreach">http://www.radio-astronomy.org/contact/Educational-Outreach</a>	
Grant Committee	Tom Crowley	<a href="mailto:grants@radio-astronomy.org">grants@radio-astronomy.org</a>
Membership Chair	<a href="http://www.radio-astronomy.org/contact/Membership-Chair">http://www.radio-astronomy.org/contact/Membership-Chair</a>	
Technical Queries (David Westman)	<a href="http://www.radio-astronomy.org/contact/Technical-Queries">http://www.radio-astronomy.org/contact/Technical-Queries</a>	
Webmaster	Ciprian (Chip) Sufitchi, N2YO	<a href="mailto:webmaster@radio-astronomy.org">webmaster@radio-astronomy.org</a>

## Resources

### Great Projects to Get Started in Radio Astronomy

#### Radio Observing Program

The Astronomical League (AL) is starting a radio astronomy observing program. If you observe one category, you get a Bronze certificate. Silver pin is two categories with one being personally built. Gold pin level is at least four categories. (Silver and Gold level require AL membership which many clubs have membership. For the bronze level, you need not be a member of AL.)

Categories include

- 1) SID
- 2) Sun (aka IBT)
- 3) Jupiter (aka Radio Jove)
- 4) Meteor back-scatter
- 5) Galactic radio sources

This program is a collaboration between NRAO and AL. Steve Boerner is the Lead Coordinator and a SARA member.

For more information:

Steve Boerner

2017 Lake Clay Drive

Chesterfield, MO 63017

Email: [sboerner@charter.net](mailto:sboerner@charter.net)

Phone: 636-537-2495

<http://www.astroleague.org/programs/radio-astronomy-observing-program>

#### Radio Jove



The Radio Jove Project monitors the storms of Jupiter, solar activity and the galactic background. The radio telescope can be purchased as a kit or you can order it assembled. They have a terrific user group you can join. <http://radiojove.gsfc.nasa.gov/>

## INSPIRE Program



The INSPIRE program uses build-it-yourself radio telescope kits to measure and record VLF emissions such as tweeks, whistlers, sferics, and chorus along with man-made emissions. This is a very portable unit that can be easily transported to remote sites for observations.

<http://theinspireproject.org/default.asp?contentID=27>

## SARA/Stanford SuperSID



Stanford Solar Center and the Society of Amateur Radio Astronomers have teamed up to produce and distribute the SuperSID (Sudden Ionospheric Disturbance) monitor. The monitor utilizes a simple pre-amp to magnify the VLF radio signals which are then fed into a high definition sound card. This design allows the user to monitor and record multiple frequencies simultaneously. The unit uses a compact 1-meter loop antenna that can be used indoors or outside. This is an ideal project for the radio astronomer that has limited space. To request a unit, send an e-mail to [supersid@radio-astronomy.org](mailto:supersid@radio-astronomy.org)

## Radio Astronomy Online Resources

AJ4CO Observatory – Radio Astronomy Website: <a href="http://www.aj4co.org/">http://www.aj4co.org/</a>	National Radio Astronomy Observatory <a href="http://www.nrao.edu">http://www.nrao.edu</a>
Radio Astronomy calculators <a href="https://www.aj4co.org/Calculators/Calculators.html">https://www.aj4co.org/Calculators/Calculators.html</a>	NRAO Essential Radio Astronomy Course <a href="http://www.cv.nrao.edu/course/astr534/ERA.shtml">http://www.cv.nrao.edu/course/astr534/ERA.shtml</a>
Introduction to Amateur Radio Astronomy (presentation) <a href="http://www.aj4co.org/Publications/Intro%20to%20Amateur%20Radio%20Astronomy,%20Typinski%20(AAC,%202016)%20v2.pdf">http://www.aj4co.org/Publications/Intro%20to%20Amateur%20Radio%20Astronomy,%20Typinski%20(AAC,%202016)%20v2.pdf</a>	Exotic Ions and Molecules in Interstellar Space -- ORION 2020 10 21. Dr. Bob Compton <a href="https://www.youtube.com/watch?v=r6cKhp23SUo&amp;t=5s">https://www.youtube.com/watch?v=r6cKhp23SUo&amp;t=5s</a>
RF Associates Richard Flagg, rf@hawaii.rr.com 1721-1 Young Street, Honolulu, HI 96826	The Radio JOVE Project & NASA Citizen Science – ORION 2020.6.17. Dr. Chuck Higgins <a href="https://www.youtube.com/watch?v=s6eWAXjywp8&amp;t=5s">https://www.youtube.com/watch?v=s6eWAXjywp8&amp;t=5s</a>
RFSpace, Inc. <a href="http://www.rfspace.com">http://www.rfspace.com</a>	UK Radio Astronomy Association <a href="http://www.ukraa.com/">http://www.ukraa.com/</a>
CALLISTO Receiver & e-CALLISTO <a href="http://www.reeve.com/Solar/e-CALLISTO/e-callisto.htm">http://www.reeve.com/Solar/e-CALLISTO/e-callisto.htm</a>	CALLISTO software and data archive: <a href="http://www.e-callisto.org">www.e-callisto.org</a>
Deep Space Exploration Society <a href="http://DSES.science">http://DSES.science</a>	Radio Astronomy Supplies <a href="http://www.radioastronomysupplies.com">http://www.radioastronomysupplies.com</a>
Deep Space Object Astrophotography Part 1 -- ORION 2021 02 17. George Sradnov <a href="https://www.youtube.com/watch?v=Pm_Rs17KIyQ">https://www.youtube.com/watch?v=Pm_Rs17KIyQ</a>	Radio Jove Spectrograph Users Group <a href="http://www.radiojove.org/SUG/">http://www.radiojove.org/SUG/</a>
European Radio Astronomy Club <a href="http://www.era.net">http://www.era.net</a>	Radio Sky Publishing <a href="http://radiosky.com">http://radiosky.com</a>
British Astronomical Association – Radio Astronomy Group <a href="http://www.britastro.org/baa/">http://www.britastro.org/baa/</a>	The Arecibo Radio Telescope; It's History, Collapse, and Future - ORION 2020.12.16. Dr. Stan Kurtz, Dr. David Fields <a href="https://www.youtube.com/watch?v=rBZIPOLNX9E">https://www.youtube.com/watch?v=rBZIPOLNX9E</a>
Forum and Discussion Group <a href="http://groups.google.com/group/sara-list">http://groups.google.com/group/sara-list</a>	Shirleys Bay Radio Astronomy Consortium <a href="mailto:marcus@propulsionpolymers.com">marcus@propulsionpolymers.com</a>
GNU Radio <a href="https://www.gnuradio.org/">https://www.gnuradio.org/</a>	SARA Twitter feed <a href="https://twitter.com/RadioAstronomy1">https://twitter.com/RadioAstronomy1</a>
SETI League <a href="http://www.setileague.org">http://www.setileague.org</a>	SARA Web Site <a href="http://radio-astronomy.org">http://radio-astronomy.org</a>
NRAO Essential Radio Astronomy Course <a href="http://www.cv.nrao.edu/course/astr534/ERA.shtml">http://www.cv.nrao.edu/course/astr534/ERA.shtml</a>	SARA Facebook page <a href="https://www.facebook.com/pages/Society-of-Amateur-Radio-Astronomers/128085007262843">https://www.facebook.com/pages/Society-of-Amateur-Radio-Astronomers/128085007262843</a>
NASA Radio JOVE Project <a href="http://radiojove.gsfc.nasa.gov">http://radiojove.gsfc.nasa.gov</a> Archive: <a href="http://radiojove.org/archive.html">http://radiojove.org/archive.html</a>	Simple Aurora Monitor: Magnetometer <a href="http://www.reeve.com/SAMDescription.htm">http://www.reeve.com/SAMDescription.htm</a>
National Radio Astronomy Observatory <a href="http://www.nrao.edu">http://www.nrao.edu</a>	Stanford Solar Center <a href="http://solar-center.stanford.edu/SID/">http://solar-center.stanford.edu/SID/</a>
A New Radio Telescope for Mexico - ORION 2021 01 20. Dr. Stan Kurtz <a href="https://www.youtube.com/watch?v=Q9aBWr1aBVc">https://www.youtube.com/watch?v=Q9aBWr1aBVc</a>	



## For Sale, Trade and Wanted

At the SARA online store: [radio-astronomy.org/store](http://radio-astronomy.org/store).

### SARA Polo Shirts

New SARA shirts have arrived.

We now have a good selection of X, XX, and XXX shirts available in all colors including white! Shirts are \$20 at the conference and \$25 shipped.

Contact the treasurer at [treas@radio-astronomy.org](mailto:treas@radio-astronomy.org) for availability and shipping.



### Scope in a Box \$295

[radio-astronomy.org/store](http://radio-astronomy.org/store).

Kit of parts and software to build a working Radio Telescope to detect Hydrogen Line emissions. Available to USA addresses only at this time.

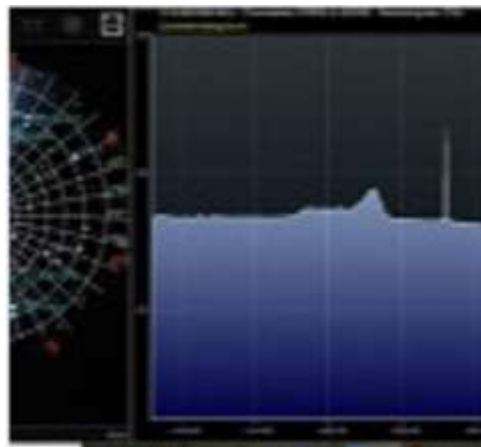

**SuperSID Complete Kit (\$112-\$160 depending on options)**

[radio-astronomy.org/store](http://radio-astronomy.org/store).



**SARA Publication, Journals and Conference Proceedings (various prices)**

[radio-astronomy.org/store](http://radio-astronomy.org/store).

**SARA Journal USB Drive (\$15-\$35 depending on shipping option)**

[radio-astronomy.org/store](http://radio-astronomy.org/store).

The USB drive covers the society journal "Radio Astronomy" from the founding of the organization in 1981 thru 2020. Articles cover a wide range of topics including: cosmic radiation, pulsars, quasars, meteor detection, solar observing, Jupiter, Radio Jove, gamma ray bursts, the Itty Bitty Telescope (IBT), dark matter, black holes, the Jansky antenna, methanol masers, mapping at 408 MHz and more. This CD contains all of the above and more with over 4800 pages of articles on radio astronomy. Also included is a copy of Grote Reber's handwritten, 34 page document "Carriage and Mirror Detail" of his historic antenna now on display at the National Radio Astronomy Observatory (NRAO) in Green bank, WV. You also get an electronic copy of the 109 page "Basics of Radio Astronomy" from JPL Goldstone-Apple Valley Radio Telescope. Also included is the NRAO 40-foot radio telescope "Operators Manual", which by the way, you get to operate if you attend the Eastern SARA conference in July.

## SARA Advertisements

There is no charge to place an ad in Radio Astronomy; but you must be a current SARA member. Ads must be pertinent to radio astronomy and are subject to the editor's approval and alteration for brevity. Please send your "For Sale," "Trade," or "Wanted" ads to [edit@radio-astronomy.org](mailto:edit@radio-astronomy.org). Please include email and/or telephone contact information. Please keep your ad text to a reasonable length. Ads run for one bimonthly issue unless you request otherwise.

### **Radio-Astro-Machine, [zlblac@gmail.com](mailto:zlblac@gmail.com)**

Elevation rotation adapter plate for Scope in a Box and custom machining. For further information visit <https://radio-astro-machine.wixsite.com/my-site> or send an email.

### **Typinski Radio Astronomy, Inc., [info@typinski.com](mailto:info@typinski.com)**

Antenna systems and feed line components for HF radio astronomy

### **Jeff Kruth, WA3ZKR, [kmec@aol.com](mailto:kmec@aol.com)**

RF components from HF to MMW, various types including mixers, RF switches, amplifiers, oscillators, coaxial components, waveguide components, etc. I have a very large collection of stuff and the facilities to test and provide data. Please email with your needs and I will see if I have something for you. Have fun!

### **Stuart and Lorraine Rumley, [sales@valontechnology.com](mailto:sales@valontechnology.com)**

The Valon Technology 2100 Downconverter, when combined with our 5009 frequency synthesizer module, provides a high-performance, compact receiver downconverter system. Applications include hydrogen line studies at 1420MHz and radio astronomy in the protected 30MHz segment of the 21 cm band. For more information visit <http://www.valontechnology.com/2100downconverter.html> or send an email.

### **Radio2Space, [filippo.bradaschia@primalucelab.com](mailto:filippo.bradaschia@primalucelab.com)**

SPIDER radio telescopes and turn-key-systems designed specifically for education.

<https://www.radio2space.com>

We developed our SPIDER radio telescopes as turn-key-system just to avoid the problem you perfectly highlighted in your website: "Purchasing a radio telescope isn't like buying an optical telescope. They are harder to find, and usually require assembly and software troubleshooting. In some cases, a radio telescope must be built from components." Our SPIDER radio telescopes are not designed for amateurs that prefer to build a radio telescope but to schools, universities, museums, and other science institutes that needs for a complete and ready-to-use system, just like the optical telescopes they can normally buy!

### **Radio Astronomy Supplies**

<http://www.radioastronomysupplies.com>

[jeff@radioastronomysupplies.com](mailto:jeff@radioastronomysupplies.com)

Research and Educational Radio Telescopes and all associated equipment since 1994

### Membership Information

Annual SARA dues Individual \$20, Classroom \$20, Student \$5 (US funds) anywhere in the world. Membership includes a subscription to Radio Astronomy, the bimonthly Journal of The Society of Amateur Radio Astronomers, delivered electronically (via a secure web link, emailed to you as each new issue is posted). We regret that printing and postage costs prevent SARA from providing hardcopy subscriptions to our Journal.

We would appreciate the following information included with your check or money order, made payable to SARA:

Name: \_\_\_\_\_  
 Email Address: \_\_\_\_\_  
(required for electronic Journal delivery)  
 Ham call sign: \_\_\_\_\_ (if applicable)  
 Address: \_\_\_\_\_  
 City: \_\_\_\_\_  
 State: \_\_\_\_\_  
 Zip: \_\_\_\_\_  
 Country: \_\_\_\_\_  
 Phone: \_\_\_\_\_

Please include a note of your interests. Send your application for membership, along with your remittance, to our Treasurer.

For further information, see our website at: <http://radio-astronomy.org/membership>



### How to get started?

SARA has a made a kit of software and parts to detect the Hydrogen line signal from space. This is an excellent method to get started in radio astronomy. It teaches the principles of antenna design, signal detection, and signal processing. Read more about this and other projects on our web site.

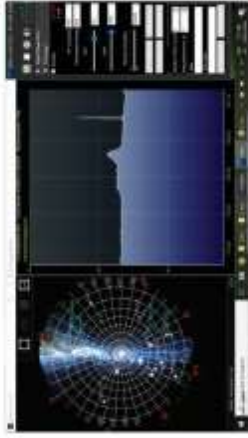

Membership supported, nonprofit [501(c) (3)]  
 Educational and Radio Astronomy Organization  
**Knowledge through Common Research,  
 Education and Mentoring**



SARA members have been privileged to use this forty foot diameter drift-scan hydrogen line radio telescope every year at their annual meeting in Green Bank.

<http://radio-astronomy.org>

### Why Radio Astronomy?

Because about sixty five percent of our current knowledge of the universe has stemmed from radio astronomy alone. The discovery of quasars, pulsars, black holes, the 3K background from the "Big Bang" and the discovery of biochemical hydrogen/carbon molecules are all the result of professional radio astronomy.





## The Society of Amateur Radio Astronomers

SARA was founded in 1981, with the purpose of educating those interested in pursuing amateur radio astronomy.

The society is open to all, wishing to participate with others, worldwide.

SARA members have many interests, some are as follows:

### SARA Areas of Study and Research:

- Solar Radio Astronomy
- Galactic Radio Astronomy
- Meteor Detection
- Jupiter
- SETI
- Gamma Ray/High Energy Pulse Detection
- Antennas
- Design of Hardware / Software

The members of the society offer a friendly mentor atmosphere. All questions and inquiries are answered in a constructive manner. No question is silly!

SARA offers its members an electronic bi-monthly journal entitled Radio Astronomy. Within the journal, members report on their research and observations. In addition, members receive updates on the professional radio astronomy community and, society news.

Once a year SARA meets for a three-day conference at the Green Bank Observatory in Green Bank West Va.

There is also a spring conference held at various cities in the Western USA. Previous meetings have been at the VLA in Socorro, NM and at Stanford University.



### How do amateurs do radio astronomy?

Radio astronomy by amateurs is conducted using antennas of various shapes and sizes, from smaller parabolic dishes to simple wire antennas. These antennas are connected to receivers and most of these receivers are software defined radios these days. Data from the receivers are collected by computers, and the received signals will be displayed as charts, graphs or maybe even sky maps. As diverse as the observed objects, so is the instruments and tools used. SARA members will always be supportive to find good solutions for what one wishes to observe.

### Is amateur radio astronomy instrumentation expensive?

Technical information freely circulated in our monthly journal helps amateurs to obtain good low noise equipment from off the shelf assemblies, or to build their own units. The actual cash investment in radio astronomy equipment need not exceed that of any other hobby.

### What are amateurs actually looking for in the received data?

The aim of the radio amateur is to find something new and unusual. Just as an amateur optical observer hopes to notice a supernova or a new comet, so does an amateur radio observer hope to notice a new radio source, or one whose radiation has changed appreciably.

### How do I get started?

Just as a long journey begins with the first step, the project you elect must start with a clear idea of your objectives. Do you wish to study the sun? Jupiter? Make meteor counts? Do you wish to engage in imaging radio astronomy? What you decide will not only determine the type of equipment you will need, but also the local radio spectrum.



The Reber Telescope at NRAO. Constructed by Grote Reber in 1937 in his back yard in Wheaton, Illinois



SARA Members discussing the IBT (Itty Bitty Telescope)

