

RADIO ASTRONOMY

Journal of the Society of Amateur Radio Astronomers
November - December 2021



SARA Member Observation Antenna Systems



Dennis Farr
SARA President

Dr. Richard A. Russel
Editor

Whitham D. Reeve
Contributing Editor

Radio Astronomy is published bimonthly as the official journal of the Society of Amateur Radio Astronomers. Duplication of uncopyrighted material for educational purposes is permitted but credit shall be given to SARA and to the specific author. Copyrighted materials may not be copied without written permission from the copyright owner.

Radio Astronomy is available for download only by SARA members from the SARA web site and may not be posted anywhere else.

It is the mission of the Society of Amateur Radio Astronomers (SARA) to: Facilitate the flow of information pertinent to the field of Radio Astronomy among our members; Promote members to mentor newcomers to our hobby and share the excitement of radio astronomy with other interested persons and organizations; Promote individual and multi station observing programs; Encourage programs that enhance the technical abilities of our members to monitor cosmic radio signals, as well as to share and analyze such signals; Encourage educational programs within SARA and educational outreach initiatives. Founded in 1981, the Society of Amateur Radio Astronomers, Inc. is a membership supported, non-profit [501(c) (3)], educational and scientific corporation.

Copyright © 2021 by the Society of Amateur Radio Astronomers, Inc. All rights reserved.

Cover Photo: Peter East, Bruce Randall, Wolfgang Herrmann

Contents

President's Page	3
Editor's Notes	4
SARA NOTES	5
News: (Nov-Dec 2021)	8
Technical Knowledge & Education: (Nov-Dec 2021)	13
For Your Radio Astronomy Bookshelf.....	15
SuperSID	16
John Cook's VLF Report	19
BAA RA Section Winter programme 2022	37
Member Comments	38
Feature Articles	40
Time Aspects of the 12 October 2021 Geomagnetic Sudden Impulse.....	40
Observation Reports	51
Pulsar Observation with a 2.3-m Dish	51
Observation of Ionospheric and Magnetic Transients on 27 November 2021	54
IBT Observation of the November 2021 Lunar Eclipse.....	56
An October 2021 Observation of Pulsar B0329+54.....	61
Membership	64
New Members	64
Journal Archives & Other Promotions.....	64
SARA Online Discussion Group	65
What is Radio Astronomy?	65
Administrative	66
Officers, directors, and additional SARA contacts.....	66
Resources	68
Great Projects to Get Started in Radio Astronomy	68
Radio Astronomy Online Resources	70
For Sale, Trade and Wanted	71
SARA Advertisements	73
SARA Brochure.....	74

Radio Waves

President's Page



It's that gift giving time of year, when we are all bombarded by questions by parents and grand parents about what telescope they should buy for their 10 year old. I'm sure you can all relate.

Tell them not to give the gift of hardware, but of knowledge. Even though SARA offers Scope In a Box, I would never recommend giving it to a person that has not had the chance to gain some knowledge of the three basic elements.

1. Astronomy
2. Telescopes
3. Radio (amateur, or HAM radio is highly recommended.)

I am currently binge watching the SciFi TV series 'Invasion' on Apple TV. A lot of focus on detecting signals from space. Mostly correct technically, as near as I can determine.

Please let me or any other board member know if you think there is anything SARA can do to enhance the radio astronomy experience for people at any and all levels of experience.

Keep your antennas pointed up!

Dennis

Editor's Notes

We are always looking for basic radio astronomy articles, radio astronomy tutorials, theoretical articles, application and construction articles, news pertinent to radio astronomy, profiles and interviews with amateur and professional radio astronomers, book reviews, puzzles (including word challenges, riddles, and crossword puzzles), anecdotes, expository on "bad astronomy," articles on radio astronomy observations, suggestions for reprint of articles from past journals, book reviews and other publications, and announcements of radio astronomy star parties, meetings, and outreach activities.

New Journal Feature – Observation Reports

We are now accepting 1-2 page observation reports. These reports should include the astronomical objects RA/DEC plus UTC of the observation. Also include the telescope configuration, process used to observe the object and results. Picture of the setup and plots of the observation are a plus to the report.

If you would like to write an article for Radio Astronomy, please follow **the newly updated Author's Guide** on the SARA web site:

http://www.radio-astronomy.org/publicat/RA-JSARA_Author's_Guide.pdf.

Let us know if you have questions; we are glad to assist authors with their articles and papers and will not hesitate to work with you. You may contact your editors any time via email here: edit@radio-astronomy.org.

The editor(s) will acknowledge that they have received your submission within two days. If they do not reply, assume they did not receive it and please try again.

Please consider submitting your radio astronomy observations for publication: any object, any wavelength. Strip charts, spectrograms, magnetograms, meteor scatter records, space radar records, photographs; examples of radio frequency interference (RFI) are also welcome.

Guidelines for submitting observations may be found here: http://www.radio-astronomy.org/publicat/RA-JSARA_Observation_Submission_Guide.pdf

Issue	Articles	Review	Distribution
2022			
Jan-Feb	Feb 12	Feb 22	Feb 28
Mar-Apr	Apr 12	Apr 22	Apr 30
May-Jun	Jun 12	Jun 22	Jun 30
Jul-Aug	Aug 12	Aug 22	Aug 31
Sept-Oct	Oct 12	Oct 22	Oct 31
Nov-Dec	Dec 12	Dec 22	Dec 31

SARA NOTES

Virtual 2022 SARA Spring Conference to be held on April 16, 2022

The 2022 SARA Spring Conference will be held on Zoom, April 16, 2022. This virtual conference will replace the annual SARA Western Conference because of the continuing COVID-19 pandemic.

Contact: Please contact conference coordinator Dave Westman if you have any questions about the conference or if you would like to help [westernconf at radioastronomy dot org](mailto:westernconf@radioastronomy.org). Website: www.radio-astronomy.org

Presentations and proceedings: Papers and presentations on radio astronomy hardware, software, education, research strategies, philosophy, and observing efforts and methods are welcome. The deadline for submitting a letter of intent to the conference coordinator including a proposed title and informal abstract or outline is 15 February 2022. Formal proceedings will be published electronically for this conference, and a link will be emailed to registered participants.

Registration: Registration for the 2022 Spring Conference is just US\$25.00. Attendees at the conference must be SARA members; if you are not yet a member, this will cost an additional \$20. Payment can be made from the SARA Store, (<https://www.radio-astronomy.org/store/> - please look for Spring Virtual Conference), or payment can be made by going to www.paypal.com and directing payment to [treas at radio-astronomy dot org](mailto:treas@radio-astronomy.org). Please include in comments that the payment is for the 2022 Spring Conference. You also can mail a check to SARA Treasurer (Brian O'Rourke), 337 Meadow Ridge Rd, Troy, VA. 22974 . Please include an e-mail address so a confirmation can be sent to you upon receipt of payment.

Call for papers: 2022 SARA Spring Conference Virtual on Zoom

The Society of Amateur Radio Astronomers (SARA) hereby solicits papers for presentation at its 2022 Spring Conference, to be held April 16, 2022 via Zoom. Papers on radio astronomy hardware, software, education, research strategies, observations and philosophy are welcome. SARA members or supporters wishing to present a paper should email a letter of intent, including a proposed title and informal abstract or outline to [westernconf at radio-astronomy dot org](mailto:westernconf@radio-astronomy.org) no later than 15 February 2022 (please let us know if you require more time). Be sure to include your full name, affiliation, postal address, and email address, and indicate your willingness to participate in the conference to present your paper. Submitters will receive an email response, typically within one week. Formal printed Proceedings will be published electronically for this conference and a link will be sent to each participant prior to the conference. Website: www.radio-astronomy.org



Dr. Darcy Barron
Keynote Speaker
SARA 2022 Spring Conference

I am pleased to announce that Dr. Darcy Barron, Assistant Professor, Dept. of Physics and Astronomy, University of New Mexico, has agreed to give the keynote speech at the 2022 SARA Spring Conference on April 16, 2022. Prior to joining the department at UNM, Dr. Barron was a National Science Foundation Astronomy and Astrophysics Postdoctoral Fellow and Charles H. Townes Postdoctoral Fellow at the Space Sciences Lab at University of California, Berkeley. Dr. Barron received her PhD in Physics from the University of California, San Diego in 2015, advised by Prof. Brian Keating.

An active member of the international POLARBEAR, Simons Observatory, and CMB-S4 collaborations, Dr. Barron is passionate about cosmology and instrumentation. Her current research focuses on precision measurements of the cosmic microwave background (CMB), including building instruments to study the faint divergence-free polarization pattern known as B-mode polarization. Detailed characterization of the CMB will further our understanding of the components of the universe and its large-scale structure.

When she's not working, she can be found exploring the deserts and mountains of New Mexico by foot, bicycle, and plane. She also appreciates the longer wavelengths of the electromagnetic spectrum and is a licensed amateur radio operator.

Honors

Women in STEM award from ADVANCE at UNM, 2019

NSF Astronomy and Astrophysics Postdoctoral Fellow, 2015 - 2018

Charles H. Townes Fellow at Space Sciences Laboratory, UC Berkeley, 2015-2018

Second inductee to Spring Valley C.C.S.D. Foundation Honors Hall of Fame, 2020

SARA Student & Teacher Grant Program

All, SARA has a grant program that is, sad to say very underutilized. We will provide kits or money to students and teachers including college students to help them with a radio telescope project. SARA can supply any of the following kits:

- SuperSID
- Scope in a Box
- IBT (Itty Bitty Telescope)
- Radio Jove kit
- Inspire
- Sky Scan

We can also provide up to five hundred dollars (\$500.00 USD) for an approved radio telescope project.

We have on occasion provided more money based on the merits of the project and the SARA Grant Committee approval.

More information on the grant program can be found at the URL below.

[SARA Student and Teacher Project Grants | Society of Amateur Radio Astronomers \(radio-astronomy.org\)](https://www.radio-astronomy.org/SARA-Student-and-Teacher-Project-Grants)

All that is required is the SARA grant request form be filled out and sent in. If it needs more work for approval, we will work with the student to help ensure their success.

Please pass the word that SARA will fund any legitimate radio telescope project anywhere in the world.

If you have a question, contact me at [crowleytj at hotmail](mailto:crowleytj@hotmail.com) dot com.

Tom Crowley
SARA Grant Program Administrator

Drake's Lounge

Join the SARA community as we discuss the latest astronomy and radio astronomy news. The lounge also provides a forum to share and get advice on your radio astronomy projects from very experienced amateur radio astronomers.

Drake's Lounge is every month on the 3rd Sunday at 2 pm Eastern time. ZOOM email notifications will be sent to all members.

See you there!

News: (Nov-Dec 2021)



Manuscripts are solicited for a special issue of *Advances in Space Research* (ASR) entitled *Recent Progress in the Physics of the Sun and Heliosphere*.

The main objective of this special issue is to highlight and review recent progress achieved in different areas of Solar Physics. While we expect many contributions from participants of the 16th European Solar Physics Meeting (ESPM-16, <https://indico.ict.inaf.it/event/794/>) organized in September 2021, we welcome original and high-quality relevant manuscripts from all scientists working on solar and heliospheric physics. All submissions must be original papers that meet the quality and peer-review standards of *Advances in Space Research*.

Papers must be submitted electronically to <https://www.editorialmanager.com/AISR>. To ensure that all manuscripts are correctly identified for inclusion into the special issue, authors must select "Special Issue: Progress in solar physics" when they reach the "Article Type" step in the submission process (see attached file).

Submission portal opens: November 8, 2021, Submission portal closes: April 1, 2022

Machine Learning in Heliophysics

21-25 March 2022, Boulder (CO), USA and virtual!

Topics:

Space weather forecasting
Inverse problems
Automatic event identification
Feature detection and tracking
Surrogate models
Uncertainty Quantification

Methods:

Machine and Deep Learning
System identification
Information theory
Combination of physics-based and data-driven modeling
Bayesian analysis

The goal of the ML- Helio conference is to leverage the advancements happening in disciplines such as machine learning, deep learning, statistical analysis, system identification, and information theory, in order to address long-standing questions and enable a higher scientific return on the wealth of available heliospheric data.

We aim at bringing together a cross-disciplinary research community: physicists in solar, heliospheric, magnetospheric, and aeronomy fields as well as computer and data scientists. ML- Helio will focus on the development of data science techniques needed to tackle fundamental problems in space weather forecasting, inverse estimation of physical parameters, automatic event identification, feature detection and tracking, times series analysis of dynamical systems, combination of physics-based models with machine learning techniques, surrogate models and uncertainty quantification.

The conference will consist of classic-style lectures, complemented by hands-on tutorials on Python tools and data resources available to the heliophysics machine learning community.

Deadline for abstracts: January 15th, 2022. The conference will be hosted in hybrid mode (in-person and virtual). For more information: <https://ml-helio.github.io/>

We expect all the participants of Machine Learning in Heliophysics to follow our [Code of Conduct](#).

COVID update: We currently expect that only fully vaccinated people (as defined by [CDC guidelines](#)) will be allowed to attend the conference in person. This guidance might change, and we will continue to follow the CDC and state of Colorado recommendations.

NASA HQ Citizen Science Announcements

From: Elizabeth MacDonald, Abigail Rymer (abigail.m.rymer at nasa.gov)

The Heliophysics Citizen Science Strategic Working Group of NASA HQ: <https://science.nasa.gov/heliophysics/programs/citizen-science> announces the following upcoming opportunities for the SPA community. For more information on any of these, please contact Liz MacDonald, elizabeth.a.macdonald@nasa.gov.

1) Are you interested in starting a citizen science project? In ROSES-2021 Appendix F.9, the 2nd offering of the Citizen Science Seed Funding Program (CSSFP) proposals are due 21 Jan 2022?

(<https://science.nasa.gov/researchers/solicitations/roses-2021/amendment-41-citizen-science-seed-funding-program-revised-text-and-new-due-dates>)

2) The NASA Established Program to Stimulate Competitive Research (EPSCoR) Rapid Response Research (R3) solicitation from the GSFC Computational and Information Sciences and Technology Office will be an opportunity to partner and broaden participation in the area of data science and existing Heliophysics citizen science. A new FY22 solicitation is anticipated to be released in December. For more information, see

<https://www.nasa.gov/stem/epscor/rapid/index.html>

3) Lastly, we have recently developed a Citizen Science for Scientists Roadshow presentation to provide professional scientists with examples, inspiration and direction to add a Citizen Science element to their work. If you would like to request a presentation from the Citizen Science Roadshow team for your institution, please contact: Mike Cook, michael.r.cook@nasa.gov?

The 3rd URSI Atlantic Radio Science Meeting (AT-AP-RASC 2022) will be held in Gran Canaria (hybrid format) in 2022 May 29 – June 3 (<https://www.atrasc.com/>).

Deadline for abstract submission is 15th January 2022 (see <https://www.atrasc.com/callforpapers.php>).

There are a number of sessions related to radio astronomy that you may be interested in:

J01: New Telescopes

J02: VLBI

J03: Time-domain astronomy - observations and instrumentation

J04: Cosmological HI - observations and instrumentation

J05: Wide-field radio astronomy

J06: Space-based radio astronomy

J07: Calibration and instrumentation

J08: CEM method for radio astronomy

J09: Receiving systems and their components

J10: Big Data and AI in radio interferometry

J11: Latest new and observatory reports (open session)

JE: EMC issues in integration of digital and analog electronics

JG: Mutual Benefit between radio astronomy and ionospheric science

JH: Solar, heliospheric and planetary physics

Please take a look at the attached information on the different sessions being run under Commission J (Radio Astronomy) and consider submitting an abstract for the conference.

Fast Radio Burst U-TUBE Video recommended by Sandy Weinreb



[Fast Radio Bursts - Liam Connor - 12/10/2021 - YouTube](#)

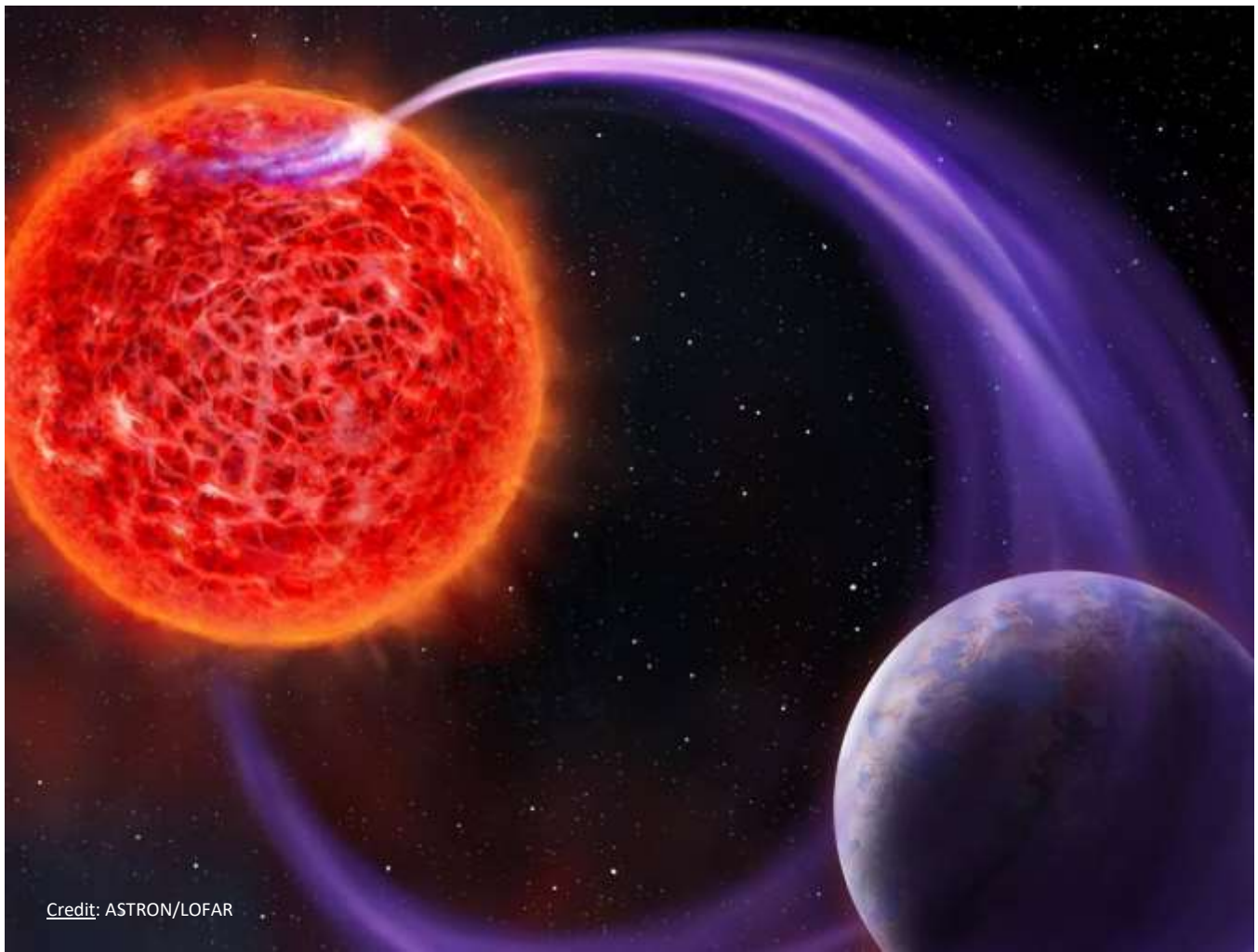

Credit: ASTRON/LOFAR

Universe Today ~ *LOFAR Sees Strange Radio Signals Hinting at Hidden Exoplanets:*

<https://www.universetoday.com/152901/lofar-sees-strange-radio-signals-hinting-at-hidden-exoplanets/>

Hey, Mac, what the ...? Universe Today ~ *China's FAST Telescope Could Detect Self-Replicating Alien Probes:*

<https://www.universetoday.com/152936/chinas-fast-telescope-could-detect-self-replicating-alien-probes/>

EurekaAlert ~ *Over a thousand cosmic explosions in 47 days detected by FAST:* <https://www.eurekaalert.org/news-releases/931451>

The University of Sydney ~ *Strange radio waves emerge from direction of the galactic centre:* <https://www.sydney.edu.au/news-opinion/news/2021/10/12/strange-radiowaves-galactic-centre-askap-j173608-2-321635.html>



Phys.org ~ *Radio signals from distant stars suggest hidden planets:* <https://phys.org/news/2021-10-radio-distant-stars-hidden-planets.html>

Spaceweather.com ~ *20 Years Ago, A Severe Geomagnetic Storm:*

<https://spaceweather.com/archive.php?view=1&day=21&month=10&year=2021>



Hey, Mac, I guess what you've been sayin' all along is official now, again: Universe Today ~ *The Radio Signal From Proxima Centauri Came From Earth After All:*

<https://www.universetoday.com/153097/the-radio-signal-from-proxima-centauri-came-from-earth-after-all/>

Universe Today ~ *Researchers Use Ancient Literature to Track 3,000 Years of Auroras:*
<https://www.universetoday.com/153089/researchers-use-ancient-literature-to-track-3000-years-of-auroras/>



HamSci.org ~ *HamSCI's WWV/H Scientific Modulation Working Group is exploring possibilities for additions to WWV and WWVH's modulation that can be used for science purposes:*
<https://www.hamsci.org/wwv>

National Research Foundation, South African Radio Astronomy Observatory ~ *Large MeerKAT data release reveals beautiful new cosmic puzzles:*
<https://www.sarao.ac.za/media-releases/large-meerkat-data-release-reveals-beautiful-new-cosmic-puzzles/>



Ig® Nobel Prize Winners ~ *For achievements that first make people LAUGH then make them THINK:*
<https://www.improbable.com/2021-ceremony/winners/>



Universe Today ~

- ⚙ *The Next Generation Very Large Array Would be 263 Radio Telescopes Spread Across North America:*
<https://www.universetoday.com/153323/the-next-generation-very-large-array-would-be-263-radio-telescopes-spread-across-north-america/>
- ⚙ *Universe Today ~ Astronomy Jargon 101: Cosmic Microwave Background:*
<https://www.universetoday.com/153272/astronomy-jargon-101-cosmic-microwave-background/>

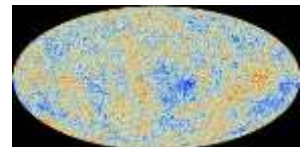

Technical Knowledge & Education: (Nov-Dec 2021)

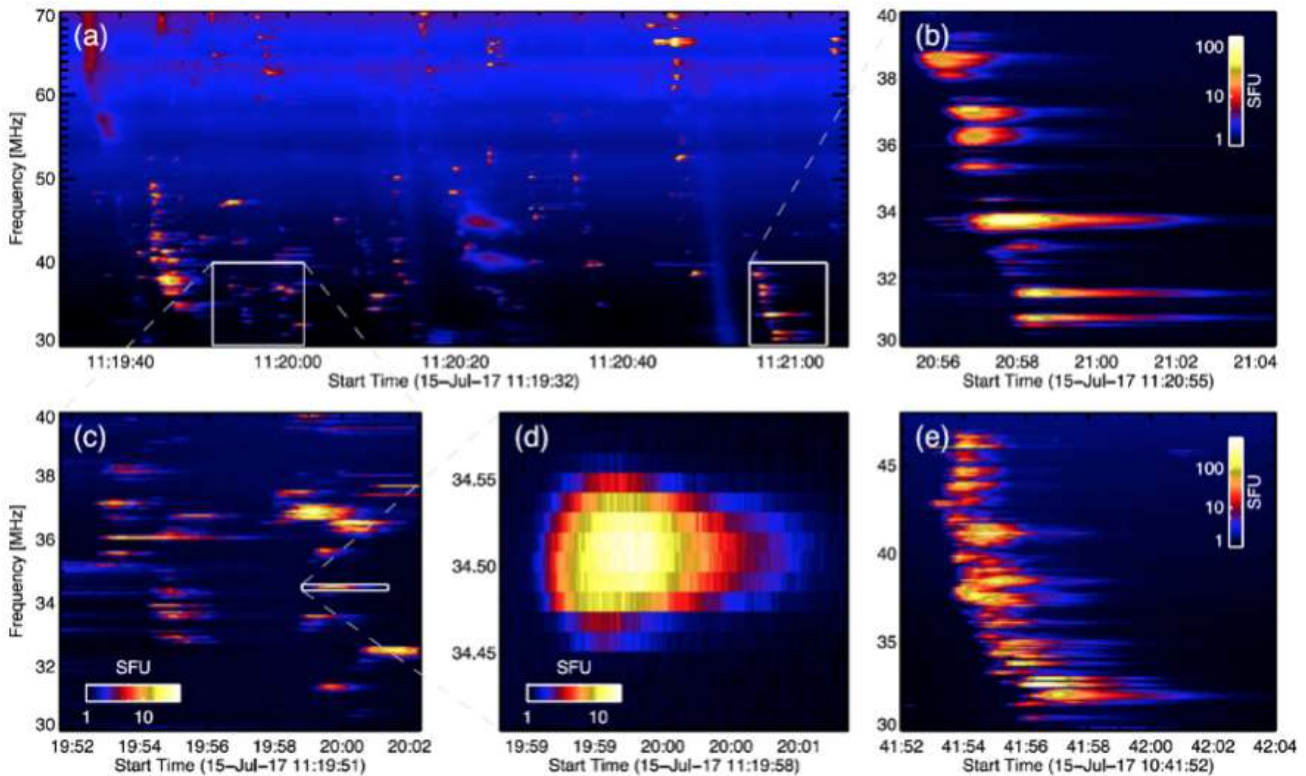

Community of European Solar Radio Astronomers (CESRA) ~ *First Frequency-time-resolved Imaging Spectroscopy Observations of Solar Radio Spikes*: <https://www.astro.gla.ac.uk/users/eduard/cesra/?p=3080>

Rigol ~

- ⚙ *Advanced Measurements with a VNA*: <https://www.rigolna.com/vna-app-note/>
- ⚙ *RIGOL Classroom Solutions*: <https://www.rigolna.com/education/>

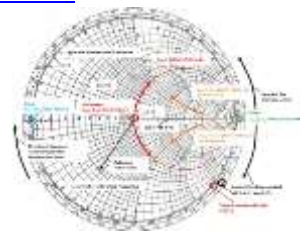

Research Notes of the AAS (RNAAS) ~ *The Widefield Arecibo Virgo Extragalactic Survey: Early Results on Known Dark Sources*: <https://iopscience.iop.org/article/10.3847/2515-5172/ac29c7>

NRAO ~ *Making of the 140ft Radio Telescope (at Green Bank)*: <https://www.youtube.com/watch?v=9idOe-ITRys>



SKA ~ *Advancing Astrophysics with the Square Kilometre Array*:

- ⚙ *Volume 1*: <https://www.skatelescope.org/wp-content/uploads/2011/03/SKA-Astrophysics-Vol1.pdf>
- ⚙ *Volume 2*: <https://www.skatelescope.org/wp-content/uploads/2011/03/SKA-Astrophysics-Vol2.pdf>

Community of European Solar Radio Astronomers (CESRA) ~ *Radio, X-ray and extreme-ultraviolet observations of weak energy releases in the 'quiet' Sun*: <https://www.astro.gla.ac.uk/users/eduard/cesra/?p=3090>

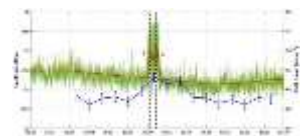

arXiv ~ *Comparative Analysis of the Observational Properties of Fast Radio Bursts at the Frequencies of 111 and 1400 MHz*: <https://arxiv.org/abs/2109.11881>

With Fraser Cain ~ *Using Pulsars to Detect Gravitational Waves: with Boris Goncharov*:
<https://www.youtube.com/watch?v=eF3wt8obkD0>

NRAO ~ *Next Generation Very Large Array Strongly Endorsed by Decadal Survey*:
<https://public.nrao.edu/news/ngvla-strongly-endorsed-by-decadal-survey/>



NRAO ~ *Invisible Colors: Why Astronomers Use Different Radio Bands*:
<https://public.nrao.edu/news/invisible-colors-why-astronomers-use-different-radio-bands/>

Signal Integrity Journal ~ *How Not to be Confused by S-Parameters*:
<https://www.signalintegrityjournal.com/articles/1663-how-not-to-be-confused-by-s-parameters>



Community of European Solar Radio Astronomers (CESRA) ~ *Radio Interferometric Observations of the Sun Using Commercial Dish TV Antennas*:
<https://www.astro.gla.ac.uk/users/eduard/cesra/?p=3100>



Youtube ~ *Pablo Lewin WA6RSV Building your first fully functioning Hydrogen Line Radio Telescope*: <https://www.youtube.com/watch?v=hiZZsTXNufo>

ElectronicDesign.com ~ *How to Easily Design Power Supplies*:

- ⚙ <https://www.electronicdesign.com/power-management/whitepaper/21172208/analog-devices-how-to-easily-design-power-supplies-part-1>
- ⚙ <https://www.electronicdesign.com/power-management/whitepaper/21173567/analog-devices-how-to-easily-design-power-supplies-part-2>
- ⚙ <https://www.electronicdesign.com/power-management/whitepaper/21174736/analog-devices-how-to-easily-design-power-supplies-part-3>



Signal Integrity Journal ~

- ⚙ *A Guide for Single-Ended to Mixed-Mode S-parameter Conversions*:
<https://www.signalintegrityjournal.com/articles/1832-a-guide-for-singleended-to-mixedmode-s-parameter-conversions>
- ⚙ *EMC Fundamentals: Pre-compliance Testing Using a Real-time Oscilloscope*:
<https://www.signalintegrityjournal.com/articles/2320-emc-fundamentals-pre-compliance-testing-using-a-real-time-oscilloscope>

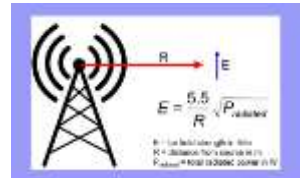

Cornell University, arXiv.org ~ *Search for fast radio transients using Arecibo drift-scan observations at 1.4 GHz*:
<https://arxiv.org/abs/2110.14698>

Rohde & Schwarz ~ *Receiver Testing: Why test signal quality matters*:
https://www.rohde-schwarz.com/us/campaigns/rsa/icr/receiver-testing-why-test-signal-quality-matters_255085.html



InCompliance magazine ~ *Application of Thrifty Test Equipment for EMC Testing, Low-Cost Instruments and Procedures to Troubleshoot EMC Issues*: <https://incompliancemag.com/article/application-of-thrifty-test-equipment-for-emc-testing/>

Meteor News ~ A global network for radio meteor observers:
<https://www.meteornews.net/2021/12/04/a-global-network-for-radio-meteor-observers/>



For Your Radio Astronomy Bookshelf

(Prices in USD)

Radio Spectrum Management: Policies, Regulations and Techniques, Mazar, Haim; 2016, \$97

RF Spectrum Management: An introduction to the Radio Frequency Spectrum Management at National and International Levels 2nd Edition, Cruz-Pol, Sandra; 2019 \$77



SuperSID
*Collaboration of Society
of Amateur Radio
Astronomers and
Stanford Solar Center*



- ✓ Stanford provides data hosting, database programming, and maintains the SuperSID website
- ✓ Society of Amateur Radio Astronomers (SARA) sells the SuperSID monitors for 48 USD to amateur radio astronomers and the funds are then used to support free distribution to students all over the world (image below as of Fall 2017)
- ✓
- ✓ Jonathan Pettingale at SARA is responsible for building and shipping the SuperSID monitor kits: SuperSID@radio-astronomy.org
- ✓ SuperSID kits may be ordered through the SARA SuperSID webpage: <http://radio-astronomy.org/node/210>
- ✓ Questions about the SuperSID project may be directed to Steve Berl at Stanford: steveberl@gmail.com
- ✓ Jaap Akkerhuis at Stanford is responsible for the SuperSID software and SARA has provided financial support for his efforts
- ✓ SuperSID website hosted by Stanford: <http://solar-center.stanford.edu/SID/sidmonitor/>
- ✓ SuperSID database: <http://sid.stanford.edu/database-browser/>
- ✓ The data is searchable by time, station, date, and multiple plots may be placed on the same graph for comparison.



For official use only
 Monitor assigned: _____
 Site name: _____
 Country: _____

SuperSID Space Weather Monitor Request Form

	<i>Your information here</i>		
Name of site/school (if an institution):			
Choose a site name: (3-6 characters) No Spaces			
Primary contact person:			
Email:			
Phone(s):			
Primary Address:	Name School or Business Street Street City Country	State/Province Postal Code	
Shipping address, if different:	Name School or Business Street Street City Country	State/Province Postal Code	
Shipping phone number:			
Latitude & longitude of site:	Latitude: _____ Longitude: _____		

I understand that neither Stanford nor the Society of Amateur Radio Astronomers is responsible for accidents or injuries related to monitor use. I will assure that a surge protector and other lightning protection devices are installed if necessary.

Signature: _____ **Date:** _____

I will need:

<i>What</i>	<i>Cost</i>	<i>How many?</i>
SuperSID distribution USB Power	\$48 (assembled)	
USB Sound card 96 kHz sample rate (or provide this yourself)	\$40 (optional)	
Antenna wire (120 meters) (or you can provide this yourself)	\$23 (optional) with connectors attached and tested	
RG 58 Coax Cable (9 meters) (or provide this yourself)	\$14 (optional) with connectors attached and tested	
Shipping	US \$12 Canada & Mexico \$40 all other \$60	
	TOTAL	\$

_____ I have included a \$_____ check (payable to SARA)

_____ I will make payment thru www.paypal.com to treas@radio-astronomy.org

or

_____ If you are a Minority-serving institution, in a Developing or economically deprived nation, and/or you are using the monitor with students for educational purposes, you may qualify for obtaining a monitor at reduced or no cost. Check here if you wish to apply for this designation. Then tell us how you want to use the SuperSID monitor. Include type of site, number of students involved, whether public or private school, grade levels, etc. and describe your program. The goal of the SuperSID project is to provide as many students with systems as possible. If you are able to pay for a system, even if you qualify for a free one, please do so and help support our goal.

For more details on the Space Weather Monitor project, see: <http://sid.stanford.edu>

To set up a SuperSID monitor you will need:

1. Access to power and an antenna location that is relatively free of electric interference (could be indoors or out)
2. A **PC**** with the following minimal specifications:
 - A sound card that can record (sample) up to 96 kHz, or a USB port to connect such a sound card (for North and South America)
 - All other countries can use AC97 sound card with 48 kHz record (sample) rate. Most computers made after 1997 will have AC97.
 - Windows 2000 or more recent operating system
 - 1 GHz Processor with 128 mb RAM
 - Ethernet connection & internet browser (desirable, but not required)
 - Standard keyboard, mouse, monitor, etc.
3. An inexpensive antenna that you build yourself. You'll need about 120 meters (400 feet) of **insulated** wire. Solid wire is easier to wind than stranded. Magnet wire will work but be more fragile. You can use anything from #18 to #26 size wire. The antenna frame can be made of wood, PVC pipe, or similar materials. We'll provide instructions. You can purchase the wire from us or obtain your own.
4. RG58 coax cable with a BNC connector at one end to run from the antenna to the SuperSID receiver. 9 meters is recommended, but the length will depend on where you place the antenna. You can purchase the coax from us or obtain your own.
5. Surge protector and other protection against a lightning strike

Return this form to: SuperSID@radio-astronomy.org

or mail to: SARA
Brian O'Rourke, SARA Treasurer
337 Meadow Ridge Rd,
Troy, VA 22974-3256



The British Astronomical Association

A company limited by guarantee

Registered Charity No. 210769

Burlington House, Piccadilly, London, W1J 0DU

Telephone: 020 7734 4145

Fax No.: 020 7439 4629

Email: office@britastro.org

Website: www.britastro.org



Please send all reports and observations to jacook@jacook.plus.com

John Cook's VLF Report

BAA Radio Astronomy Section

2021 SEPTEMBER

The SID count in September was only half of that recorded in August, but it did include two M-class flares. The stronger of these, at M2.8, was rather early in the morning for northern-European observers, but it was recorded by Roberto Battaiola in Milan. The M1.8 flare was later in the afternoon and widely recorded. Mark Prescott made this recording:

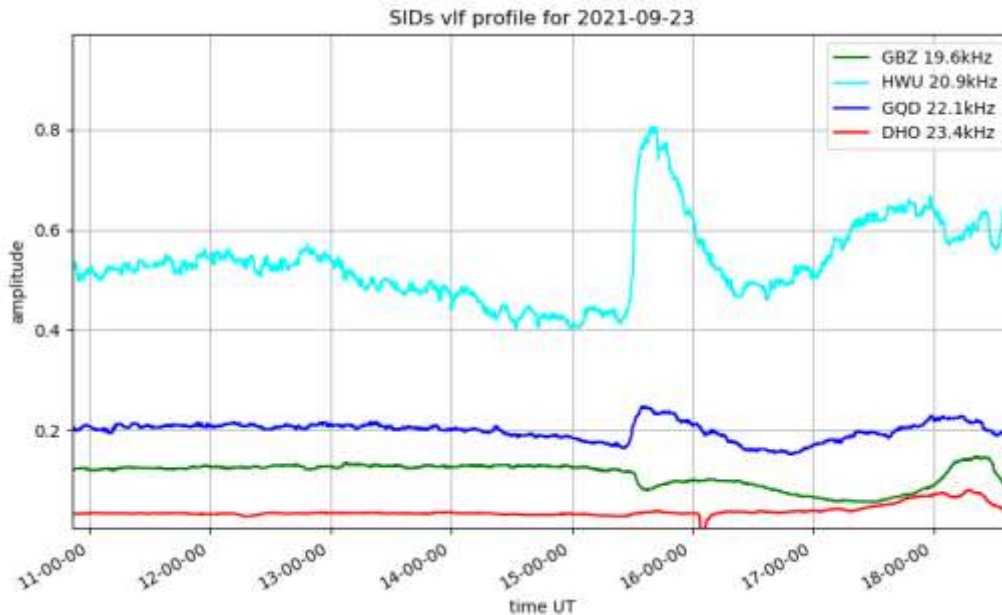

The response at 20.9 kHz is very strong, with smaller SIDs at 19.6 and 22.1 kHz. 23.4 kHz shows a very small response, barely recognisable as a SID. It is followed by a short break in the signal just after 16:00 UT. My own recordings gave a very similar response. The active region responsible for these flares was AR12871, close to the central meridian at the time. It appears to have been a reappearance of AR12860, responsible for the M4.7 flare on August 28th. These were the strongest flares of the month, among mostly small C-class and B-class events.

Some strong VHF activity was also recorded on the 23rd, some related to the M1.8 flare, and some occurring before hand. Colin Clements made recordings at 151, 408 and 610 MHz, and Colin Briden made a 28 MHz recording:

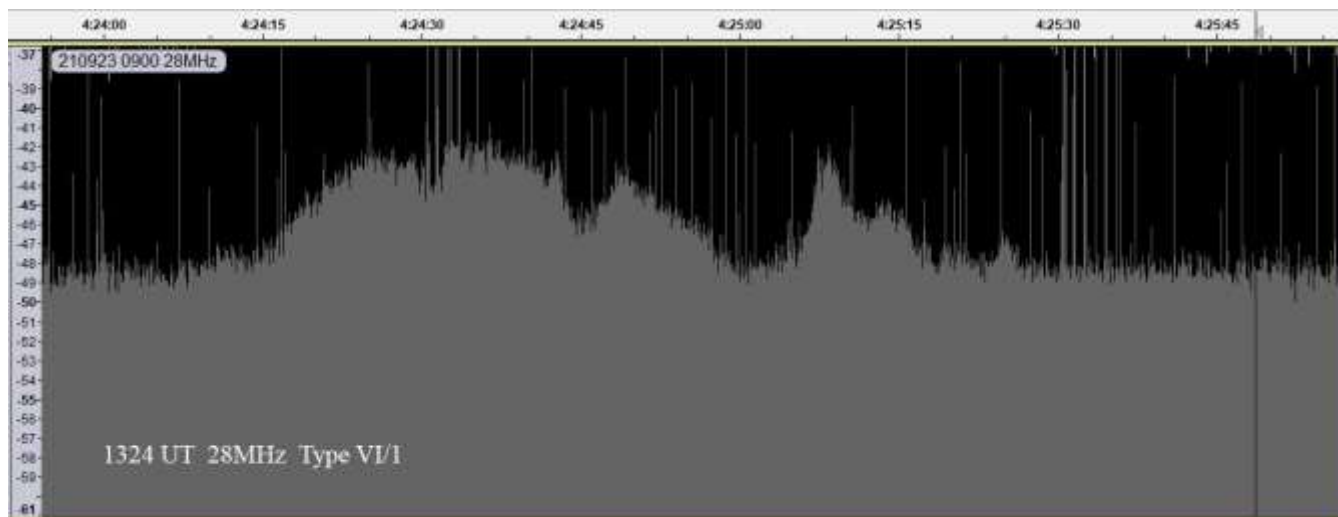
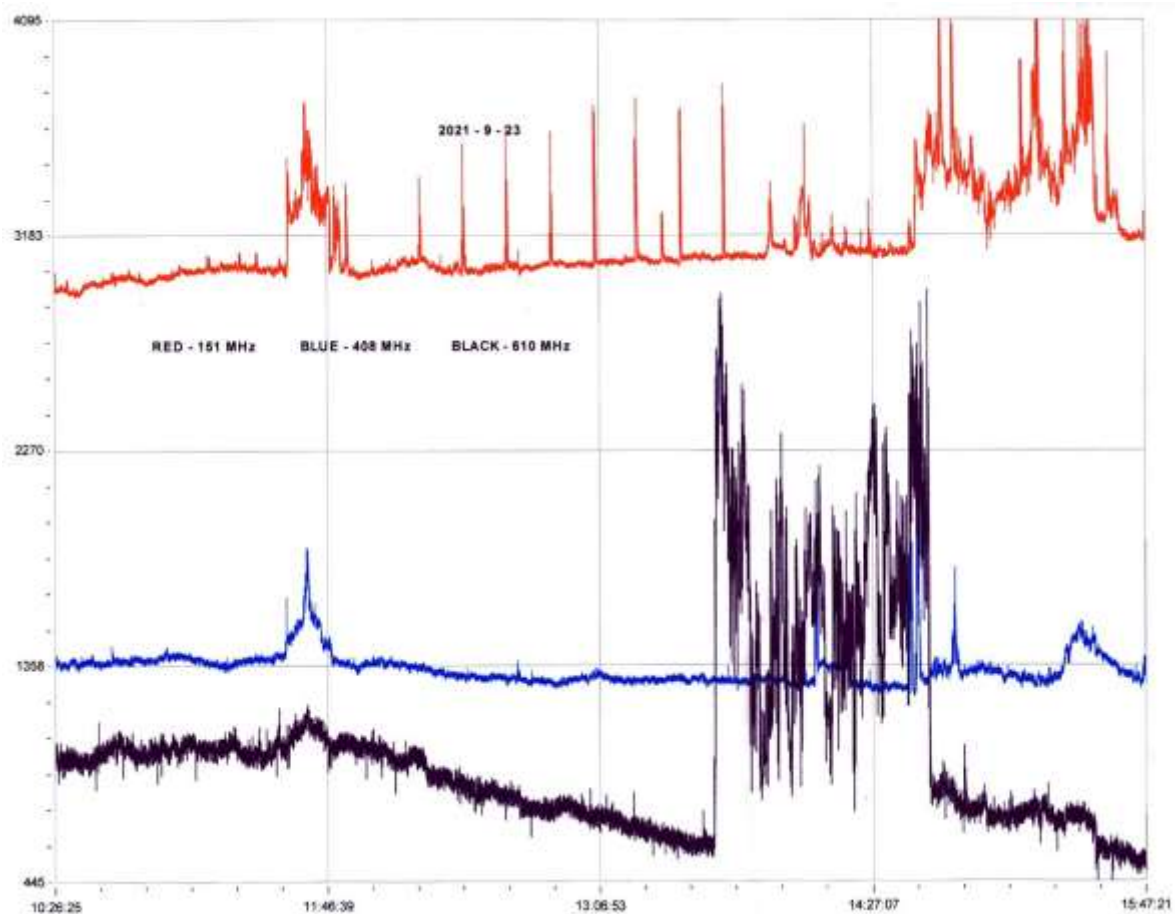

The 28 MHz signal shows a type VI/1 signal, starting at 13:24 UT, lasting for just over a minute. The type VI/1 designation implies multiple type III emissions in succession, of a small amplitude. The grey area in the chart is the time-averaged signal, varying over about 7 dB. The black area shows the signal peaks, but they are mostly off the top of the chart, and so not visible.

Colin Clements' 151 MHz signal (red) shows some local interference during the middle of the day, but has a clear burst from 14:40 to 15:50 UT, covering the period of the flare. The 610 MHz signal (black) lasts for a similar

length of time, but starting at 13:40. The blue trace shows 408 MHz, with only a very small signal overlapping that at 610 MHz. All three show a small burst around 11:30 to 11:50.

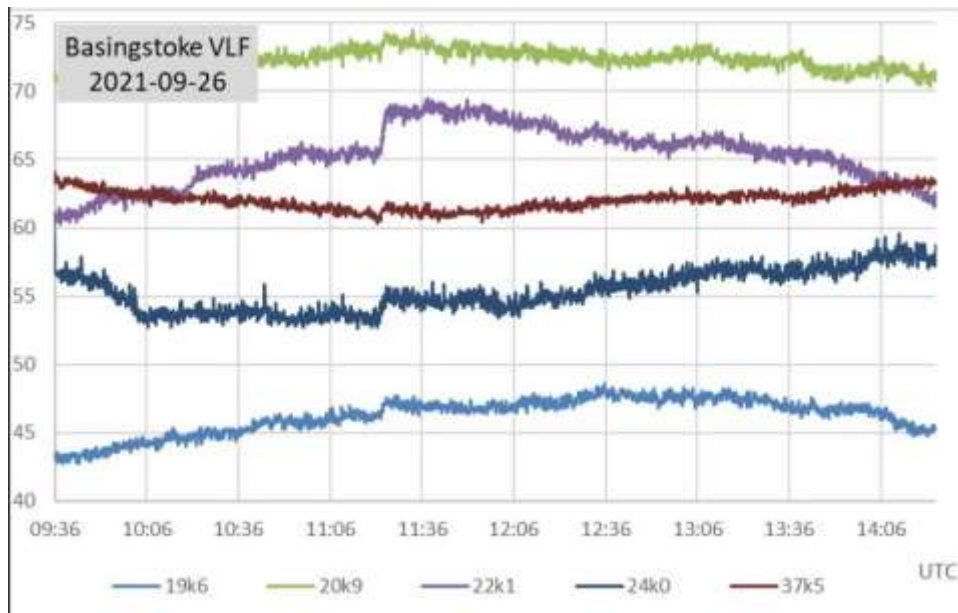

This recording from Paul Hyde shows the small C1.6 flare, peaking at 11:25 UT on the 26th. 22.1 kHz shows a very distinct SID, while 20.9 and 19.6 kHz are much weaker. Considering that the paths at 19.6 and 22.1 kHz are very close, the difference is quite surprising.

MAGNETIC OBSERVATIONS

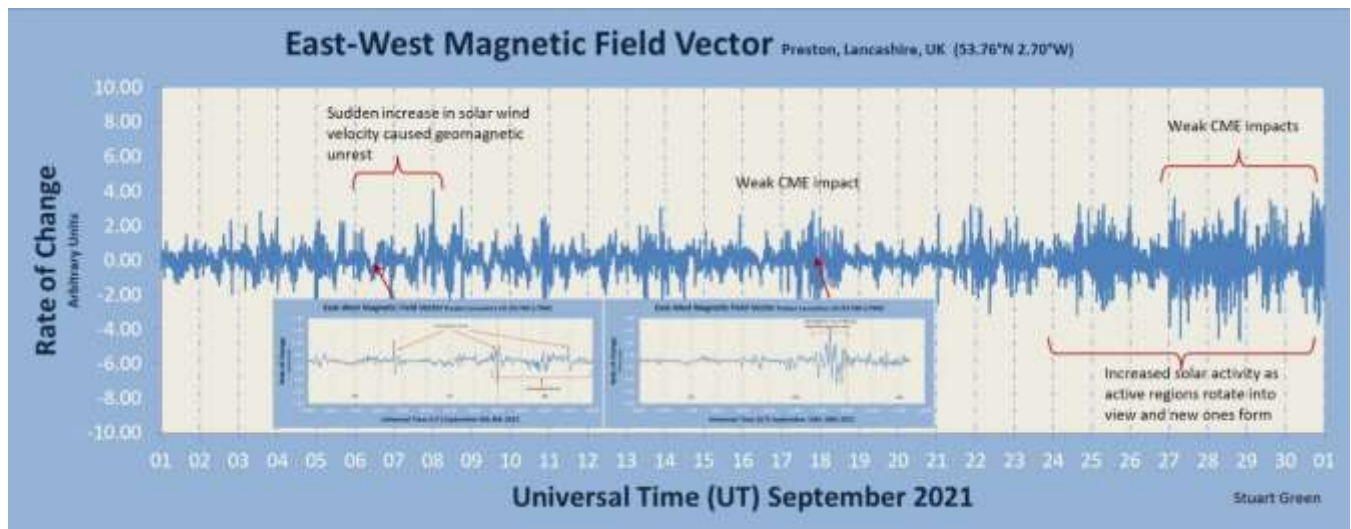

Stuart Green’s summary of the month’s activity shows a fairly quiet start, increasing in the last week. The mild disturbance over the 7th and 8th was from a coronal hole high speed wind, with some short transients shown in the inset chart on the 6th, 7th, and 8th. There were also a number of small CMEs shown in satellite images, the first of which arrived on the 17th. The chart on the next page by Paul Hearn shows the disturbance building through the day, although there is no clear sign of a CME arrival impact. Activity faded out in the early hours of the 18th.

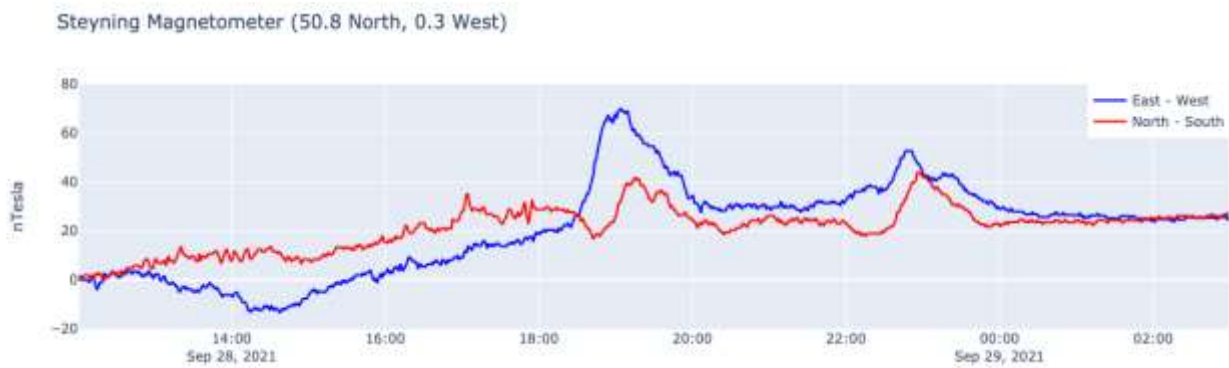
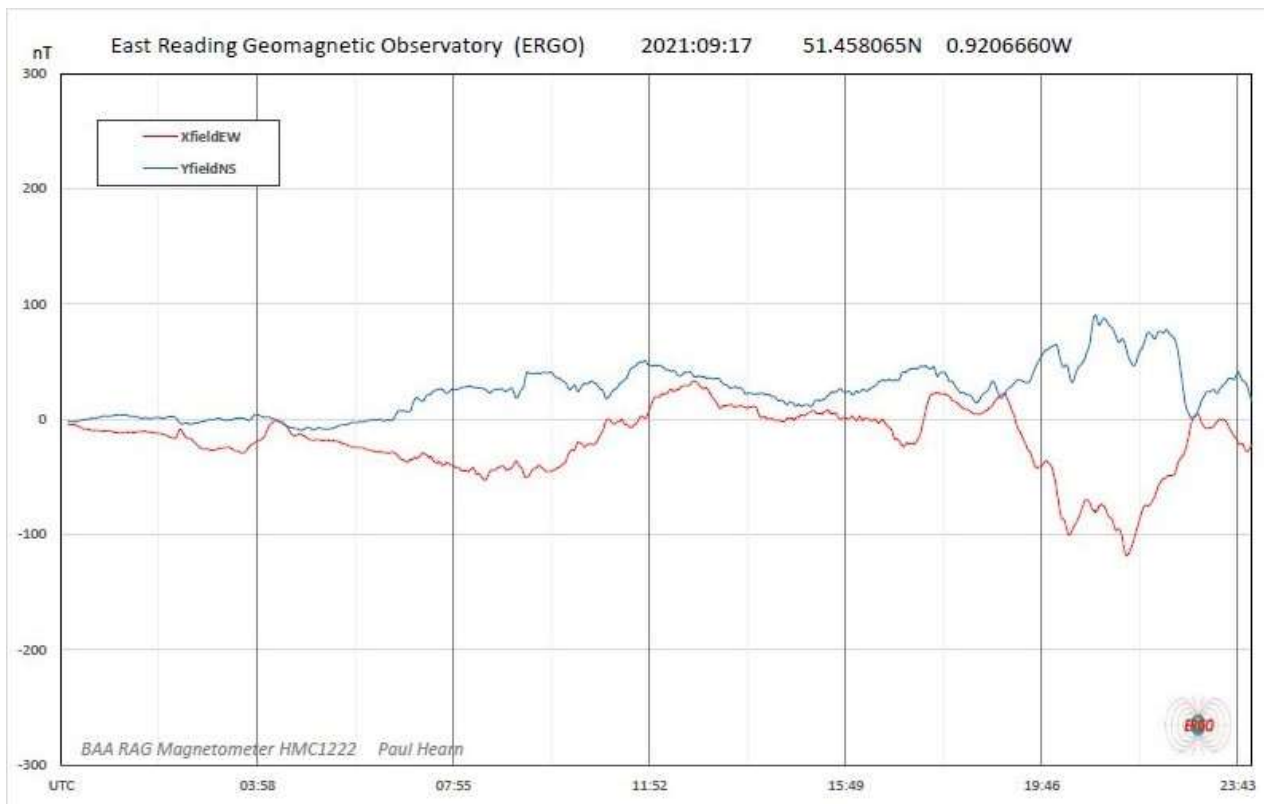

This chart from Nick Quinn shows activity from another CME on the 28th and 29th. Activity was again fairly mild, and continued into the evening of the 30th, shown in the chart from Roger Blackwell:

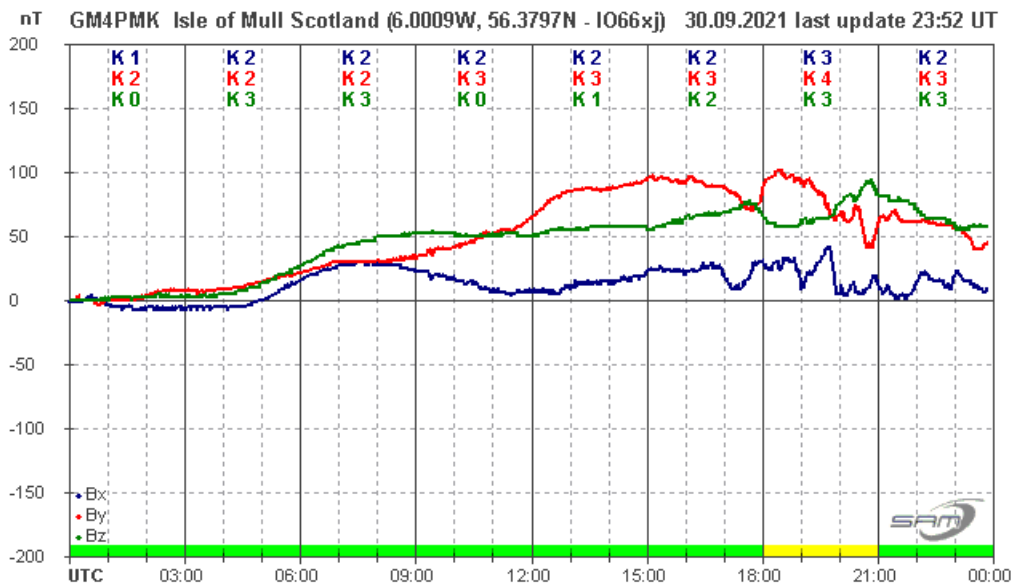

Mark Edwards recorded a 37.5 kHz transient that appeared to be from a magnetic disturbance on the 21st:

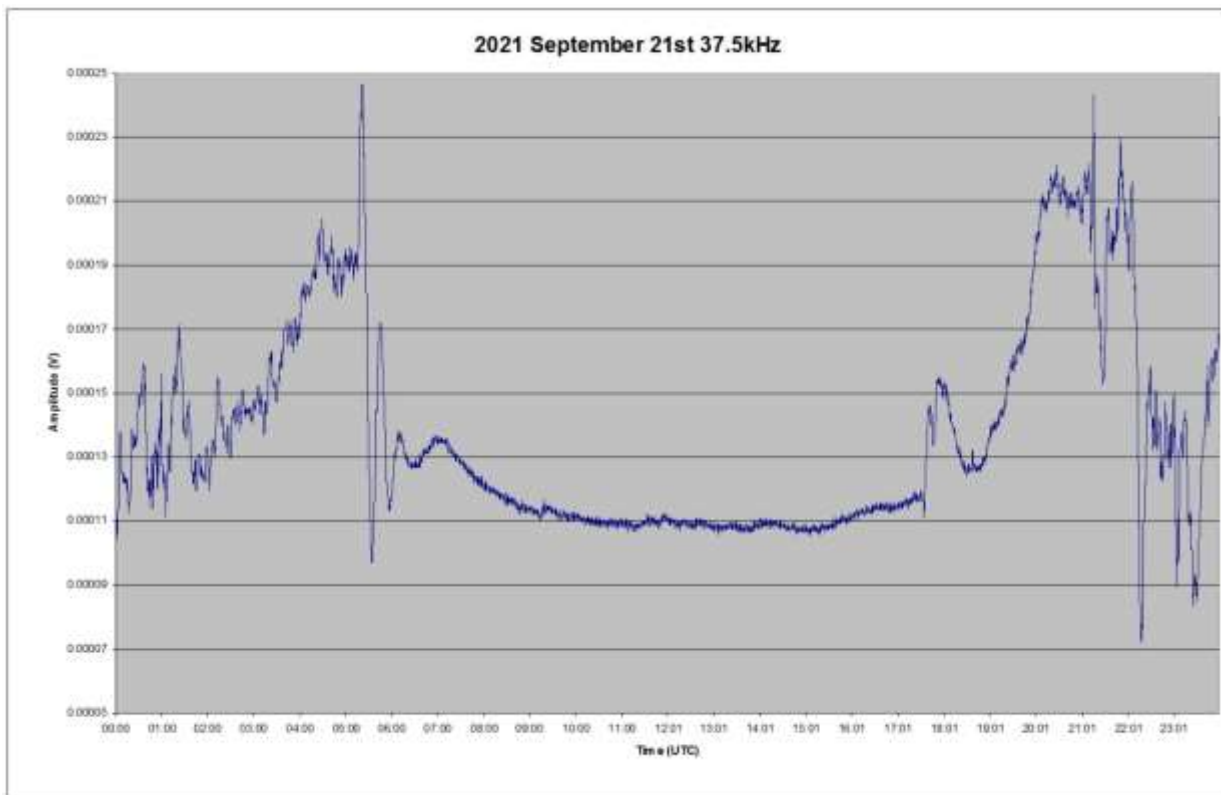

The disturbance can be seen from 17:30 to 18:30 UT, well before sunset takes over. Our own magnetic recordings do not show any significant activity at this time, although those from different parts of the world do show a strong disturbance. Those in the Americas seem to have been strongly disturbed, as well as in the Southern hemisphere.

Magnetic observations received from Roger Blackwell, Colin Clements, Stuart Green, Paul Hearn, Nick Quinn and John Cook.

MUON DETECTION

This is not a subject that we have covered previously, but David Farn has been experimenting with muon detection and has some interesting observations. His detector is based on plates of 5 STS-5 Geiger tubes, connected such that they don't cross-couple. The outputs are logged into memory so that counts can be made over time. The detector is mounted indoors, with a log of temperature and pressure being made to help avoid any local effects. It has been operating since 2020 April, and appears to be free from local interference.

The first chart shows counts in 2021 January. There is a low continuous background, with a sudden burst of activity on the 22nd. The second chart shows the detail of this activity, with two distinct peaks shown. They last for about 10 minutes, starting about 20:56UT. The cause is currently unknown, but monitoring is continuing. The third chart shows counts in August in more detail, with atmospheric pressure added. There are no 'super events' as in January, but just a small variation in background level. There appears to be no influence from atmospheric pressure.

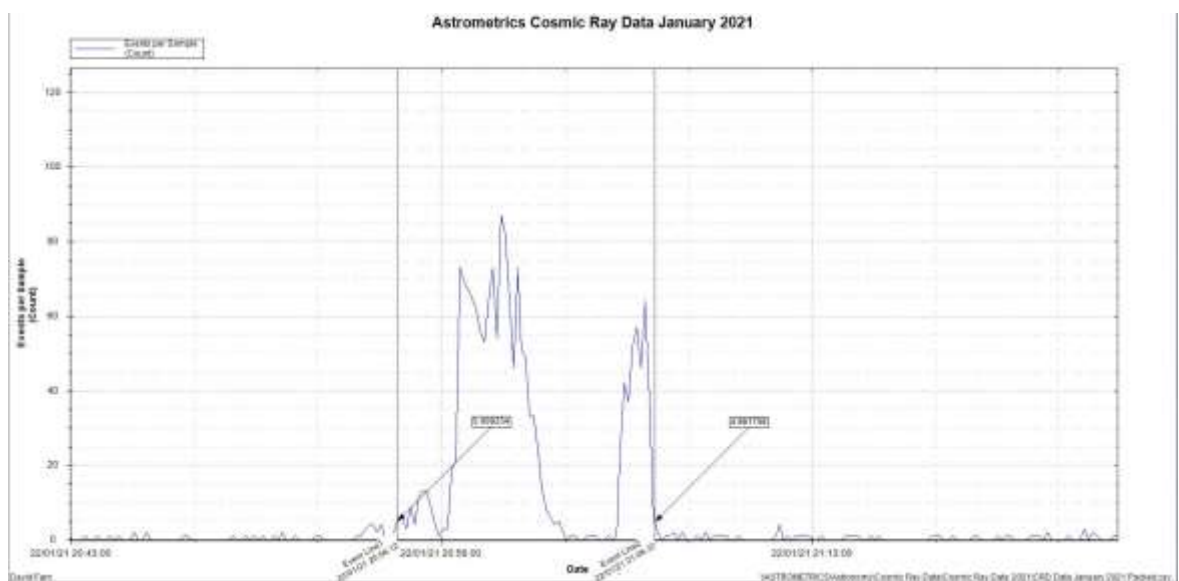
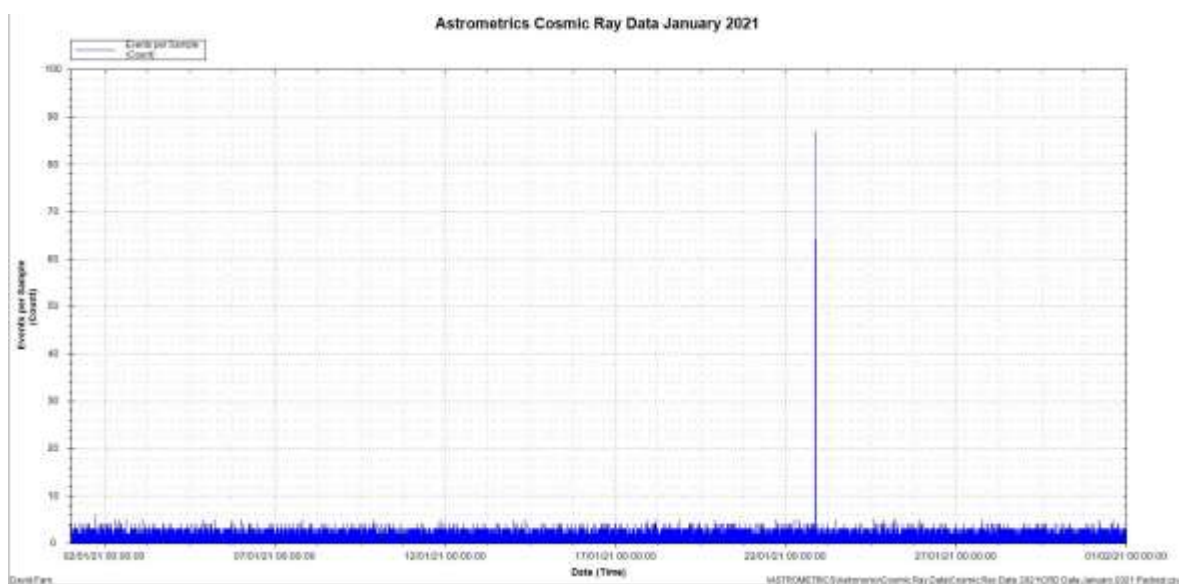

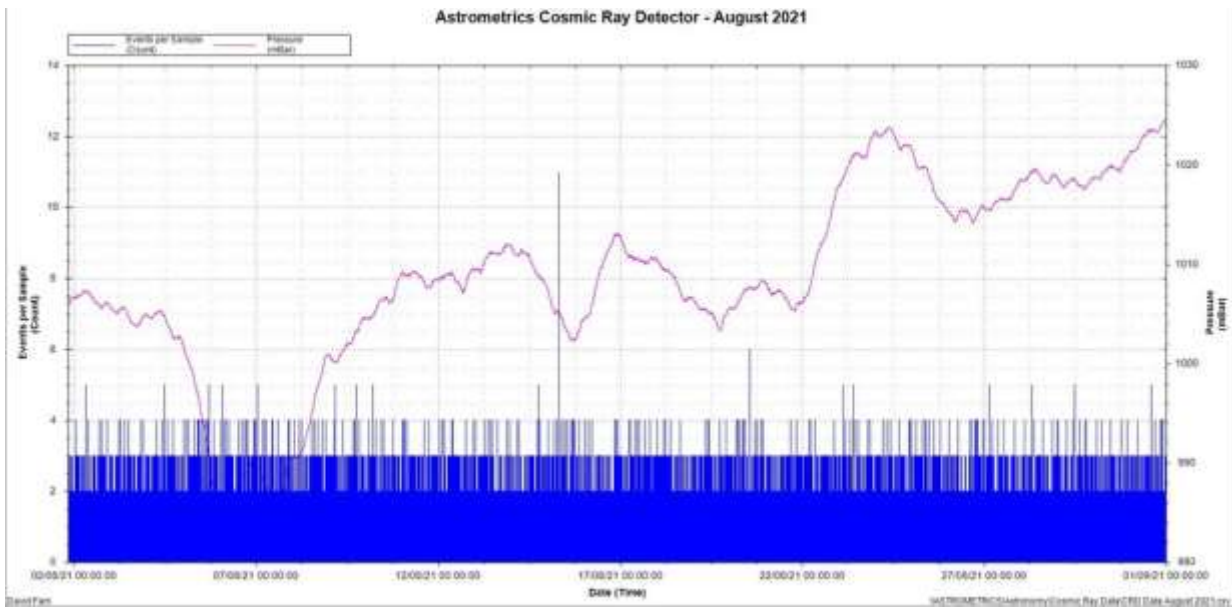

BAA Radio Astronomy Section

2021 OCTOBER

The first three weeks of October were very quiet, with mostly B-class flares and a few small C-class. The M1.6 on the 9th was therefore quite a surprise. Peaking at 06:33 UT, it was too early for UK observers, but was recorded by Roberto Battaiola in Milan, Italy. The appearance of AR12887 started a far more active period in the last week of the month, including the second X-class flare recorded so far in solar cycle 25.

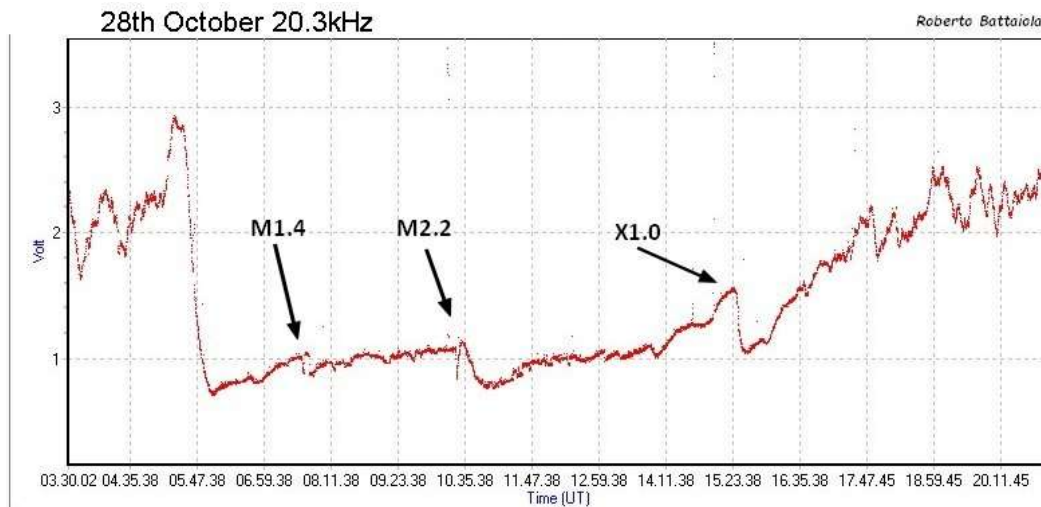

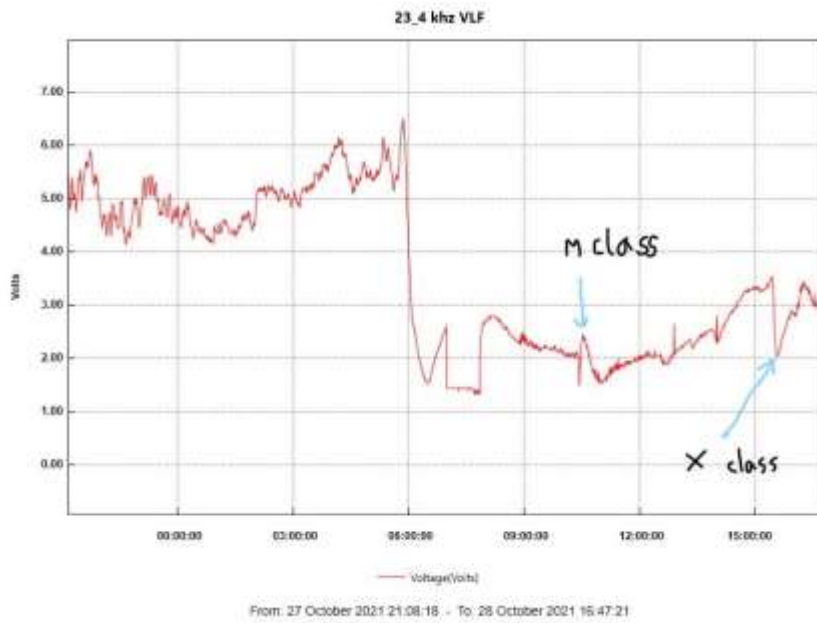

The first recording is from Roberto Battaiola, our most southerly observer, while the second is from Phil Rourke in Dundee, Scotland, our most northerly observer. Both show a clear SID from the M2.2 and X1.0 flares, the X1.0 conveniently timed just before sunset takes over.

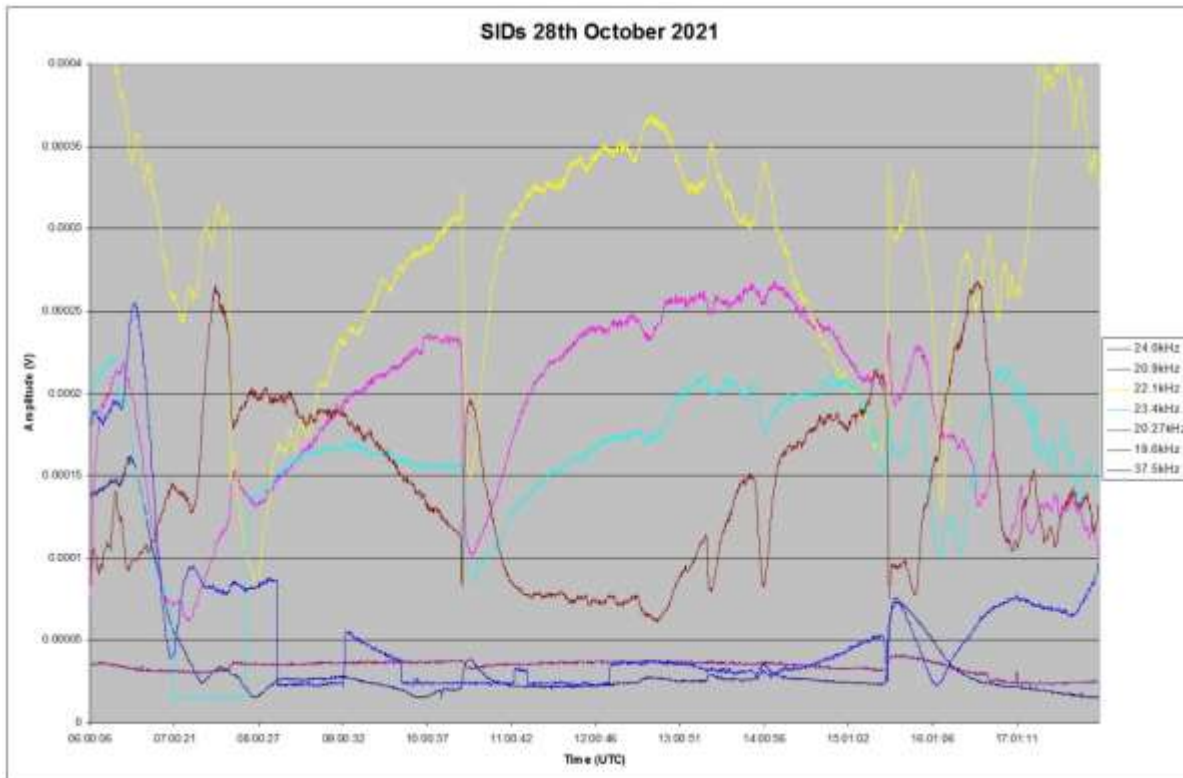

This recording from Mark Edwards (central England) shows a wide range of SID shapes from all of the flares on the 28th. 19.6 kHz (brown trace) and 22.1 kHz (yellow) show very similar inverted responses to the X1.0 flare.

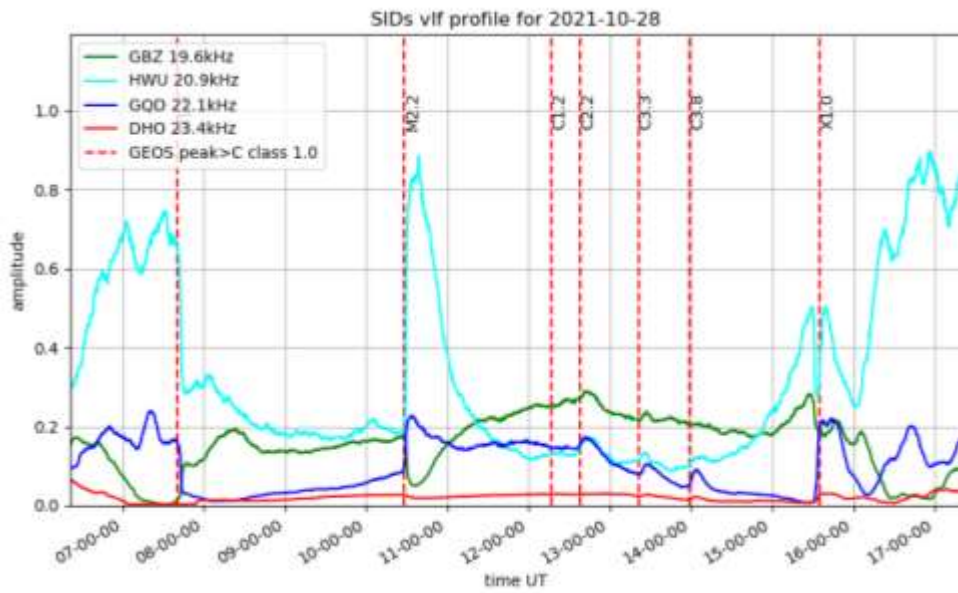

Mark Prescott has added the peak timings for each of the flares to his recording. This helps to identify the 'peak and wave' SID from the M2.2 flare, as well as the unusual 20.9 kHz SID from the X1.0 flare.

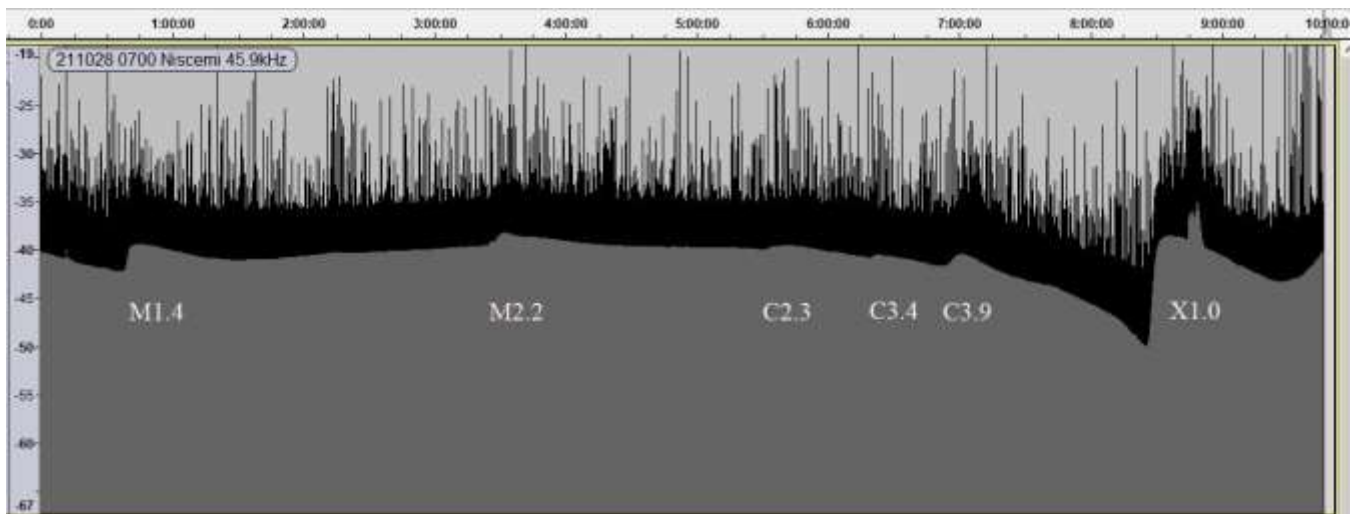

Colin Briden recorded the 45.9 kHz signal from Niscemi, Italy, SIDs showing in the grey area, black indicating the raw signal data. Here all of the flares have produced ordinary 'shark fin' SIDs.

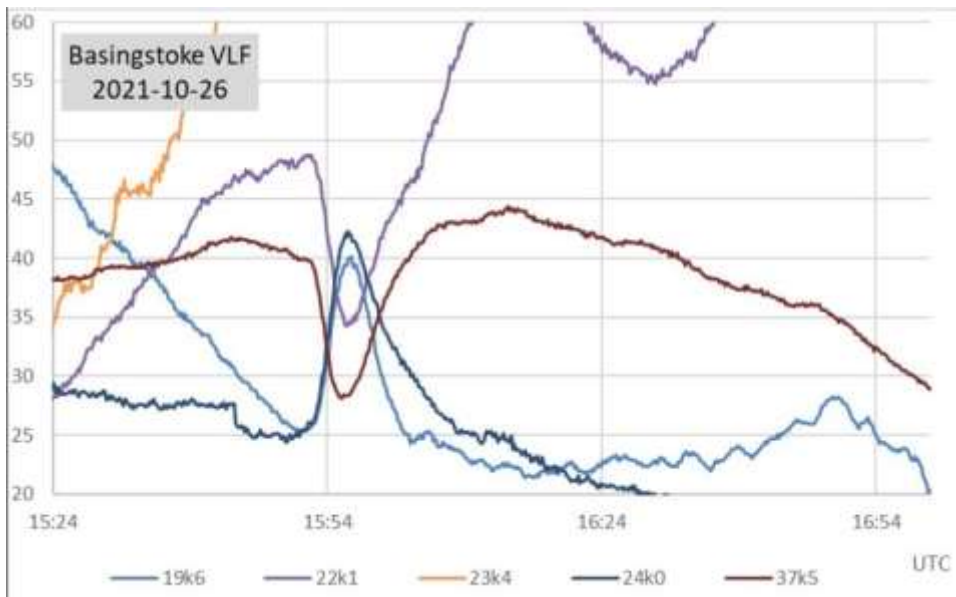

This recording from Paul Hyde shows the M1.0 flare peaking at 15:56 UT on the 26th. The 23.4 kHz signal is rising steeply into the sunset, but the other signals all show good clean SIDs.

MAGNETIC OBSERVATIONS

The X1.0 flare also produced a very small SFE, the second recorded so far in solar cycle 25. My own recording on the next page shows a barely visible 'bump' in the green magnetometer trace of about 2 nT directly above the peak of the flare. Compare its magnitude with the disturbance from parking the car on my drive at 14:18. It was also barely visible on Roger Blackwell's recording, but does show clearly on the recording from Stuart Green, shown below.

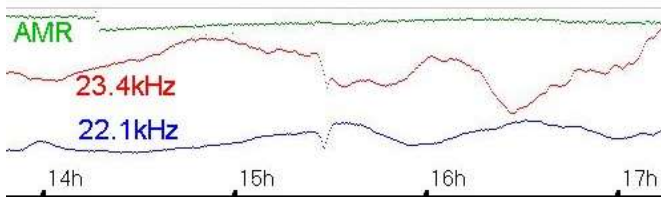

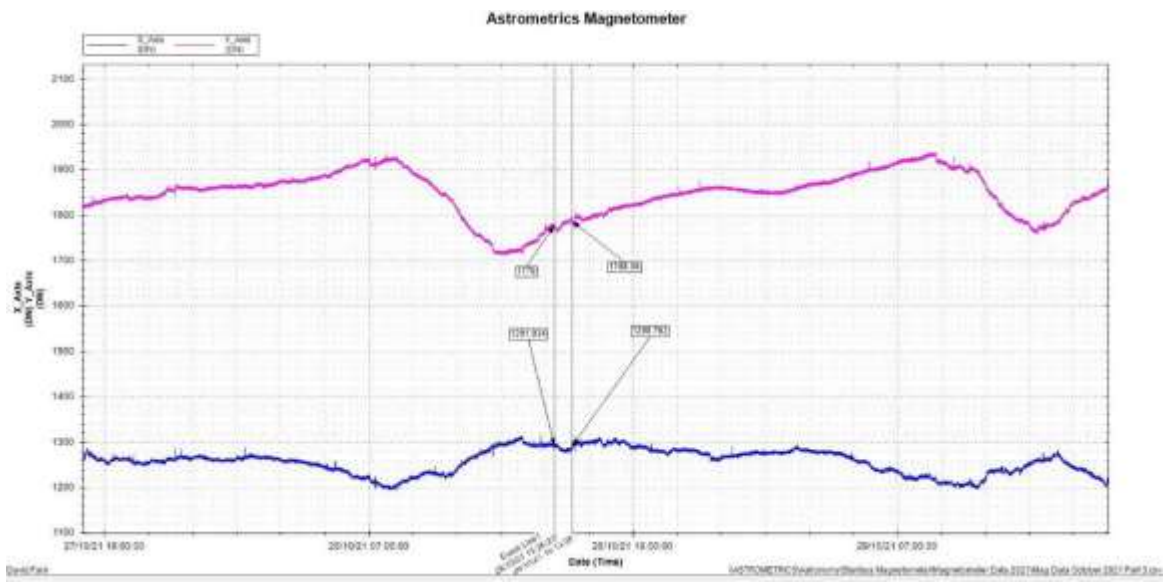
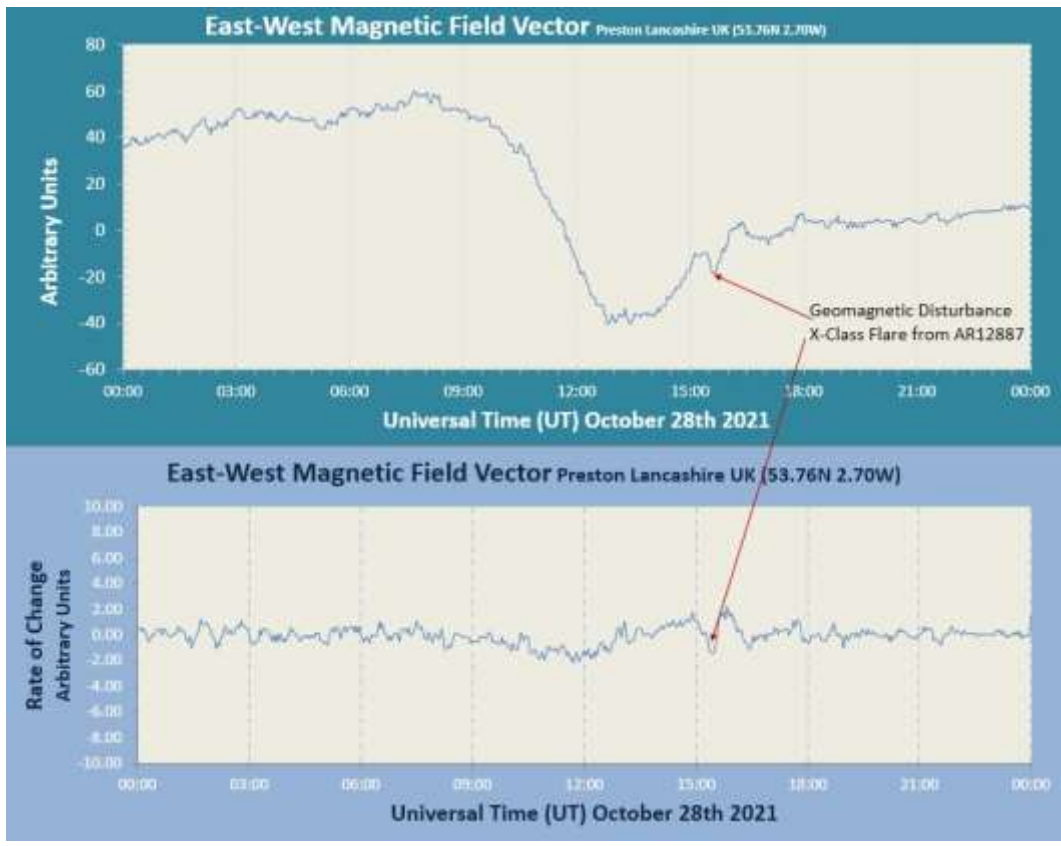

This recording by David Farn also shows a much clearer SFE response.

The first chart is from Roger Blackwell, showing the strength of activity over the two days. Some data has been lost around midnight on both days. The second chart is from Nick Quinn, showing the overnight period, and clearly showing the arrival of the CME at about 02:30 UT on the 12th

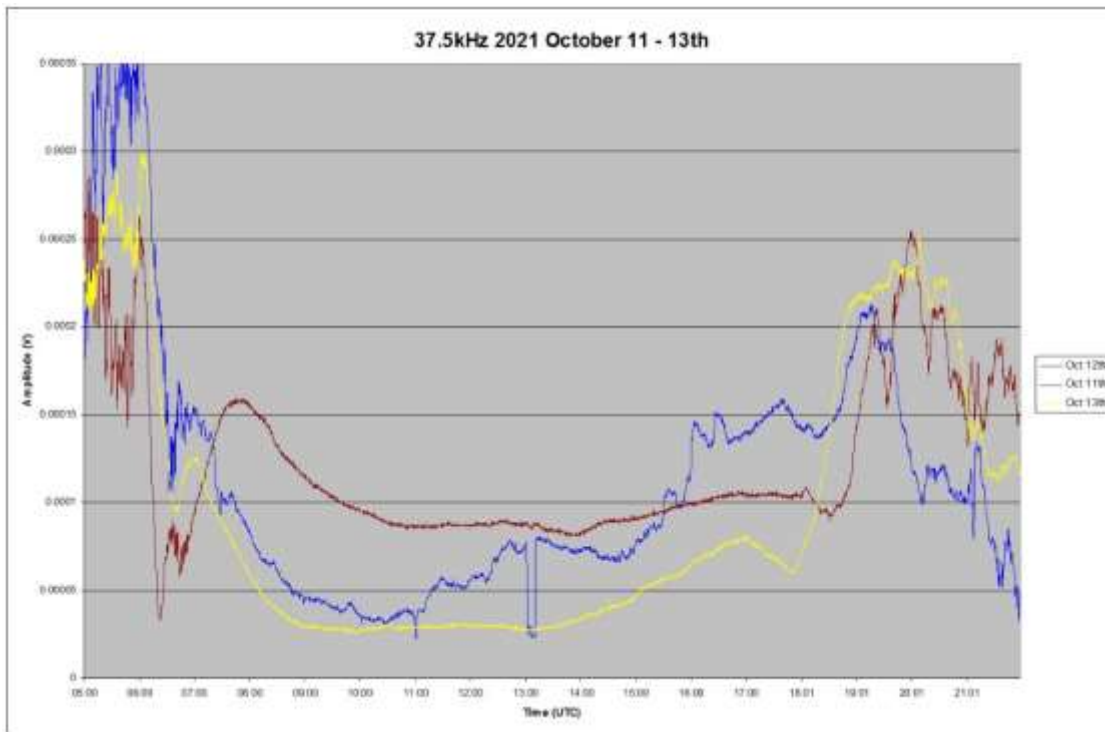

This magnetic activity was also recorded on the 37.5 kHz signal by Mark Edwards. The chart shows the 12th in blue, with the 11th and 13th in brown and yellow. There appears to be a signal drop-out just after 13:00 on the 12th, but the rest of the day is clearly very disturbed. Colin Clements also recorded a similar disturbance at 37.5 kHz, matching well with Mark’s timings.

The X1.0 flare also produced a CME, resulting in disturbances on the 30th and 31st. This shows well in the recording by Nick Quinn:

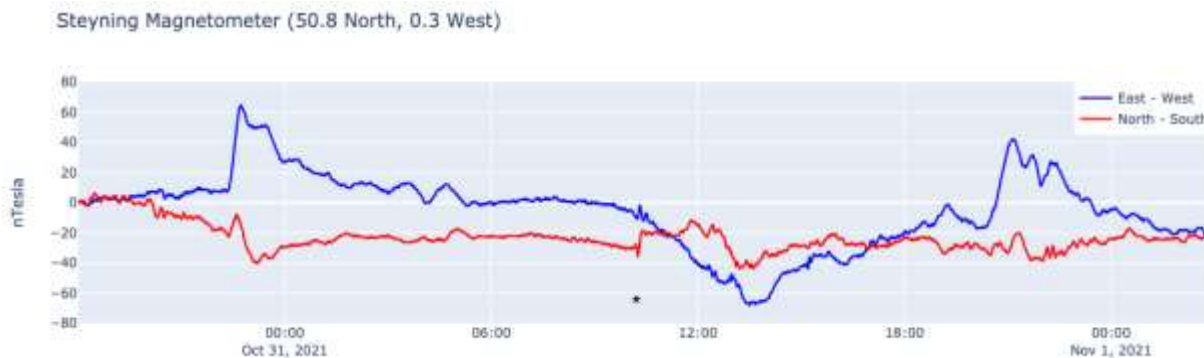

There was already a disturbance present just before midnight on the 30th, with mild conditions continuing into the morning of the 31st. The CME arrival can be seen at about 10:20 UT on the 31st, marked by ‘*’ on the chart. With our peak SID timing around 15:30 on the 28th, this gives a CME transit time of 66 hours 50 minutes. It is the 21st fastest that we have recorded since 2005, the fastest being 34h 41m on 2012 March 7th. This was close to the first peak of solar cycle 24 activity. The disturbance continued through the day and into November 1st, but was fairly mild as it was only the very edge of the CME that hit Earth.

Following the report of a possible magnetic effect at 37.5 kHz on September 21st shown in last month's summary, Stuart Green made further analysis of his data, and found that there was indeed a magnetic transient that matched well with the timing on Mark Edward's chart. Magnetic observations received from Roger Blackwell, Colin Clements, Stuart Green, Nick Quinn and John Cook.

ORIONID METEORS

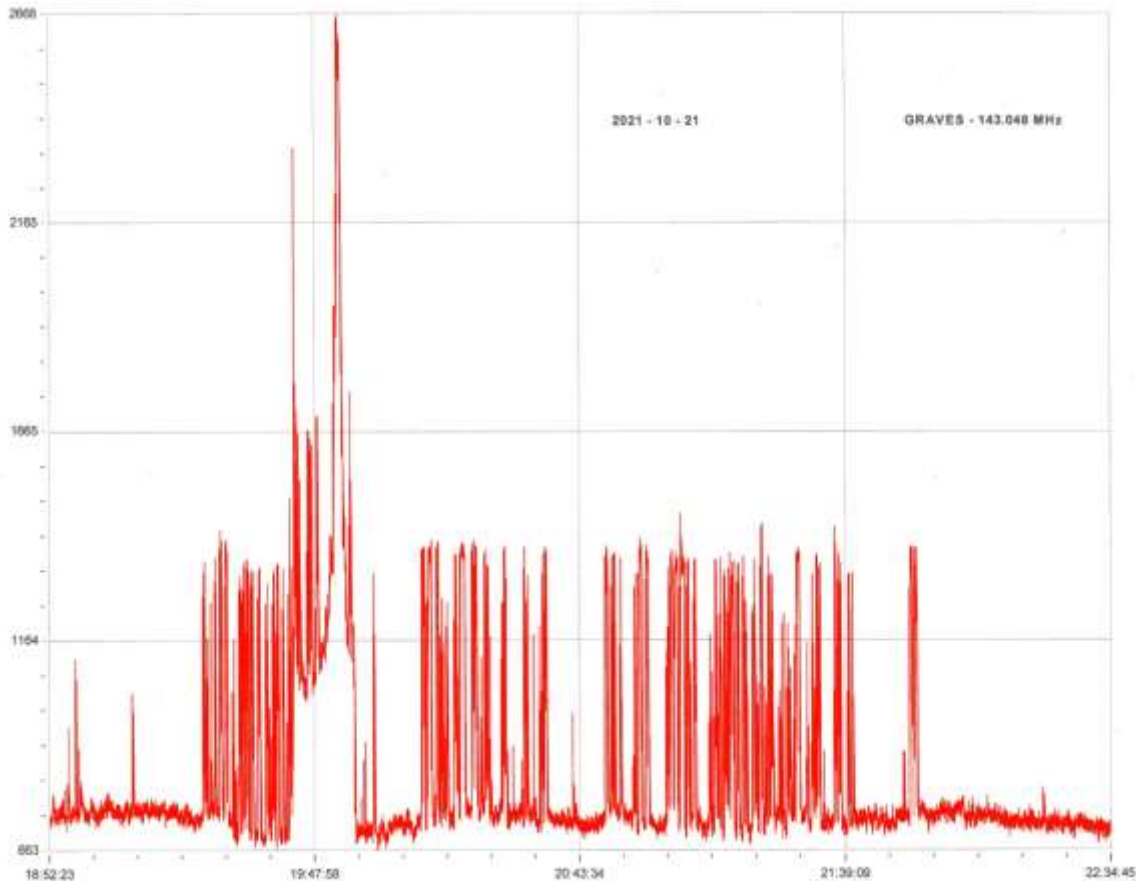

Colin Clements made this recording of echoes from the GRAVES 143 MHz signal on the 21st. Some very strong echos show around 19:50UT. Peaks in activity show for about 20 minutes starting at 19:24 and at 21:10. This period of activity does seem very short and abrupt for the Orionid meteors, with nothing recorded into the early morning as would normally be expected. We have not received any other recordings, so there is unfortunately no comparison. Stuart Green did catch some echoes on the 6th, possibly from the anticipated Arid meteors. These were expected to be below the horizon from the UK, so again the link is uncertain.

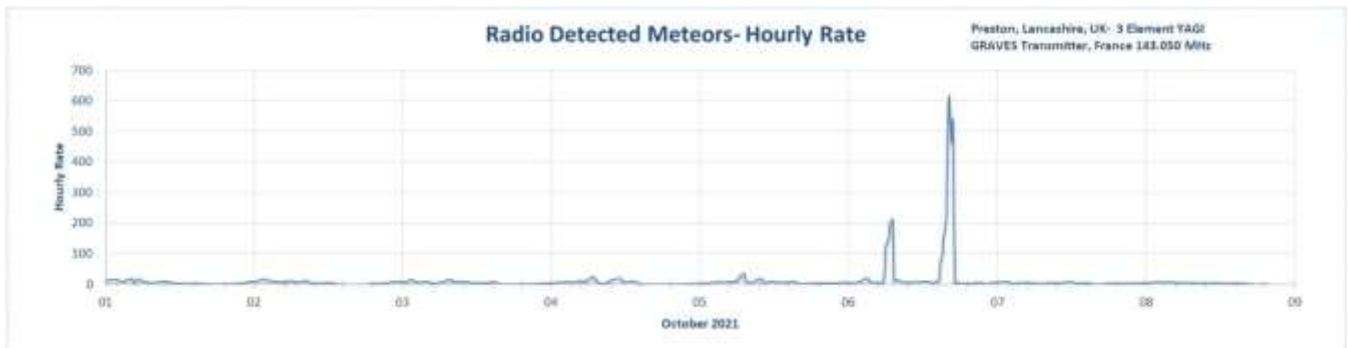

HYDROGEN LINE OBSERVATIONS

As a 'lock-down project' last year, Mark Prescott decided to try making Hydrogen line observations. Starting with a horn antenna, a low noise amplifier and software-defined radio, data was recorded onto a Raspberry Pi 4B module. This was able to record some low-resolution signals.

Adding a 0.9 m x 0.6 m parabolic grid antenna, Mark then made a series of twenty-one 24-hour drift scans over a range of 1418.8 MHz to 1421.2 MHz with the antenna in a fixed position. Observations were then repeated with the antenna pointing at different altitude and azimuth angles. Some home-written python3 code was used to process the spectra, removing noise and smoothing to create maps from the data.

The first chart shows the data from the individual drift scans, overlaid onto a map of the Milky Way. The second chart shows the smoothed data signal-to-noise ratio over the area observed. The strongest signals follow the known position of the galactic arms extremely well. The data was also used to calculate the galactic rotation curve, with results closely matching those derived from the ESA GAIA survey data.

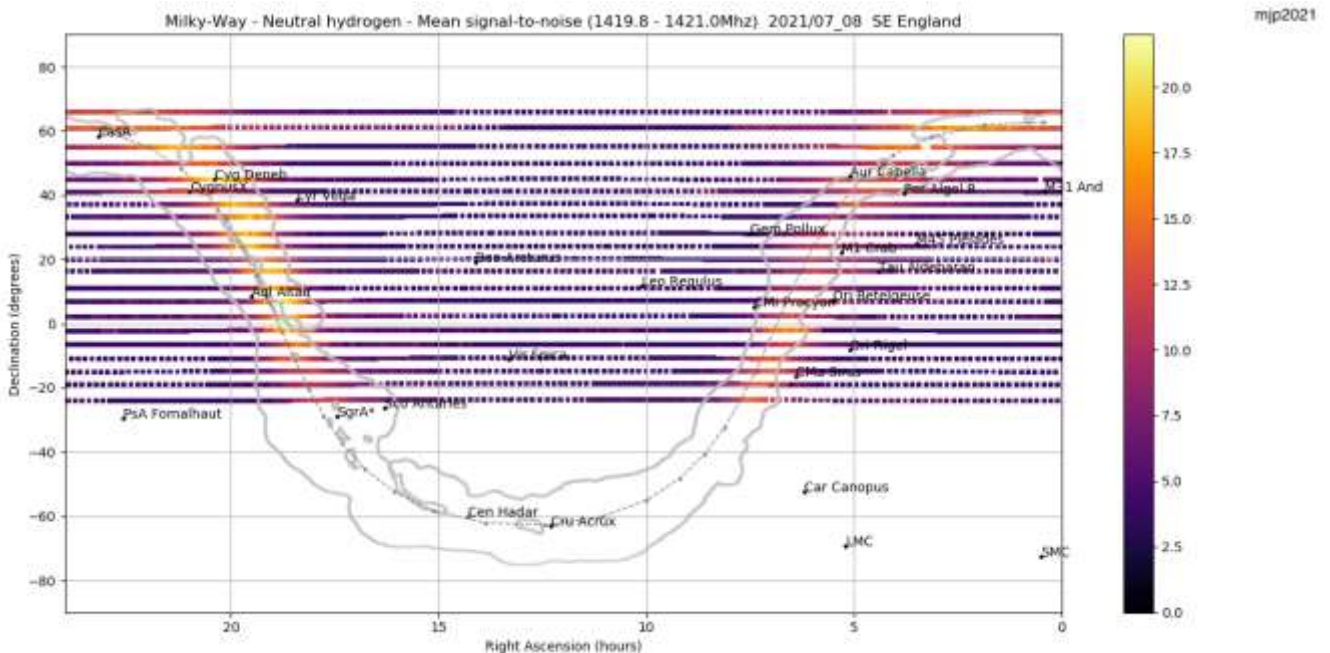

VLF flare activity 2005/21

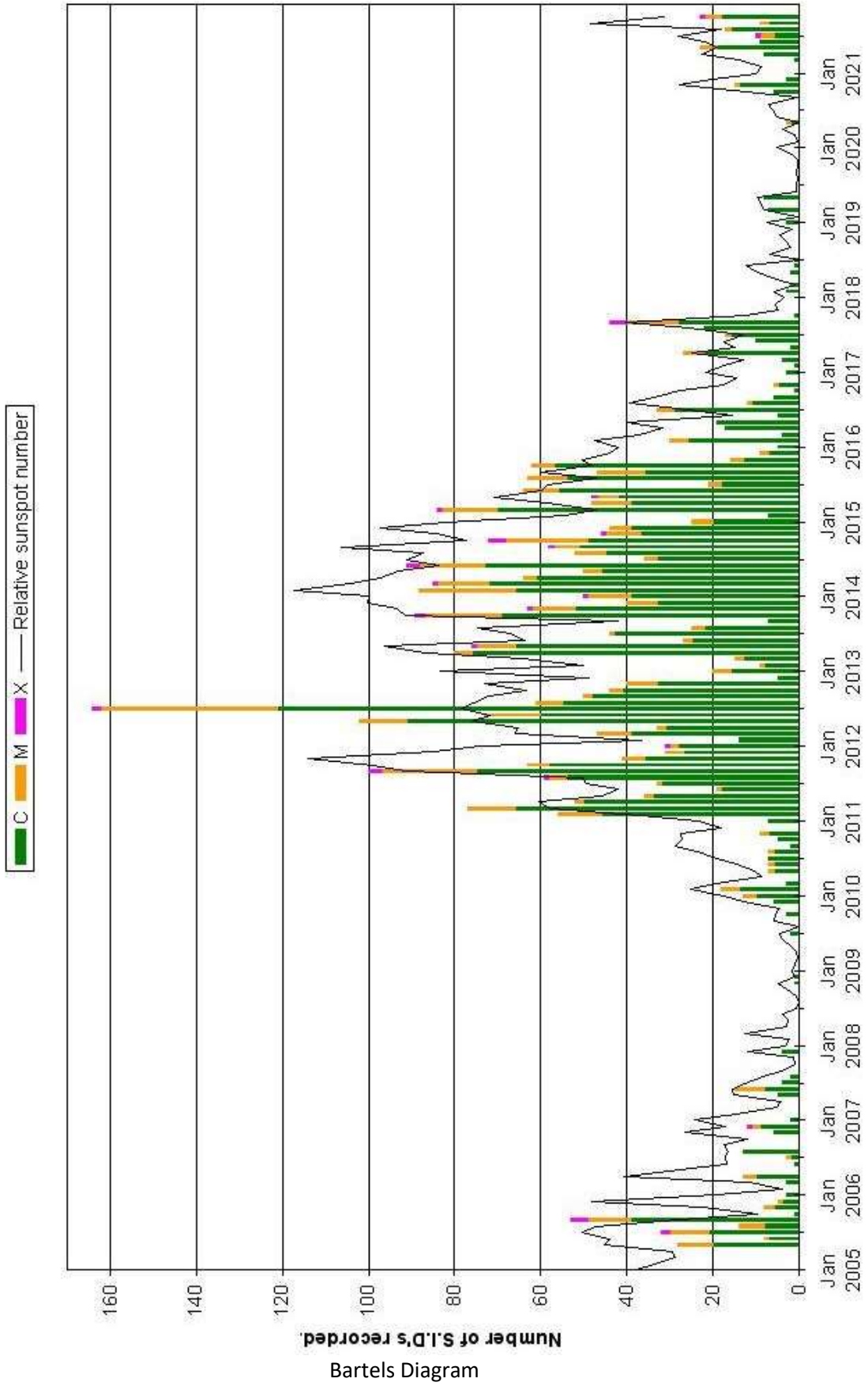

Instance	HEP	Disturbed	Active	SFE	B, C, M, X+ Flare Magnitude	Synodic rotation start (beginning)																																																									
2529	F	25	26	27	28	29	30	31	2019 January	2019	2	3	4	5	6	7	8	9	10	11	12	13	14	15	16	17	18	19	20	21																																	
2530	F	22	23	24	25	26	27	28	29	30	2019 February	2019	1	2	3	4	5	6	7	8	9	10	11	12	13	14	15	16	17																																		
2531	F	18	19	20	21	22	23	24	25	26	2019 March	2019	1	2	3	4	5	6	7	8	9	10	11	12	13	14	15	16	17																																		
2532	F	15	16	17	18	19	20	21	22	23	24	25	26	27	28	29	30	31	2019 April	2019	1	2	3	4	5	6	7	8	9	10	11	12																															
2533	F	13	14	15	16	17	18	19	20	21	22	23	24	25	26	27	28	29	30	2019 May	2019	1	2	3	4	5	6	7	8	9																																	
2534	F	10	11	12	13	14	15	16	17	18	19	20	21	22	23	24	25	26	27	28	29	30	31	2019 June	2019	1	2	3	4	5																																	
2535	F	6	7	8	9	10	11	12	13	14	15	16	17	18	19	20	21	22	23	24	25	26	27	28	29	30	2019 July	2019	1	2	3	4	5																														
2536	F	3	4	5	6	7	8	9	10	11	12	13	14	15	16	17	18	19	20	21	22	23	24	25	26	27	28	29	30	2019 August	2019	1	2	3	4	5																											
2537	F	30	31	2019 August	2019	1	2	3	4	5	6	7	8	9	10	11	12	13	14	15	16	17	18	19	20	21	22	23	24	25																																	
2538	F	28	29	30	2019 September	2019	1	2	3	4	5	6	7	8	9	10	11	12	13	14	15	16	17	18	19	20	21	22	23	24	25																																
2539	F	22	23	24	25	26	27	28	29	30	2019 October	2019	1	2	3	4	5	6	7	8	9	10	11	12	13	14	15	16	17	18	19	20																															
2540	F	18	19	20	21	22	23	24	25	26	27	28	29	30	31	2019 November	2019	1	2	3	4	5	6	7	8	9	10	11	12	13	14																																
2541	F	15	16	17	18	19	20	21	22	23	24	25	26	27	28	29	30	2019 December	2019	1	2	3	4	5	6	7	8	9	10	11	12	13	14																														
2542	F	12	13	14	15	16	17	18	19	20	21	22	23	24	25	26	27	28	29	30	31	2019 January	2020	1	2	3	4	5	6	7	8	9	10	11	12	13	14																										
2543	F	8	9	10	11	12	13	14	15	16	17	18	19	20	21	22	23	24	25	26	27	28	29	30	31	2020 February	2020	1	2	3	4	5	6	7	8	9	10	11	12	13	14																						
2544	F	5	6	7	8	9	10	11	12	13	14	15	16	17	18	19	20	21	22	23	24	25	26	27	28	29	30	2020 March	2020	1	2	3	4	5	6	7	8	9	10	11	12	13	14	15	16	17	18	19	20	21	22	23	24	25	26	27	28	29	30	31			
2545	F	2	3	4	5	6	7	8	9	10	11	12	13	14	15	16	17	18	19	20	21	22	23	24	25	26	27	28	29	30	2020 April	2020	1	2	3	4	5	6	7	8	9	10	11	12	13	14	15	16	17	18	19	20	21	22	23	24	25	26	27	28	29	30	31
2546	F	29	30	2020 May	2020	1	2	3	4	5	6	7	8	9	10	11	12	13	14	15	16	17	18	19	20	21	22	23	24	25	26	27	28	29	30	31																											
2547	F	25	26	27	28	29	30	2020 May	2020	1	2	3	4	5	6	7	8	9	10	11	12	13	14	15	16	17	18	19	20	21	22	23	24	25	26	27	28	29	30	31																							
2548	F	22	23	24	25	26	27	28	29	30	2020 June	2020	1	2	3	4	5	6	7	8	9	10	11	12	13	14	15	16	17	18	19	20	21	22	23	24	25	26	27	28	29	30	31																				
2549	F	18	19	20	21	22	23	24	25	26	27	28	29	30	2020 July	2020	1	2	3	4	5	6	7	8	9	10	11	12	13	14	15	16	17	18	19	20	21	22	23	24	25	26	27	28	29	30	31																
2550	F	15	16	17	18	19	20	21	22	23	24	25	26	27	28	29	30	31	2020 August	2020	1	2	3	4	5	6	7	8	9	10	11	12	13	14	15	16	17	18	19	20	21	22	23	24	25	26	27	28	29	30	31												
2551	F	11	12	13	14	15	16	17	18	19	20	21	22	23	24	25	26	27	28	29	30	31	2020 September	2020	1	2	3	4	5	6	7	8	9	10	11	12	13	14	15	16	17	18	19	20	21	22	23	24	25	26	27	28	29	30	31								
2552	F	7	8	9	10	11	12	13	14	15	16	17	18	19	20	21	22	23	24	25	26	27	28	29	30	31	2020 October	2020	1	2	3	4	5	6	7	8	9	10	11	12	13	14	15	16	17	18	19	20	21	22	23	24	25	26	27	28	29	30	31				
2553	F	4	5	6	7	8	9	10	11	12	13	14	15	16	17	18	19	20	21	22	23	24	25	26	27	28	29	30	2020 November	2020	1	2	3	4	5	6	7	8	9	10	11	12	13	14	15	16	17	18	19	20	21	22	23	24	25	26	27	28	29	30	31		
2554	F	31	2020 November	2020	1	2	3	4	5	6	7	8	9	10	11	12	13	14	15	16	17	18	19	20	21	22	23	24	25	26	27	28	29	30	31																												
2555	F	27	28	29	30	2020 December	2020	1	2	3	4	5	6	7	8	9	10	11	12	13	14	15	16	17	18	19	20	21	22	23	24	25	26	27	28	29	30	31																									
2556	F	24	25	26	27	28	29	30	31	2021 January	2021	1	2	3	4	5	6	7	8	9	10	11	12	13	14	15	16	17	18	19	20	21	22	23	24	25	26	27	28	29	30	31																					
2557	F	20	21	22	23	24	25	26	27	28	29	30	31	2021 February	2021	1	2	3	4	5	6	7	8	9	10	11	12	13	14	15	16	17	18	19	20	21	22	23	24	25	26	27	28	29	30	31																	
2558	F	16	17	18	19	20	21	22	23	24	25	26	27	28	29	30	2021 March	2021	1	2	3	4	5	6	7	8	9	10	11	12	13	14	15	16	17	18	19	20	21	22	23	24	25	26	27	28	29	30	31														
2559	F	13	14	15	16	17	18	19	20	21	22	23	24	25	26	27	28	29	30	31	2021 April	2021	1	2	3	4	5	6	7	8	9	10	11	12	13	14	15	16	17	18	19	20	21	22	23	24	25	26	27	28	29	30	31										
2560	F	11	12	13	14	15	16	17	18	19	20	21	22	23	24	25	26	27	28	29	30	31	2021 May	2021	1	2	3	4	5	6	7	8	9	10	11	12	13	14	15	16	17	18	19	20	21	22	23	24	25	26	27	28	29	30	31								
2561	F	8	9	10	11	12	13	14	15	16	17	18	19	20	21	22	23	24	25	26	27	28	29	30	31	2021 June	2021	1	2	3	4	5	6	7	8	9	10	11	12	13	14	15	16	17	18	19	20	21	22	23	24	25	26	27	28	29	30	31					
2562	F	4	5	6	7	8	9	10	11	12	13	14	15	16	17	18	19	20	21	22	23	24	25	26	27	28	29	30	31	2021 July	2021	1	2	3	4	5	6	7	8	9	10	11	12	13	14	15	16	17	18	19	20	21	22	23	24	25	26	27	28	29	30	31	
2563	F	2	3	4	5	6	7	8	9	10	11	12	13	14	15	16	17	18	19	20	21	22	23	24	25	26	27	28	29	30	31	2021 August	2021	1	2	3	4	5	6	7	8	9	10	11	12	13	14	15	16	17	18	19	20										



British Astronomical Association

Supporting amateur astronomers since 1890

Radio Astronomy Section

BAA RA Section Winter programme 2022

Jan 7th 19:30 GMT (19:30 UTC)	Alexander Josephy	'CHIME, Magnetars and Fast Radio Bursts' Alex has done major foundational work both on CHIME and scientifically.
Jan 15th GNU II Training seminar 14:00 GMT (14:00 UTC)	Marcus Leach	Unpacking more mysteries of GNU Radio Canadian Centre for Experimental Radio Astronomy
Feb 4 th 19:30 GMT (19:30 UTC)	Chris Steyaert	'VHF Meteor Observations, the IMO, and corelation' Following the main presentation there will be opportunity for members to update us on their observations and techniques.
Mar 4 th 19:30 GMT (19:30 UTC) (This will be a joint session with the 'Arora and Clouds and Polar Mesosphere Summer Noctilucent Cloud' Section of the BAA.) Note: GMT to BST Sunday March 27 th .	Dr David Hooper	'Ice Crystals at the edge of space - Noctilucent Echoes' David is a STEM ambassador working for the STFC at the Rutherford Appleton Laboratory. The main presentation will be followed by Sandra Brantingham, Noctilucent Section Director.
Apr 1st 19:30 BST (18:30 UTC)	Prof. Carole Mundell	'...on Fast gamma ray bursts' Carole Mundell is Professor of Extragalactic Astronomy at the University of Bath. She is an observational astrophysicist who researches cosmic black holes and gamma ray bursts.

If you have any suggestions for the summer 2022 term do let me know. Our meetings are open to all. Once you are registered on the RA Section email list the Zoom link will be sent out to you before the meeting. If you are not on the email list, please request registration from Paul Hearn (paul@hearn.org.uk).

All recordings will be posted on our BAA YouTube channel.

<https://www.youtube.com/user/britishastronomical/playlists>

Member Comments

Comment on an FRB observation report Wolfgang Herrmann

In the September/October 2021 SARA Journal an observation report has been published where it has been suggested that the recorded signal might originate from a fast radio burst (FRB) emitted by the galactic magnetar SGR 1935+2154 [1]. This magnetar is known to have previously emitted a very strong pulse on April 28th, 2020. This strong emission was observed by the CHIME and ARO telescopes [2] and the STARE2 experiment [3] and became known as FRB200428. The observation report cited above is suggesting that another very bright pulse has been emitted by this source on June 19th, 2021 and has been recorded by the experiment described in the observation report.

Unfortunately, the recorded pulse cannot come from the suggested source for the following reason: Pulses from galactic and extragalactic radio sources such as pulsars, magnetars, and fast radio bursts are subject to dispersion. This means that signals at higher frequencies are travelling faster through the interstellar medium than at lower frequencies. This leads to a pulse broadening which is dependent on the observing frequency, the observing bandwidth and a characteristic value called “Dispersion Measure (DM)” which is specific to the observed source. The delay between the highest and lowest frequency in the observation bandwidth is described by the equation (see for example [4]):

$$\Delta t = 4.15 \cdot 10^6 \text{ ms} \cdot (f_1^{-2} - f_2^{-2}) \cdot DM \quad (1)$$

where f_1 and f_2 are given in MHz.

The observation report states 21.1 MHz as the observation frequency. The observing bandwidth is determined by the equipment used which is a Radio Jove receiver. The bandwidth of this receiver is 7 kHz [5],[6] and the DM of the putative source is 332.7 [1]. Plugging this into the equation (1) yields:

$$\Delta t = 4.15 \cdot 10^6 \text{ ms} \cdot (21.5^{-2} - 21.507^{-2}) \cdot 332.7 = 1944 \text{ ms}$$

Therefore, any pulse observed at such a low frequency will be smeared out to almost 2 seconds due to dispersion even with a narrow bandwidth of 7 kHz. As the observed signal, which is not de-dispersed, is ~ 40 ms wide, it cannot come from FRB200428/SGR1935+2154.

References

- [1] James Van Prooyen, Possible Observation of a FRB Using Radio Jove Technology, SARA Journal September-October 2021
- [2] The CHIME/FRB Collaboration. A bright millisecond-duration radio burst from a Galactic magnetar. *Nature* 587, 54–58 (2020)
- [3] Bochenek, C.D., Ravi, V., Belov, K.V. *et al.* A fast radio burst associated with a Galactic magnetar. *Nature* 587, 59–62 (2020)
- [4] D. Lorimer and M.Kramer, Handbook of Pulsar Astronomy, Cambridge University Press, 2005
- [5] https://radiojove.gsfc.nasa.gov/radio_telescope/resources/tech_talk-3.php
- [6] <http://physics.wku.edu/~gibson/radio/jove/station/>

Jim Van Prooyen Response to Wolfgang's Above Comments

I have had email from people who confirmed it, and others who said it was not possible. Comments with the calculation made by Wolfgang are very helpful, based on this I should be looking at longer periods for such events; if they can be seen with the current equipment.

Thanks for the input Wolfgang!

Time Aspects of the 12 October 2021 Geomagnetic Sudden Impulse

Whitham D. Reeve

1. Introduction

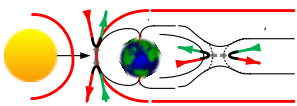

A geomagnetic *sudden impulse* (SI) is caused by the impact of a coronal mass ejection (CME) with Earth's magnetosphere. The impact suddenly compresses the magnetosphere and alters the ionospheric current systems, which, in turn, alter the magnetic field measured on the ground. Depending on the orientation of its embedded magnetic field and other factors, the CME may or may not produce a geomagnetic storm. If it produces a storm, the impulse often is called (after the fact) a *storm sudden commencement* (SSC) rather than a Sudden Impulse. If a storm does occur, it may start almost immediately after the CME arrives or sometime later. For purposes of this article, I will refer to the event of 12 October as a sudden impulse.

The question naturally arises about the timing aspects of sudden impulses measured by ground magnetometers around the world: Does a given SI register on all magnetometers at the same time – the *simultaneity hypothesis* – or is there a varying delay that depends on location – the *propagation hypothesis*? This is a tricky question because it is first necessary to define what constitutes the beginning of a sudden impulse. There also is the problem of interpreting magnetic field data, which could be affected by the impulse shape (waveform) at the location of the observation and the response, sampling rate and timing accuracy of the magnetometer at that location.

Attempts at answering the question of simultaneity or propagation have a long history. A conclusion drawn in 1933 after long and dedicated studies was that a given sudden impulse would occur “almost simultaneously on the Earth” {[HGSS21](#)}. Just exactly what does “almost simultaneously” mean? The referenced study does not provide an answer. In the 1966 book *Electromagnetism and the Earth's Interior*, the author states “The time of the outbreak of an SSC is simultaneous over the earth within an accuracy of 1 minute” [Rikitake]. Out of curiosity, the question is investigated here based on measurements at four widely separated ground locations using SAM-III magnetometers.

Throughout solar cycle 24 from December 2008 to December 2019 and during the early stages of solar cycle 25, many sudden impulses were observed and recorded by the SAM-III magnetometer at Anchorage, Alaska and reported {[ReeveWeb](#)}. A detailed investigation of sudden impulses from 1 June 2012 to 1 June 2013 observed at Anchorage discussed waveforms and other characteristics {[Reeve13](#)}. An article in mid-2021 compared the time of a sudden impulse on 12 May that was recorded both at Anchorage and Isle of Mull in Scotland {[Reeve21](#)}. The current article compares the sudden impulse times for the 12 October event observed at four stations including those at Anchorage and Isle of Mull.

2. Event description

An M1.6 solar flare on 9 October produced a CME that intercepted Earth on 12 October. The resulting sudden impulse was reported by Space Weather Prediction Center to occur at 0230 UTC with an amplitude of 33 nT as measured at the Geomagnetic Observatory Wingst (WNG) in Germany [{SWPC-1}](#). As discussed below, this event was observed at slightly different times and at different amplitudes at four ground magnetometers around the world.

The CME was modeled by the Space Weather Forecast Office (part of NOAA in the USA) in terms of plasma density and radial wind velocity using the 3-dimensional Wang-Sheeley-Arge-Enlil solar wind prediction model [{WSA-Enlil}](#). One of the images from the model for 12 October shows what was predicted (figure 1). The model predicted an increase in solar wind speed at Earth from around 300 km s^{-1} to about 600 km s^{-1} as well as a spike in density as the CME enveloped the geomagnetosphere. According to the model, the CME was very large and did not simply graze the geomagnetosphere.

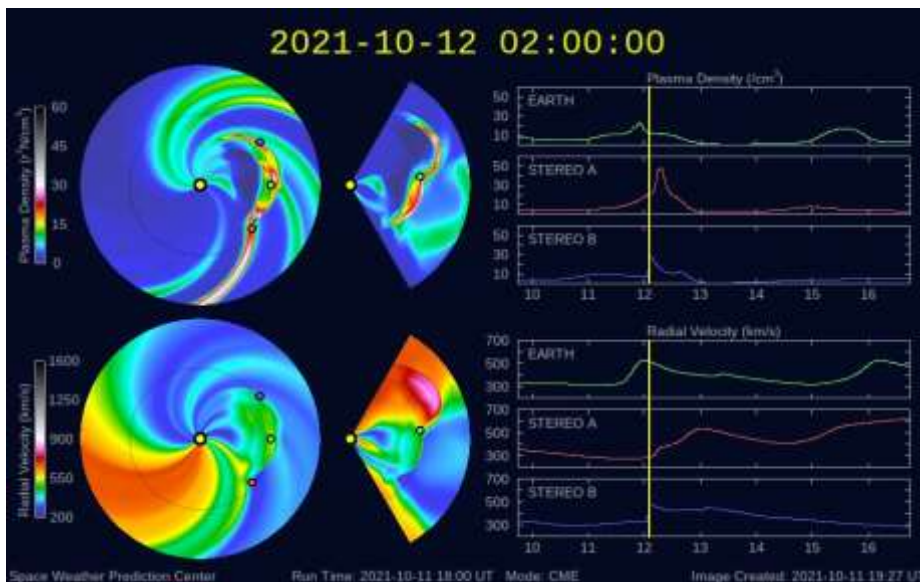

Figure 1 ~ The left circular images represent the Sun and Earth as viewed from above the ecliptic and the right pie-shaped images are viewed along the ecliptic. The Sun is in the center of the left circles and at the apex of the right pie-pieces. Earth is the small circle about 1/2-way to the right. The image shown here is the prediction for 0200, about 30 minutes before the actual CME impact. Note that the top images predicted a spike in the plasma density – CME impact – a few hours before the actual impact. Image source: [{WSA-Enlil}](#)

The SWPC *Forecast Discussion* report issued on 12 October at 0030, two hours before CME arrival, stated that updated modeling showed the CME speed to be about 900 km s^{-1} [{SWPC-1}](#). The interplanetary (IP) shock passage was detected at the DSCOVR spacecraft (figure 2) at 0147 UTC on 12 October [{SWPC-2}](#), and the sudden impulse was detected by the SAM-III magnetometers 40 min later at about 0227. The distance traveled from DSCOVR to Earth's magnetosphere is approximately 1.44 million km, so the actual CME speed was closer to 600 km s^{-1} .

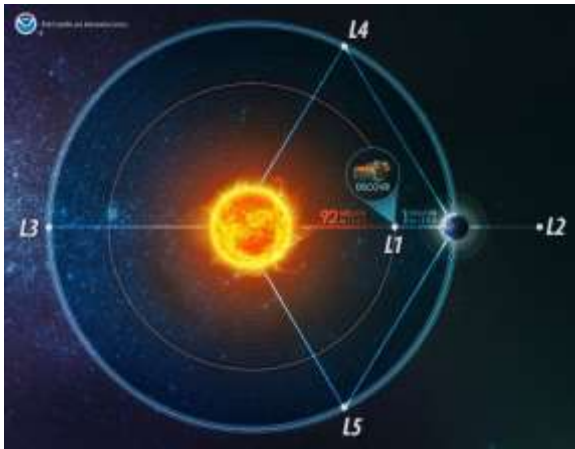

Figure 2 ~ View looking down on the ecliptic plane that shows the Lagrange points defined by the Sun-Earth system. The Deep Space Climate Observatory (DSCOVR) spacecraft is located at the L1 Lagrange point, 1.5 million km toward the Sun from Earth's center. The geomagnetosphere extends roughly 10 Earth radii toward the Sun, or around 64 thousand km. The spacecraft is a sentinel that provides approximately 15 to 60 min warning of coronal mass ejections, solar storms and other severe space weather headed toward Earth. Image source: {[NASA](#)}

Before CME impact, the geomagnetosphere already had been disturbed by enhanced solar winds and the auroral oval already had expanded and pushed the auroral electrojet to lower latitudes. It is noted that the auroral oval is considered to indicate the division between opened and closed geomagnetic field lines. Opened field lines reach outside the magnetosphere whereas closed field lines loop back to Earth within the magnetosphere. The auroral oval is represented by graphics on the University of Alaska – Geophysical Institute Aurora Forecasts webpage {[Aurora](#)}. On 11 and 12 October, the auroral oval easily covered Anchorage and its southern edge reached Isle of Mull (figure 3). The importance of the auroral oval is discussed in section 4.

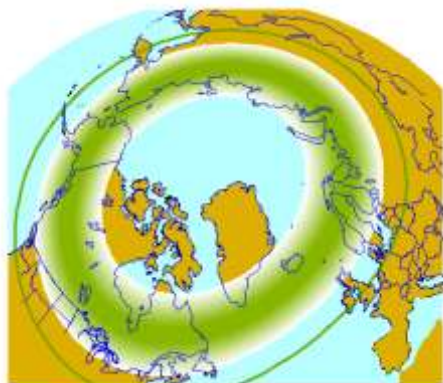

Figure 3 ~ The auroral oval, shown in this drawing as a green donut centered on the magnetic north pole, is for 11 October, the day before the CME impact. It was substantially the same on 12 October. The oval marks the region in which observations of the aurora have a high probability. It exists in both hemispheres and as a first approximation is fixed with respect to the Sun as Earth rotates below it. At solar midnight, the maximum of the auroral oval is centered about 67° latitude, but it extends to 77° at solar noon. Magnetic disturbances cause the oval to expand to both lower and higher latitudes. Image source: {[Aurora](#)}

3. Observations

Data were obtained from four widely separated SAM-III magnetometer stations (table 1, figure 4) to examine the timing of the 12 October sudden impulse.

Table 1 ~ SAM-III magnetometer geographic and geomagnetic coordinates. See acknowledgements in section 6.

Station	Geographic Coordinates	Geomagnetic Coordinates*	Contact
Anchorage, Alaska USA	61.199° N; 149.957° W	61.72° N; 94.50° W	Whitham D. Reeve
Isle of Mull Scotland	56.380° N; 6.001° W	58.85° N; 80.86° E	Roger Blackwell
Coonabarabran, New South Wales Australia	31.26° S; 149.22° E	37.82° S; 133.62° W	Michael Andre Phillips
Fort Collins, Colorado USA	40.502° N; 105.087° W	47.99° N; 37.65° W	Rodney Howe

* Coordinate transformation for 2021 using the IGRF-13 {[Kyoto](#)}

Differences in sudden impulse times and amplitudes were recorded by the four stations (table 2). Not shown in the table is the time reported by SWPC {[SWPC-2](#)}, which was 0230 UTC, about 3 min later than the four observations discussed here. SWPC reported an amplitude of 33 nT. The time difference may be due to the way SWPC interprets its data (see {[Reeve13](#)}). The differences in amplitude are due to the different geographic/geomagnetic locations of the magnetometers and, possibly, their sensitivities. The SAM-III magnetometer are operated as variometers with uncalibrated sensors.

The SAM-III magnetometer sensors at the four stations are oriented according to the Geographic Coordinate System and produce measurements at ground level for the X (north-south), Y (east-west) and Z (vertical) components. The data for the X- and Y-components are transformed to a Horizontal (H) component according to

$$H = \sqrt{X^2 + Y^2} .$$

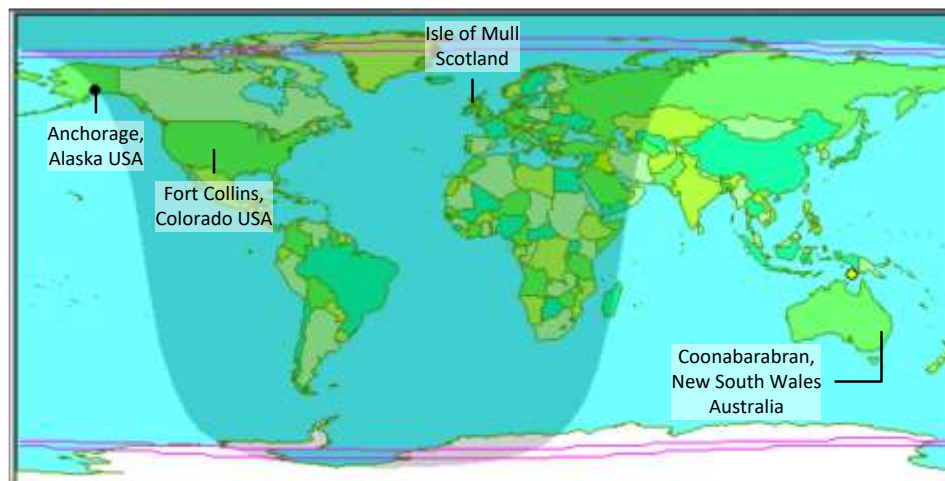

Figure 4 ~ Solar terminator at 0230 UTC on 12 October with marked station locations. The station locations with respect to the Sun were: Anchorage, Alaska USA – On sunset solar terminator; Isle of Mull, Scotland – Near solar midnight; Coonabarabran, New South Wales Australia – Near solar noon (see yellow circle, which represents the Sun); Fort Collins, Colorado USA – about 2 h after local sunset. Underlying image source: {DXViewer}

Table 2 ~ Sudden impulse (SI) observations and magnetometer sample rates. SI amplitudes are based on the H-component of the magnetic field as plotted below and are the differences between the knee (when the amplitude breaks and increases sharply) and the peak amplitude. SI Time is the time of the knee, which has about 10 s ambiguity.

Station (in order of occurrence)	SI time (UTC)	SI amplitude (nT)	Sample rate (Hz)
Isle of Mull Scotland	02:26:36	31	0.1
Fort Collins, Colorado USA	02:26:48	42	0.1
Coonabarabran, New South Wales Australia	02:26:56	30	0.1
Anchorage, Alaska USA	02:27:02	73	0.1
Averages	02:26:51	44	
Standard Deviations	10 s	17	

For comparison, the H-component at each station is normalized to the amplitude measured at 0215:00 UTC and then plotted together (figure 5). Also shown are Individual plots of the normalized H-component data from each station for the time period 0215 to 0245 UTC (figure 6). *Solar Local Time* (SLT) for each station is shown on a clock dial (figure 7) as well as given in the caption for the individual impulse plots. SLT indicates the relative position of the Sun without regard to local time. It is 00 in the anti-sunward direction (solar local midnight), 12 in the sunward direction (solar local noon) and 06 (dawn) and 18 (dusk) perpendicular to the sunward/anti-sunward line. SLT is similar to but not the same as *Magnetic Local Time*, which takes into account the local magnetic longitude and location of the magnetic north pole.

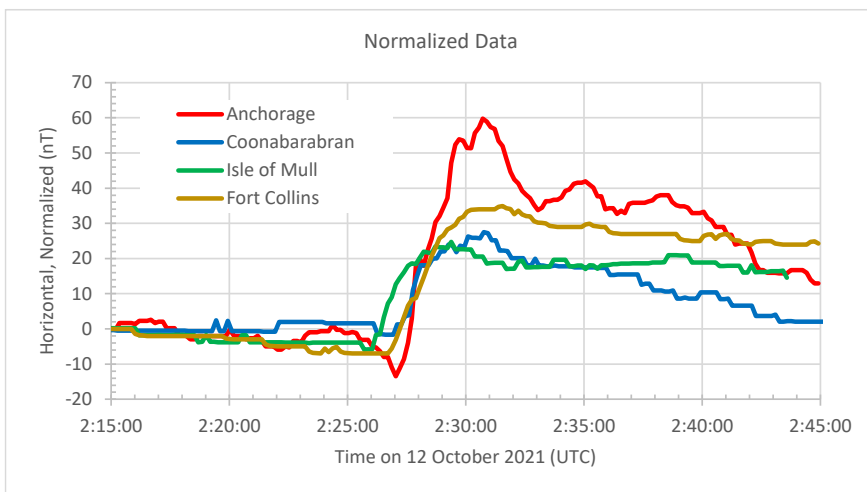

Figure 5 ~ Normalized H-component plots for the four stations. The X and Y data were first converted to H and then normalized to its value at 0215:00. Amplitudes are uncalibrated. Note that all stations recorded an amplitude dip immediately before the sharp increase.

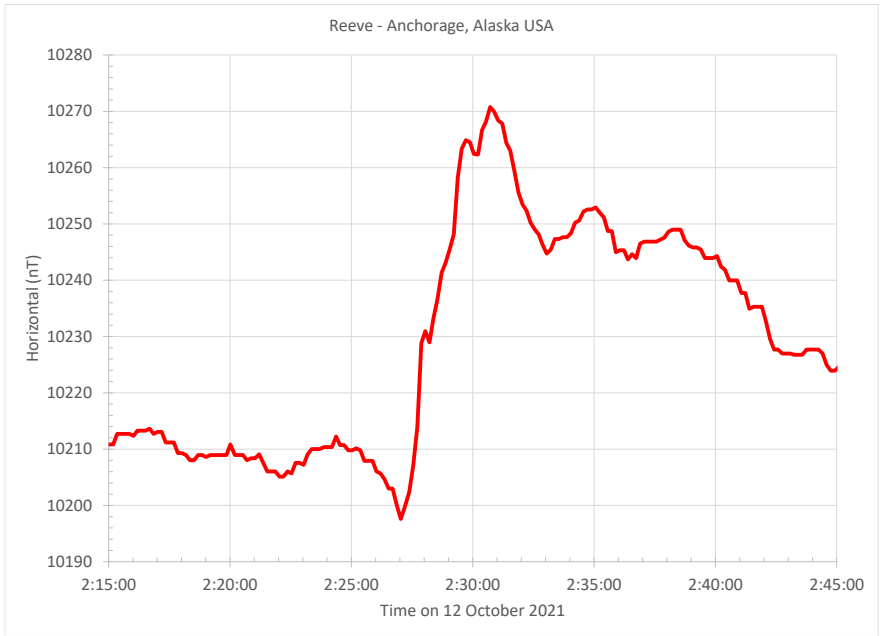

Figure 6.a ~ Raw H-component data plot for Anchorage, Alaska USA. The X and Y data were first converted to H and then normalized to its value at 0215:00. Amplitude is uncalibrated. Solar local time: 16.7 h.

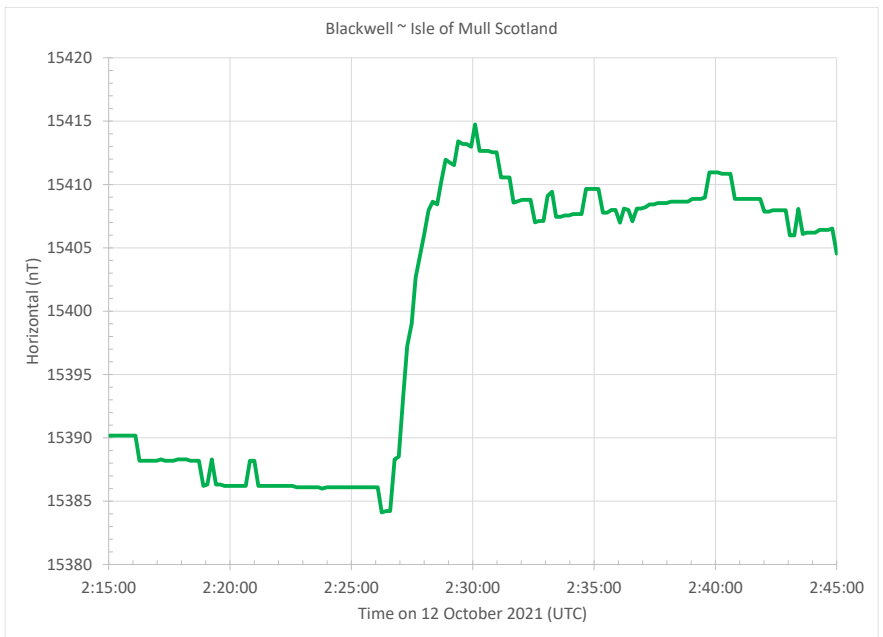

Figure 6.b ~ Raw H-component data plot for Isle of Mull Scotland. The X and Y data were first converted to H and then normalized to its value at 0215:00. Amplitude is uncalibrated. Solar local time: 02.3 h.

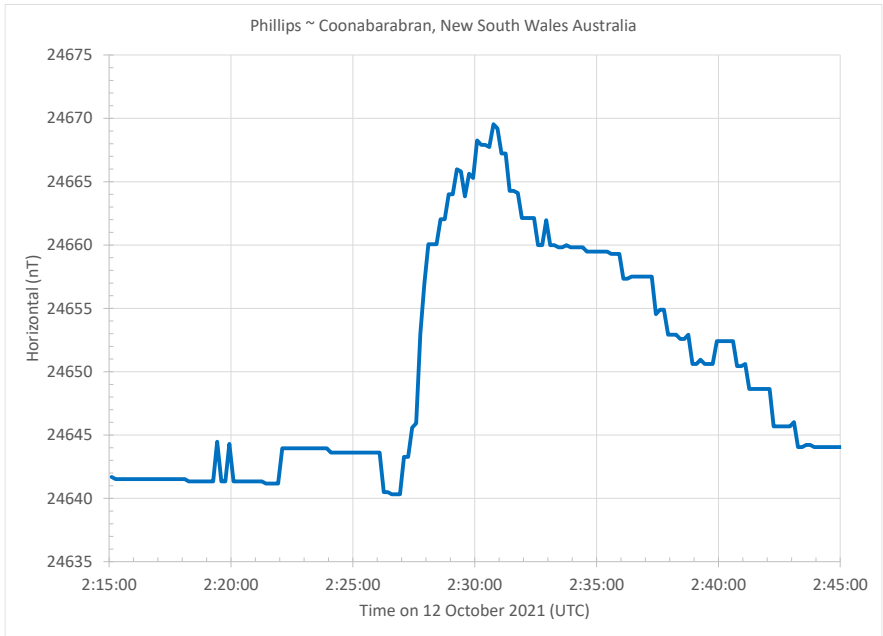

Figure 6.c ~ Raw H-component data plot for Coonabarabran, New South Wales Australia. The X and Y data were first converted to H and then normalized to its value at 0215:00. Amplitude is uncalibrated. Solar local time: 12.7 h. Magnetic local time: 12.7 h.

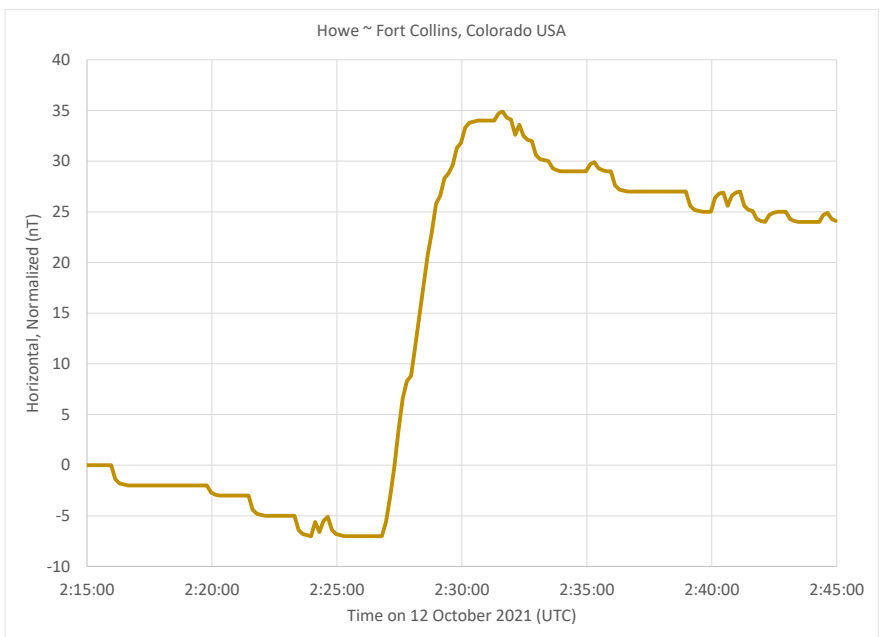

Figure 6.d ~ Normalized raw H-component data plot for Fort Collins, Colorado USA. The X and Y data were first converted to H and then renormalized to its value at 0215:00. Amplitude is uncalibrated. Solar local time: 19.7 h.

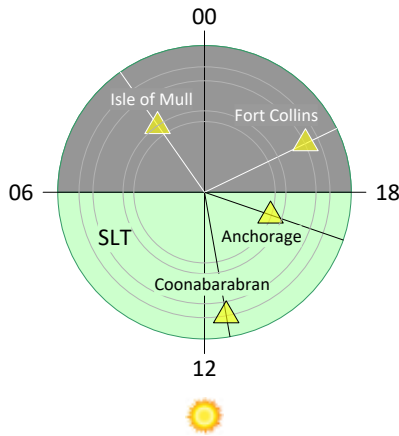

Figure 7 ~ Solar local time at each station when the sudden impulse occurred. SLT is based on the position of the Sun with respect to each station. Solar local noon 1200 is the Sun's transit and solar local midnight is 0000 and directly opposite noon SLT on the Sun-Earth line. This view is looking down on Earth from above the North Pole and shows the stations at their approximate magnetic latitudes.

4. Discussion

The purpose of this section is not to answer the question of simultaneity or propagation but to discuss possible natural effects that could explain the differences in times measured by the four ground magnetometers. The meaning of *almost simultaneously* mentioned in {HGSS21} cannot be answered by analyzing one event measured at four stations. Nevertheless, the sudden impulse event occurred within about 26 s at the four stations located on both the dayside and nightside of Earth. This could be considered *almost simultaneously*. It is noted that the actual time difference between the four stations could be more or less than 26 s because of the 10 s resolution of the SAM-III data.

It is interesting that the station near the midnight side of Earth, Isle of Mull in Scotland, registered the sudden impulse first. The station at Anchorage on the sunset solar terminator registered it last, 26 s after Scotland. A look at {Reeve21}, which compared sudden impulse times measured at Anchorage and Isle of Mull on 12 May 2021, shows that Anchorage detected the sudden impulse 29 s after Scotland, very close to the lag time measured on 12 October.

The estimated CME speed was 600 km s^{-1} when it impacted the magnetosphere (see section 2). At that speed, a 26 s delay implies a travel distance of 15 600 km, or about 2.5 Earth radii. Earth's magnetosphere extends about 8 to 10 Earth radii on the dayside and at least 100 radii on the nightside. However, if propagation delays are involved, the propagation was against the CME direction.

Electric fields exist in the high latitude ionospheres that drive electric currents aligned with the magnetic field lines (*field-aligned currents*). The magnetic field lines at high latitudes are quite steep. Horizontal currents (*Pederson currents*) flow to complete the electric circuit of the field-aligned currents. The electric field also drives another horizontal current system (*Hall current*) that flows across the polar cap from noon to midnight and then from midnight to noon along the auroral oval.

These horizontal current systems concentrate in the auroral oval and comprise the *auroral electrojet* (figure 7). The electrojet has a width of a few hundred kilometers, carries a few million amperes and is located in the evening-midnight-morning sector of the E-region ionosphere in the auroral zone [Reeve10]. It is thought there is only one electrojet but some evidence exists of two, one flowing westward from roughly morning (dawn) to midnight and another flowing eastward from roughly evening (dusk) to midnight. At the time of the CME impact, Isle of Mull was in the midnight region, Anchorage was in the evening (dusk) region, and Coonabarabran was in the noon

region. Fort Collins was nearer to the evening region than the midnight region (see discussion of solar local time in section 3).

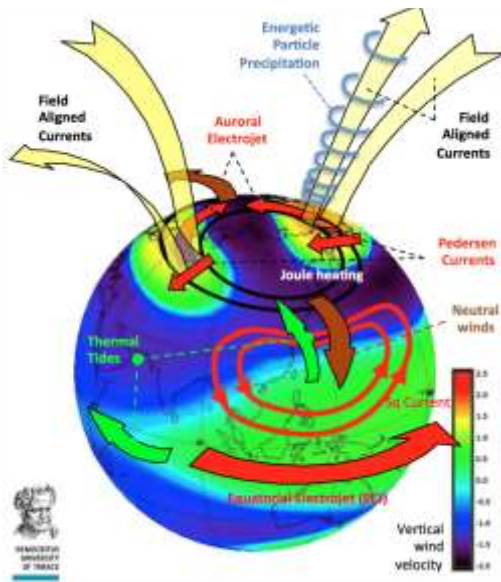

Figure 7 ~ Graphic showing the extreme complexity of the magnetospheric current systems including the auroral and equatorial electrojets and what are thought to be their drivers and interactions. These systems are disturbed by a CME impact and it is unlikely that this disturbance is symmetrical and equal at all ground locations where the SAM-III magnetometers are located. The current systems are weaker or stronger depending on the nightside or dayside and higher or lower latitudes. Image source: Source: {EGU}

As mentioned in section 2, the auroral oval was already expanded on early 12 October due to the enhanced solar wind. Coupling already existed between the magnetosphere and ionosphere at high magnetic latitudes. At the relatively high magnetic latitudes of Isle of Mull and Anchorage, 59° N and 62° N, respectively, the abrupt change in the electrojet current caused by the CME in turn caused an impulse in the magnetic fields in the vicinity of the electrojet. However, the fields and currents usually are not symmetrical around Earth, leading to effects that can vary with location. In this case, there was a delay involved in the effects observed at Anchorage compared to Isle of Mull.

The other two stations, Coonabarabran and Fort Collins, at 38° S and 48° N magnetic latitudes, respectively, are at comparatively lower latitudes and closer to the *equatorial electrojet*. This electrojet is produced by the electric field in the dayside ionosphere and drifts westward as the Sun moves across the sky. The equatorial electrojet is linked to the auroral electrojet by the field-aligned currents mentioned above.

Other situations could exist at the four stations that affect local magnetic measurements. These include remnant magnetism, proximity to the oceans, which have different conductivity than land masses, and underground geologic structures, such magnetic ore bodies, and other near-surface geomagnetic anomalies that distort the local magnetic field. The conductivity and current flows and the induced magnetic fields near Earth's surface are affected by all these characteristics. Rapidly varying ionospheric currents will induce rapidly varying magnetic fields that reinforce or oppose Earth's internal field. However, it is not known how these could affect the timing of abrupt magnetic impulses caused by CMEs.

5. Instrumentation

The SAM-III magnetometer consists of a main controller and three sensors (figure 8). The typical SAM-III generally operates as a variometer in which changes in the magnetic field induction (and not its absolute value) are the important parameters. The four stations in this investigation are set to sample and store the magnetic field measured by each sensor at 10 s intervals (0.1 Hz rate).

The data produced by the SAM-III magnetometers at all stations discussed here are time-stamped by the PCs that collect the data. The real-time clocks in the PCs are synchronized by the Network Time Protocol (NTP) with GNSS-traceable time references. The data are sent from the SAM-III controller to the PC on an asynchronous EIA-232 serial link at 9600 b s^{-1} . Variations in the PCs and their operating systems result in slightly different time stamp sequences. For example, the Anchorage magnetometer produced a data point with a time stamp at 0215:01. The nearest time stamp for the Coonabarabran data was 0214:56 and for the Isle of Mull data was 0215:02, a maximum difference of 6 s. It is believed the time stamps on individual PCs are correct to better than 20 ms of Coordinated Universal Time (UTC).

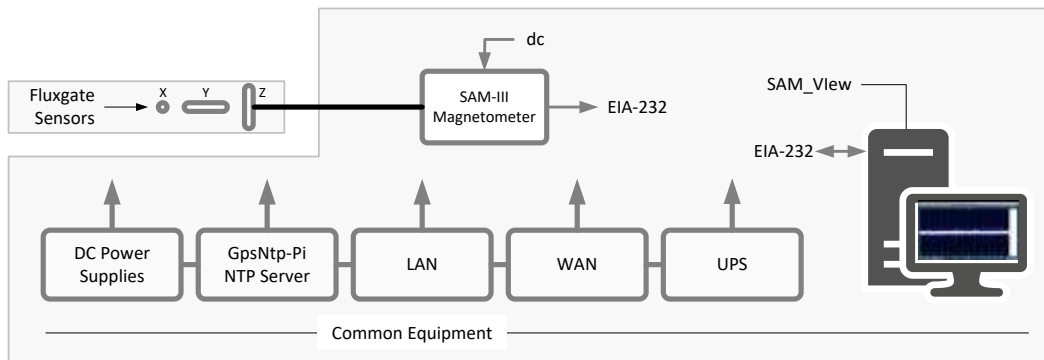

Figure 8 ~ System block diagram for the 3-axis SAM-III station at Anchorage including the common equipment shared across the observatory. The SAM-III sensors are buried about 1 m below the ground surface to reduce temperature effects. Not all stations have the same common equipment. Anchorage, Coonabarabran, and Isle of Mull are configured to measure all three axes, while Fort Collins is configured for two axes, X and Y. Image © 2021 W. Reeve

6. Summary

Magnetic field measurements of the sudden impulse on 12 October 2021 at four widely separated SAM-III magnetometers showed a timing spread 26 s. It is believed that the time stamps at the four stations are accurate to better than 20 ms, but the relatively low data sample rate of 0.1 Hz leads to 10 s resolution of the data. In the context of {HGSS21}, the measurements show the sudden impulse registered at the four locations *almost simultaneously*.

7. Acknowledgements

The author gratefully acknowledges the SAM-III data contributions by Michael Andre Phillips (Coonabarabran, New South Wales, Australia), Roger Blackwell (Isle of Mull, Scotland) and Rodney Howe (Fort Collins, Colorado, USA). The author also is grateful for review comments provided by Doğan Su Öztürk of the University of Alaska Fairbanks – Geophysical Institute.

8. Weblinks & References

- {Aurora} <https://www.gi.alaska.edu/monitors/aurora-forecast>
- {EGU} Sarris, T., et al, Daedalus: a low-flying spacecraft for in situ exploration of the lower thermosphere–ionosphere, *Geoscientific Instrumentation, Methods and Data Systems*, Vol. 9, Iss. 1, 153–191, 2020, doi.org/10.5194/gi-9-153-20202020, available at:
<https://gi.copernicus.org/articles/9/153/2020/gi-9-153-2020-f01-web.png>
- {HGSS21} Sano1, Y. and Nagano, H., Early history of sudden commencement investigation and some newly discovered historical facts, *History of Geo- and Space Sciences*, Vol, 12, Iss. 2, HGSS, 12, 131–162, 2021, available at: <https://hgss.copernicus.org/articles/12/131/2021/>
- {Kyoto} <http://wdc.kugi.kyoto-u.ac.jp/igrf/gggm/index.html>
- {NASA} <https://solarsystem.nasa.gov/missions/DSCOVR/in-depth/>
- [Reeve10] Personal communication with Dr. Syun-Ichi Akasofu, 31 August 2010
- {Reeve13} Reeve, W., *Geomagnetic Sudden Impulses*, 2013, available at:
https://www.reeve.com/Documents/Articles%20Papers/Observations/Reeve_GeomagSuddenImpulses.pdf
- {Reeve21} Reeve, W. and Blackwell, R., Comparative Observations of the 12 May 2021 Geomagnetic Event, 2021, available at: https://www.reeve.com/Documents/Articles%20Papers/Observations/Reeve-Blackwell_CompObrv_12May2021%20GeomagEvt.pdf
- {ReeveWeb} https://www.reeve.com/RadioScience/Radio%20Astronomy%20Publications/Articles_Papers.htm#Geomagnetism_and_SAM-III
- [Rikitake] Rikitake, T., *Electromagnetism and the Earth's Interior*, Elsevier Publishing Company, 1966 (part of the series *Developments in Solid Earth Geophysics*)
- {SWPC-1} ftp://anonymous@ftp.swpc.noaa.gov/pub/forecasts/discussion/10120030forecast_discussion.txt
- {SWPC-2} ftp://anonymous@ftp.swpc.noaa.gov/pub/forecasts/discussion/10130030forecast_discussion.txt
- {WSA-Enlil} <https://www.swpc.noaa.gov/products/wsa-enlil-solar-wind-prediction>

Special Note:

These observation reports are from SARA members and have not been verified by peer review.

These observations are included in the journal to allow for discussion on improving the SARA member's observation system.

Some observations may be **false positives**, therefore the SARA staff requests that recommendations to improve the observation be addressed directly to the author.

Pulsar Observation with a 2.3-m Dish

Wolfgang Herrmann

1. The instrument

The observations reported here were performed with a 2.3-m dish at the Astropfeiler Stockert observatory shown in fig 1. This dish is originally a MIT Haystack SRT [1] which has been fully refurbished, replacing the complete RF chain and the motion control system. The details of this telescope will be described in an article planned for a later edition of the SARA journal. It will cover the refurbishment process and the characteristics of the instrument as well as further observations.



Figure 1: 2.3-m dish used for the observation

2. Setup

The radio frequency (RF) chain was equipped with a passband filter covering the range from 1380 to 1430 MHz. The received signal was down converted to an intermediate frequency (IF) range from 150 to 200 MHz. This IF signal was analysed with the pulsar backend of AstropEiler which has a bandwidth of 100 MHz, ranging from 100 to 200 MHz. Since the RF had a bandwidth of only 50 MHz, part of the backend bandwidth remained unutilized.

3. Observations and data analysis

Observations were performed by tracking the target pulsar B0329+54 and recording the data for several hours. The data was then analysed using a standard software package for pulsar observations, PRESTO. Below in fig. 2 a plot generated by the prepfold command of the PRESTO package is shown.

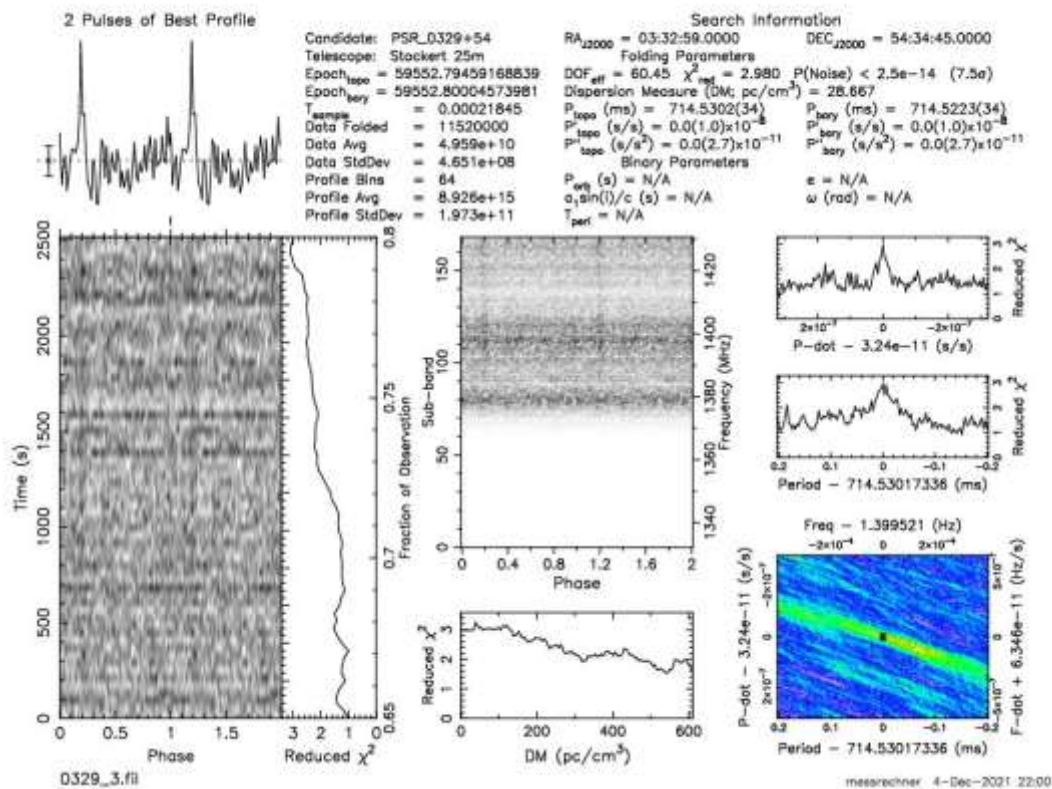

Figure 2: Observation result, PRESTO plot

Please note that the plot says “Stockert 25m”, but the observation was actually done with the 2.3-m dish. This is due to the fact that we are using only one observatory code which the software translates to 25-m dish.

The plot shows only part of the total observation time. It was found that the signal from the pulsar occurred during parts of the observation, but was not visible all the time. This is expected as this pulsar exhibits strong scintillation.

This means that the intensity of the pulsar varies greatly in time and frequency. Therefore, the signal will not be detectable with a small instrument at times, and at other times it becomes visible. Since scintillation can actually increase the intensity temporarily over the long time average, this can make observations possible even if the instrument is not sensitive enough under average conditions.

This type of observation has been repeated several times, and in most cases the pulsar was detected. Fig. 3 shows a second example of such an observation.

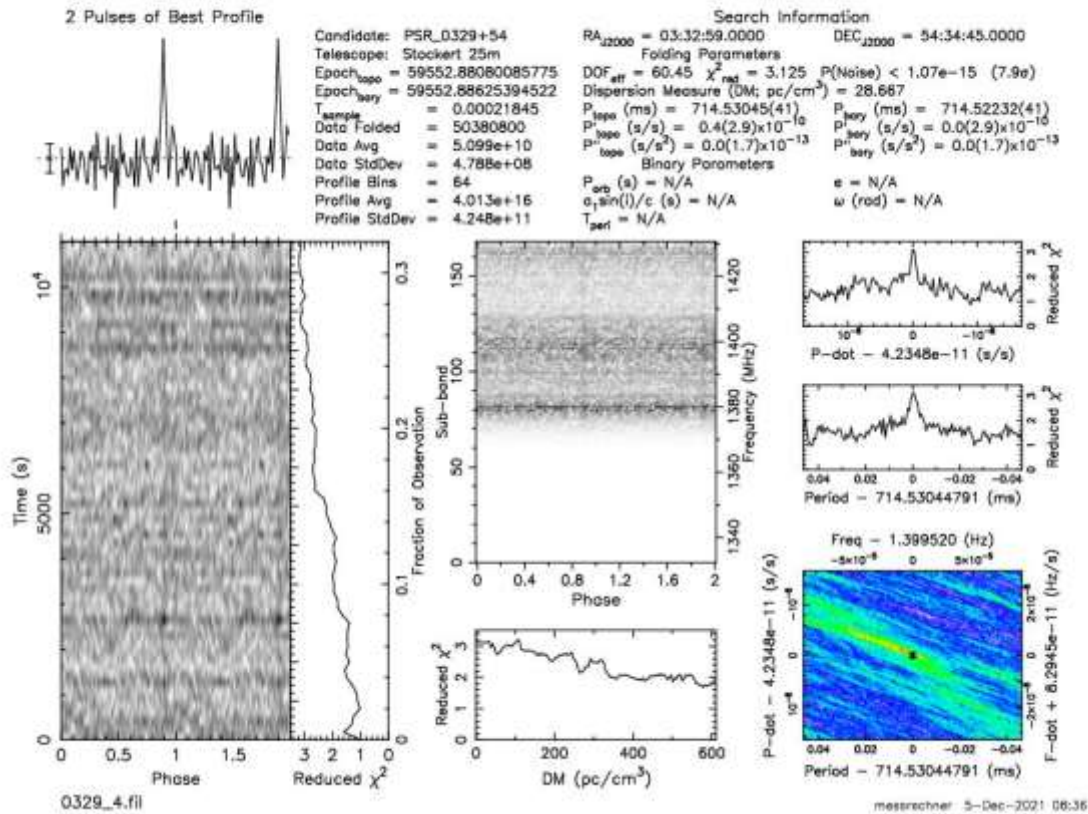

Figure 3: Another observation result, PRESTO plot

4. Discussion and conclusions

As pulsars are weak sources, any observation considered to be successful has to be carefully analysed that the signal is actually from a pulsar. Therefore, a number of tests need to be done – to verify a valid observation. Such tests are described in [2] where we have verified a similar observation with a somewhat larger dish. The tests described there have been applied here as well as a verification.

Observations of the pulsar B0329+54 with small instruments at L-band have been reported in the past by several authors including ourselves with a 3-m dish [2] and further are listed in [3]. The observation described here has been performed with a particularly small aperture, albeit with a relatively high bandwidth. It should be noted that an observation bandwidth in the order of 50 MHz can be achieved also with SDRs such as the Lime SDR. Therefore, we would like to encourage other amateurs with small aperture instruments to give it a try. Remember, scintillation is your friend!

For questions and comments contact the author at messbetrieb@astropeiler.de

References:

- [1] <https://www.haystack.mit.edu/haystack-public-outreach/srt-the-small-radio-telescope-for-education/>
- [2] W. Herrmann, Pulsar observation with a 3-m dish, SARA Journal Sep-Oct 2020
- [3] <https://sites.google.com/view/hawkrao/neutron-star-group/amateur-pulsar-hunters>

Observation of Ionospheric and Magnetic Transients on 27 November 2021

Whitham D. Reeve

Observations: Simultaneous ionospheric and geomagnetic transients were observed on 27 November 2021. The ionospheric transient was recorded at 2251 UTC and the magnetic transient at 2253 UTC. The ionospheric transient was observed as sudden frequency deviations (SFD) at 15, 20 and 25 MHz at Anchorage, Alaska. SFDs normally are caused by strong solar flares but, in this case, the cause was a coronal mass ejection (CME).

The transmitting stations were WWV or WWVH (15 and 20 MHz) and WWV only (25 MHz). The SFD amplitudes increased with frequency. The received signals at 15 and 25 MHz returned to nearly normal about 10 minutes after the disturbance, but 15 MHz, which was weaker than the other two, faded and eventually disappeared as propagation conditions deteriorated after local sunset. The event was recorded on an Argo software narrowband spectrum waterfall plot (figure 1).

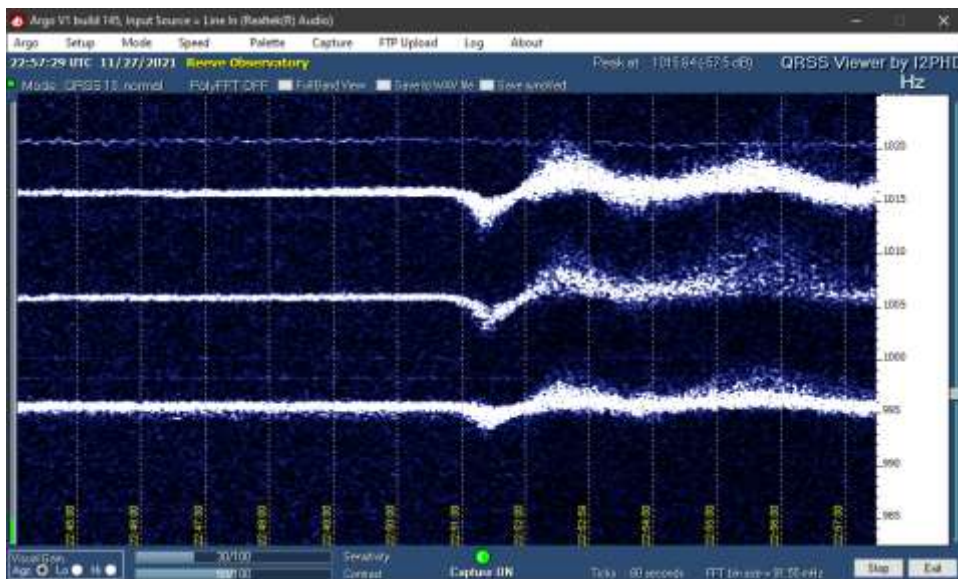

Figure 1 ~ 13-minute plot of demodulated signals for the time period from 2244 to 2257 UTC. The traces correspond to the receiver audio outputs as follows: Lower trace: 15 MHz, receiver tuning 15.000 995 MHz, LSB, carrier demodulated to 995 Hz; Middle trace: 20 MHz, receiver tuning 20.001 005 MHz, LSB, carrier demodulated to 1005 Hz; Upper trace: 25 MHz, receiver tuning 25.001 015 MHz, LSB, carrier demodulated to 1015 Hz.

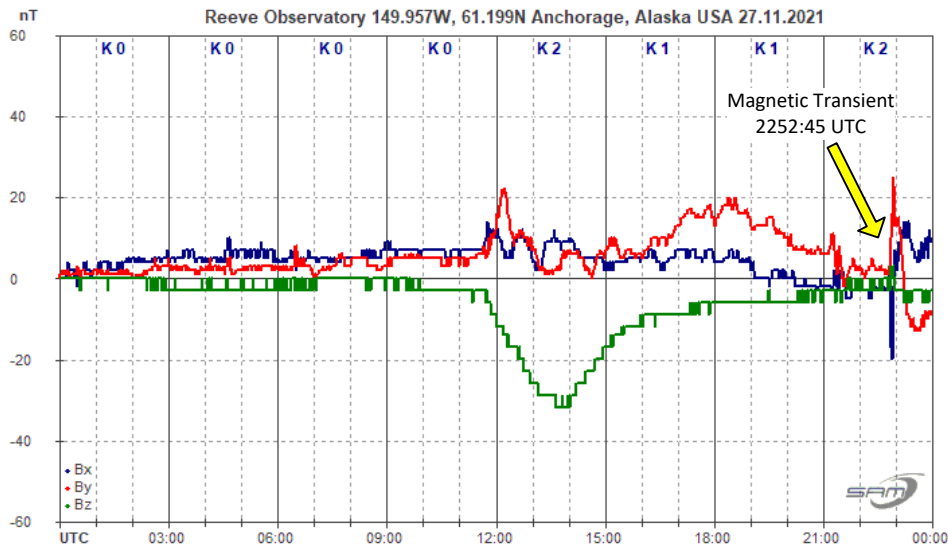

Figure 2 ~ 24-hour SAM_VIEW software plot of the X- (blue trace) , Y- (red trace) and Z- (green trace) magnetic field components for the 24 h period on 27 November. The magnetic field was relatively quiet until the transient at 2252:45 UTC when sharp deflections occurred in the X- and Y-components. These are seen as positive (Y) and negative (X) spikes in the magnetogram. Note that the K-index values throughout the day are low.

A magnetic transient occurred at 2252:45, almost 2 min after the ionospheric transient, in Earth’s magnetic field X- and Y-components. The X-, or north-south, component initially showed a negative deflection and almost immediately reversed to positive relative polarity, while the Y-, or east-west, component went positive and almost immediately reversed to negative relative polarity (figure 2). The deflections were sharp, similar to a sudden impulse, but an SI was not reported by Space Weather Prediction Center (SWPC), possibly because a transient, the precursor to an SI, was not observed at the sentinel spacecraft DSCOVR.

The transients were caused when a CME impacted the geomagnetosphere, compressing it and suddenly altering the current systems flowing in the ionosphere and, in turn, changing the magnetic field measured on the ground. This particular CME originated on 24 November from a filament eruption centered near solar coordinates S36E33. SWPC correctly forecasted the CME arrival late on 27 November.

Instrumentation: See figures 3 and 4.

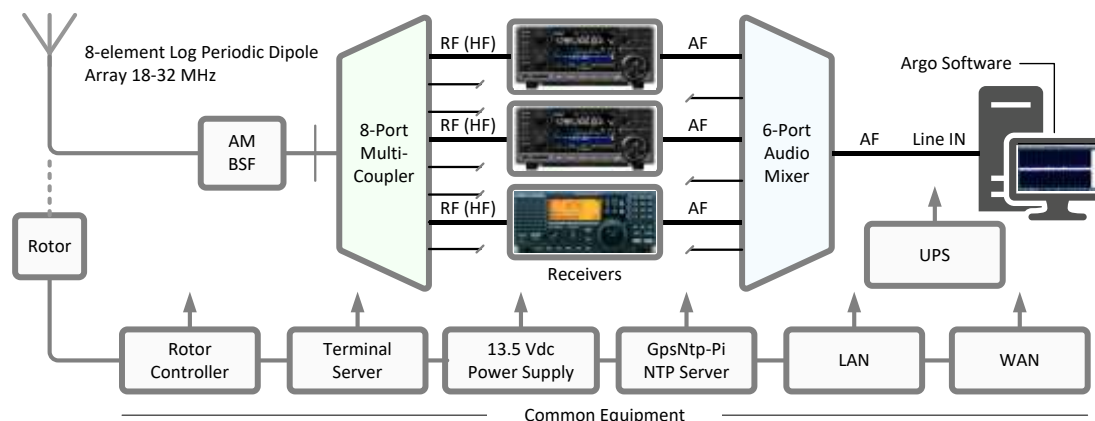

Figure 3 ~ System block diagram for the receiver instrumentation and related common equipment at Anchorage, Alaska. The receivers consisted of two Icom R-8600 wideband receivers and one Icom R-75 general coverage receiver, all set to LSB mode and connected through an audio mixer to the PC soundcard and ultimately demodulated by Argo. The HF log periodic antenna was pointed on a 107° true azimuth toward WWV. Image © 2021 W. Reeve

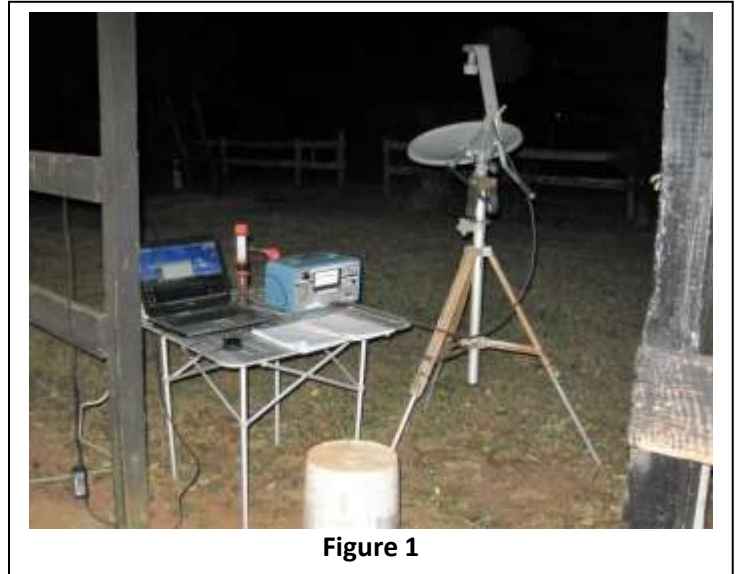

Figure 1

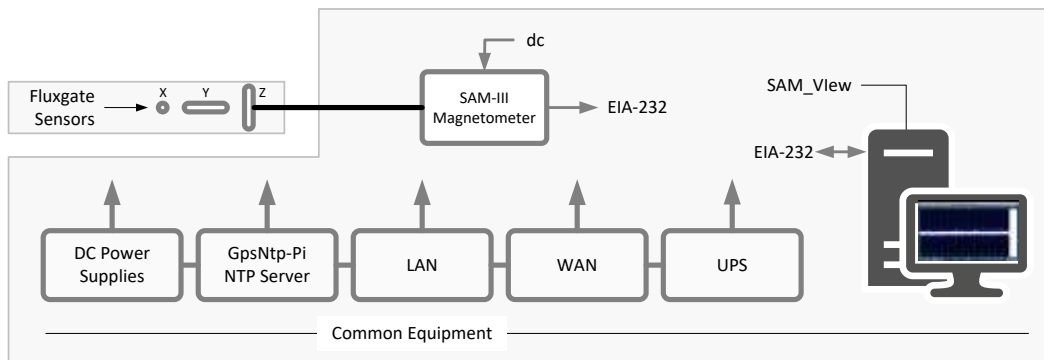

Figure 4 ~ System block diagram of the 3-axis Anchorage SAM-III station including the common equipment shared across the observatory. The SAM-III sensors are buried about 1 m below ground to reduce temperature effects. The sensor outputs are sampled by a multiplexer in the SAM-III controller and sent to the PC on an EIA-232 serial link where the data is displayed and stored by the SAM_VIEW software. Image © 2021 W. Reeve

IBT Observation of the November 2021 Lunar Eclipse

Bruce Randall, NT4RT nt4rt@arrl.net

The lunar eclipse of November 19, 2021 was an opportunity to try some measurements of the moon with my Itty Bitty Telescope (IBT). The IBT [1] is built from an 18" Ku band (12 GHz) satellite dish and LNB. I was not happy with the available satellite finders, so I built my own IBT IF Processor [2] presented at SARA August 2019 conference. An interface to Radio-SkyPipe™ [3] via the USB serial is included. The setup is shown in Figure 1. On the table is the satellite finder in an oversize blue box with a 5" analog meter on the front. All measurements

were recorded with SkyPipe™ and a lap-top computer via the Arduino™ microcomputer board inside the blue box and the Arduino virtual serial port.

Unfortunately, the beginning of the eclipse was missed because of equipment setup problems and starting setup too late. Windows™ decided to change the serial port number and I had to look for the device manager on XP so I could find out where it went. Device Manager is easy to find in later Windows™ versions.

To establish the relative temperature of the moon, two readings were taken. One reading was taken with the IBT carefully aligned on the moon. Optical sights get the IBT close. A variable pitch tone from the satellite finder is peaked to get aimed more accurately on the moon. The second reading is of cold sky. For cold sky the IBT was aimed about 5 degrees off of the moon. The difference between the readings is the relative temperature of the moon. Because I have no way to do an absolute temperature calibration for very small changes, the readings are only relative. Both cold sky and moon readings are altered slightly by a small amount of ground noise (and tree noise) in the antenna sidelobes. **Figure 2** shows the raw data from SkyPipe. There is enough drift in the instrument that a cold sky measurement is needed for each reading.

Figure 3 has offset and slope corrections added to the data. Markers were added for the maximum and end of the eclipse. A second data series was added for moon elevation. The elevation is significant because the end of the eclipse is below the tree line at the Vulture Roost Observatory. **Figure 4** shows point data for when the antenna was moved from the moon to cold sky. Manual checking of the exact UTC Hour of each of these changes and a very messy Excel sheet produced these points. The difference between the moon and cold sky is plotted in **Figure 5**. The readings, although pretty noisy, are clean enough to establish that the 12 GHz radiation from the moon did not change any large amount during the eclipse. It definitely does not track the optical light level.

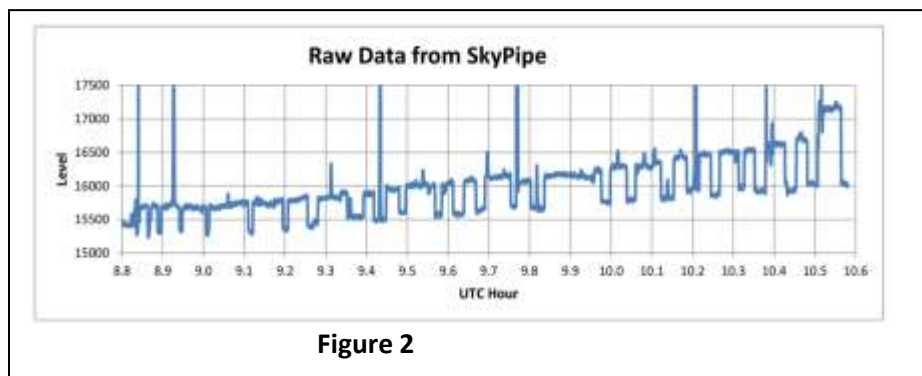

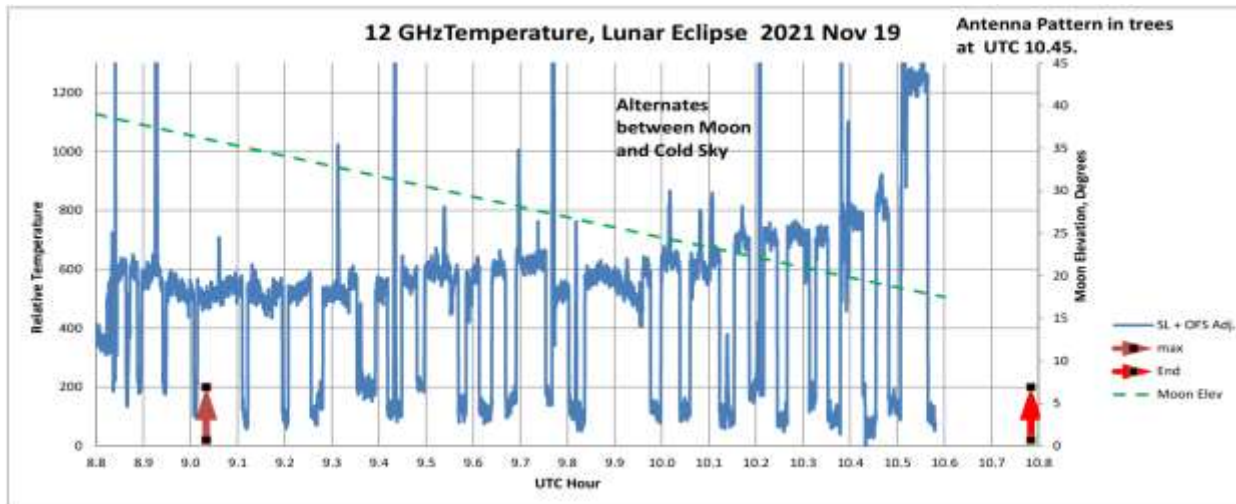

Figure 3

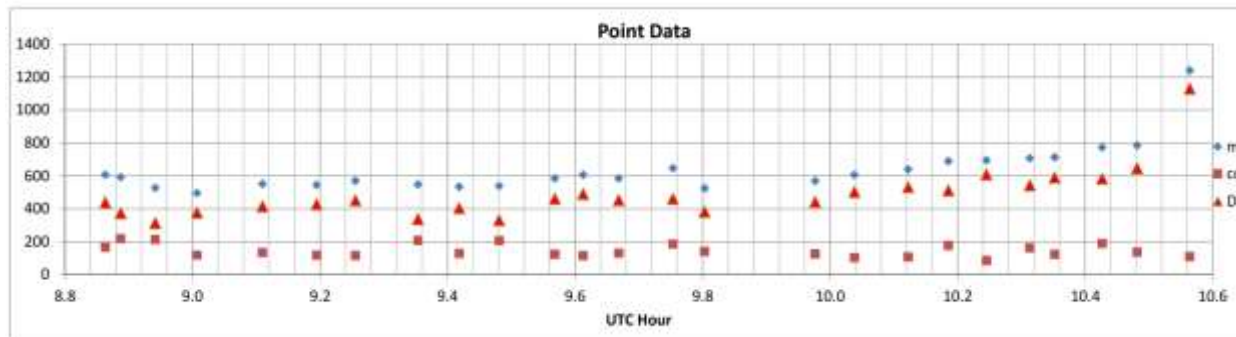

Figure 4

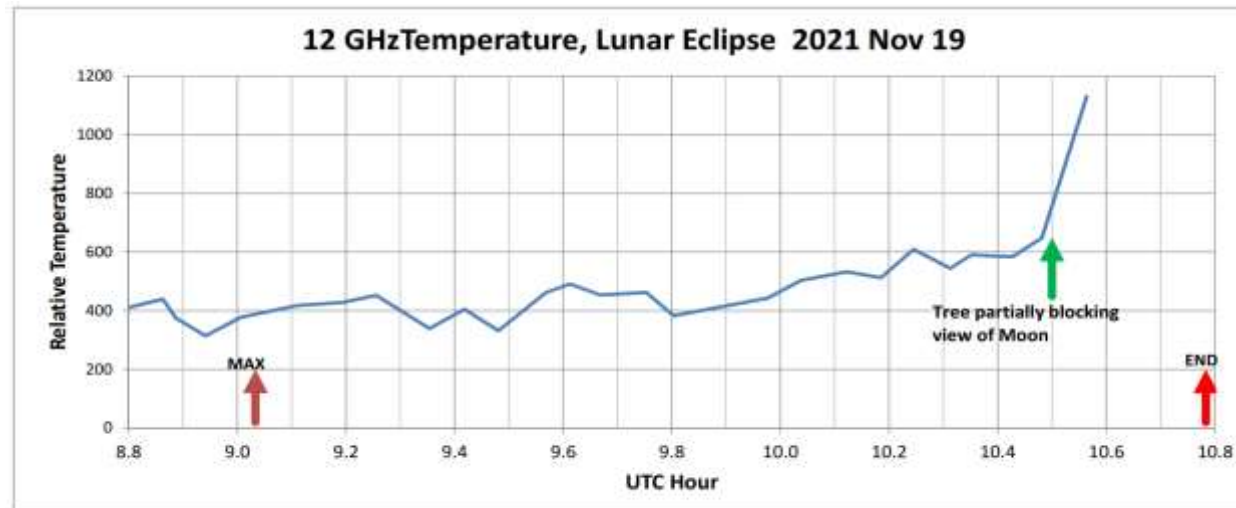

Figure 5

The next question is: “How can better measurements be taken?”

1. More accurate pointing at the moon is needed. Using one of the “Red Dot” reflex sights made for optical telescope to aim at the moon would give much more consistent readings. (One is on order now.)
2. More consistent aiming at the cold sky point is needed. The reflex sight on a star above the moon by 10 degrees or so would do better.
3. Shield the edge of the dish so that less ground noise is observed. **Figure 6** shows a 2019 experiment. The mess of aluminum foil and cardboard lowered the cold sky noise by about 7K. The dish could not be moved without it falling apart. A proper shield ring around the dish of about 10cm width would improve the IBT noise considerably.
4. A timer to remind me when to move the dish from the moon to cold sky and back.
5. A way to inject a low level calibration noise into the receiver. Small probe antennas near the edge of the dish are not consistent. A very small probe near the center of the dish might prove workable.



Figure 6 from 2019 experiment

Notice in **Figure 3** the spikes that often go off scale. Those are interference of some nature. A couple of these spikes were magnified for a closer look. (**Figure 7**) They vary widely in amplitude but are fairly consistent in width at about 7.2 seconds. If it is moving, it cuts through a 3.5° beam. A satellite in Low Earth Orbit would spend at least 50 seconds in the beam. It is apparently not from a satellite.

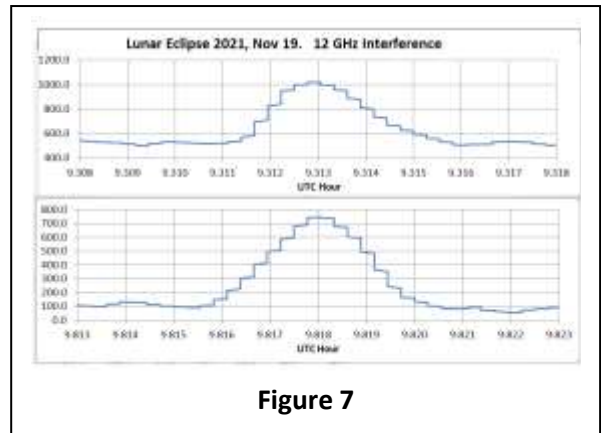
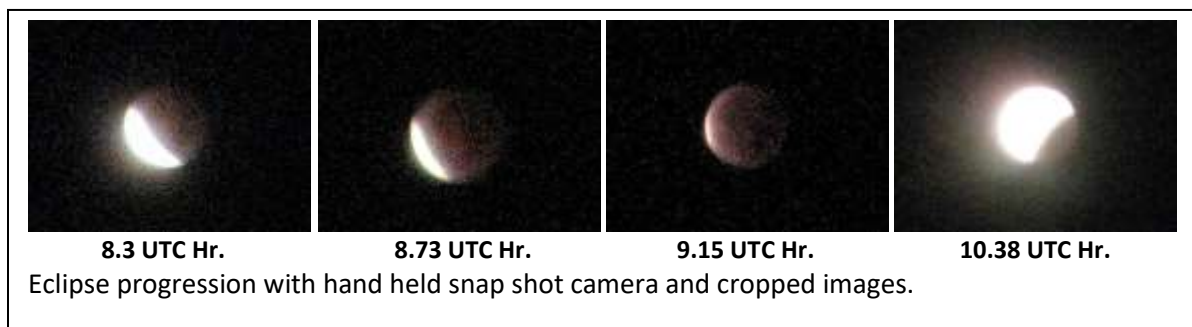

Figure 7

It is fortunate that the moon was separated from the Clark belt by enough to take measurements. The DBS satellites there would have overwhelmed the small temperature rise from the moon.



References:

- [1] IBT information: <http://www.gb.nrao.edu/epo/ambassadors/ibtmanualshort.pdf>
- [2] Bruce Randall, "Arduino Based IBT IF Processor", Proceedings of 2019 SARA conference pp 177-185
- [3] Radio-SkyPipe is available from Radio-Sky Publishing. <http://radiosky.com/skypipeishere.html>



Next chances at total lunar eclipse for North America are May 15, 2022 and November 7, 2022.

About the Author: Bruce is a retired electronic engineer. His work involved analog circuit design, power supplies, solving EMI problems, a bit of DSP work and some antenna design. His hobbies include astronomy, ham radio and radio astronomy. Bruce also enjoys canoeing and hiking, as time permits.

Bruce has been a SARA member for over 30 years. He is now a life member. His experiments with radio astronomy started in 1990, in the days with the chart recorder as the output device. His present interests include interferometers, and possible extended baselines in the future.



Bruce got his first ham radio license in 1966. He presently has an extra class license with a call of NT4RT. (The RT in the call is for "Radio Telescope.")

Bruce has been on the SARA board in the past and is presently SARA's secretary.

An October 2021 Observation of Pulsar B0329+54
Peter East

Pulsar B0329+54 is well-timed for observation in the UK in October, as it culminates around 01.30 UTC - an especially quiet time locally for RFI. The receiver setup is shown in Figure 1. It uses a pair of 2.5m Yagis tuned to the 611MHz RA band, directly feeding a matched pair of 0.4 dB Mini-Circuits amplifiers and combined in a 3 dB in-phase splitter. A 6m low-loss cable feeds two more low-noise amplifiers and a pair of in-line filters driving an Airspy SDR locked to a GPS disciplined oscillator.



Figure 1 Antenna - Receiver Hardware

Data collection is by a laptop PC, it uses a cut-down version of Marcus Leech's superb, belying what he calls his *'stupid simple pulsar'* software, running on GNU Radio. The skeleton version (Figure 2) was used as the intention here was to apply processing algorithms that were developed to mimic the validation functions of the professional software PRESTO, but capable of improved visibility of lower SNR detections. Whilst not its primary function, PRESTO itself, is not robust at validating SNRs much below 10:1.

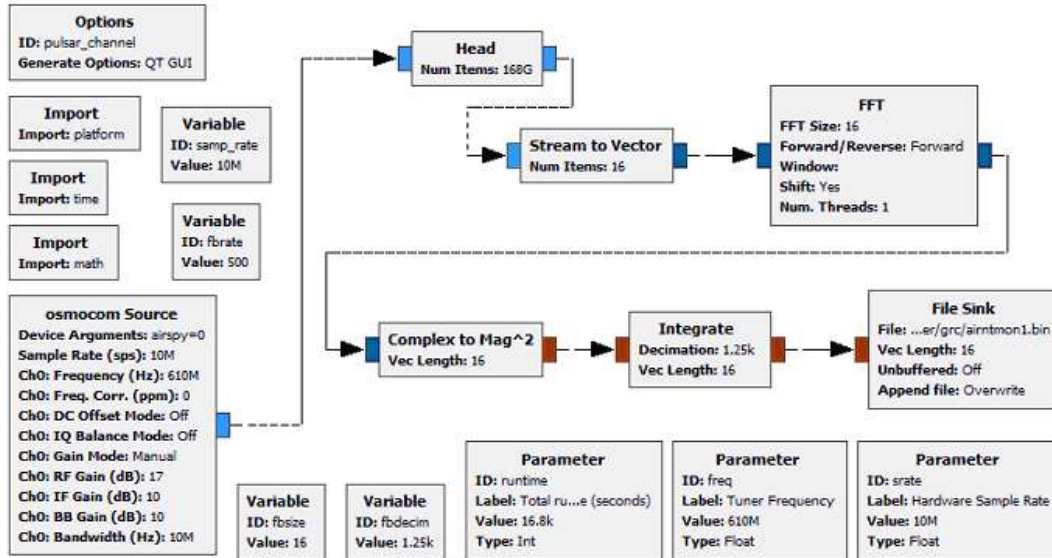

Figure 2 GNU Radio Data Collection Flowgraph

The Figure 2 flow-graph is the set up for collecting 4 hours 40 minutes of data using the 10 MHz bandwidth Airspy SDR tuned to 610 MHz. In operation, the flow-graph reduces some 168 Giga-I/Q data samples down to 16 frequency channel bands totaling 525 MB of 4-byte detected data output. The 'Head' block defines the number of complex data samples processed in the observation. 'Stream to Vector' splits the data into 16 complex streams ready for the 16-bit 'FFT' process. The 16 complex FFT outputs are then converted to 32-bit floating point magnitudes proportional to the input power in the 16 RF bands. The 'Integrate' block sums the data in 1250 sample blocks to downsize the data to 16 x 500 sps rate for recording in the 'File Sink' block. Data was collected over 3 nights, 23, 24 and 25 October; the last was relatively free from interference and is analyzed here. To minimize amplifier drift, the data recording was started an hour before the designated start time and quickly restarted at this time.

With this system, even for 4+ hour pulsar scintillating intercepts of pulsar B0329+54, integrated (folded) data is only expected to produce final signal-to noise ratios of between 3:1 and 7:1. So an amateur-friendly version of the PRESTO processing and validation method was used. This involved compressing and improving the time resolution of the GNU Radio data using a synchronous, partial folding algorithm to reduce the computation load in producing PRESTO-like validation plots. A C-program, *syn_compress.exe* was written to accomplish this data reduction with negligible loss of timing information and no RFI data excision. The compressed file, locked to the TEMPO derived value of the pulsar topocentric period, comprised 16-channels of 142800 samples folded to 0.5 ms resolution and was suitable for RFI blanking and full pulse train analysis. The data for the 25th October 2021 observation produced a 5:1 SNR pulse (Figure 3). MathCad was used for the detailed analysis and for simulating the PRESTO plots, each organized and presented as below. The 16 x RF channels were combined to produce 3-bands to simplify analysis and improve target visibility in the frequency waterfall plot.

The plots together pass all the PRESTO validation criteria.

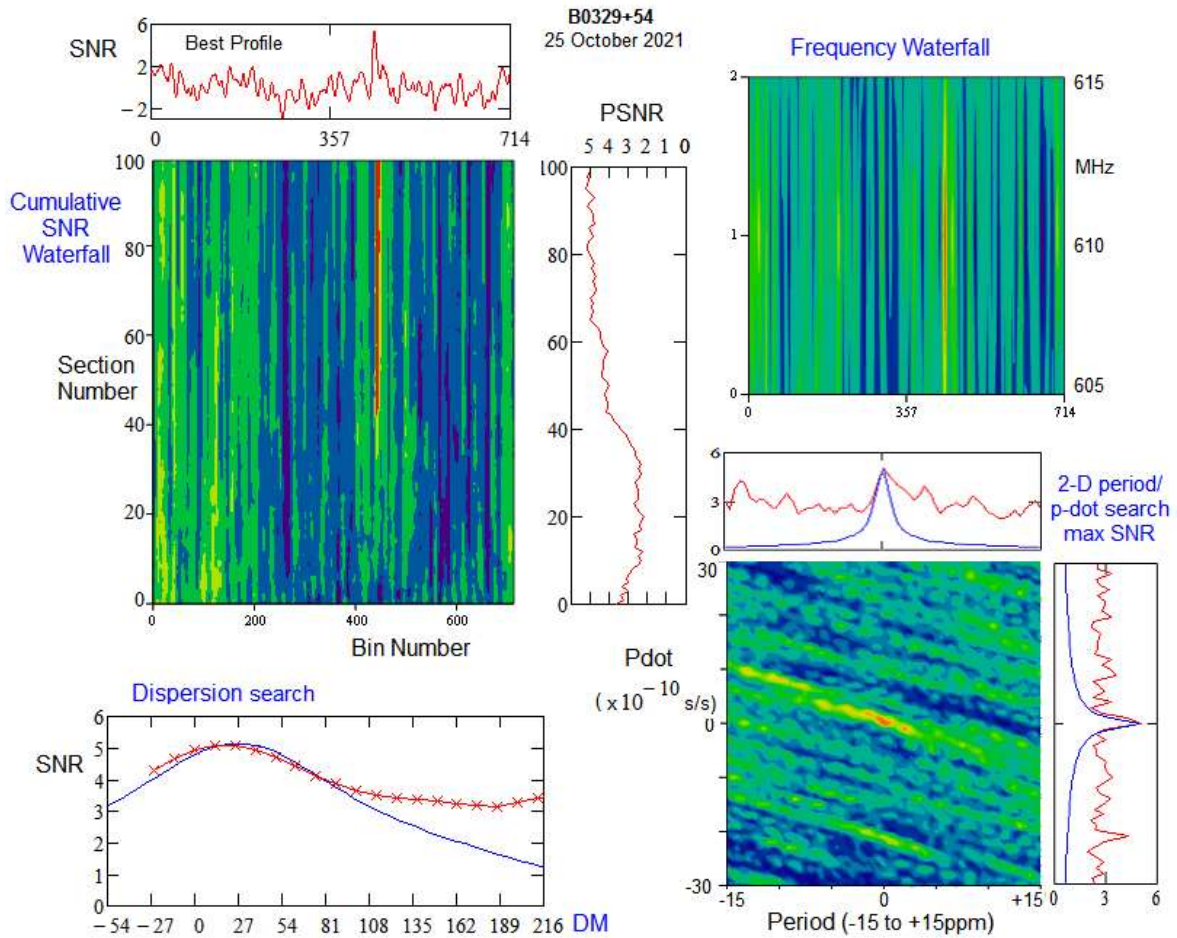

Figure 3 PRESTO-like Validation Plots for 25 October 2021 Observation (red - measured, blue - Gaussian pulse theory).

Note: The background research into processing techniques used for this analysis, has all been published for challenge in SARA Journals. The methods are based on the standard folding algorithm. No data was removed, selected or modified in preparing this article.

PW East November 2021

Membership

New Members

Please welcome our new or returning SARA members who have joined since the last journal. If your name is missing or misspelled, please send an email to treas@radio-astronomy.org. We will make sure it appears correctly in the next Journal issue.

First name	Last name	City	State	Country	Call Sign
James	Bloom	Tiburon	CA	USA	
Robert	Johnson	Williamsfield	IL	USA	
Isaac	Gier	Bellevue	NE	USA	
Maria	Martin	Charlottesville	VA	USA	
Charles	Keller	Lee's Summit	MO	USA	KF0COM
Kevin	Kell	Yarker	Ontario	Canada	
Kevin	Driessen	Amsterdam	Noord-Holland	Netherlands	
Frederick	Moxley	Middleton	Idaho	USA	
Alexis	Rigaud	Lyons		France	
Astrid	Kaczmarzewski	Strasburg	VA	USA	
Russell	Kohrs	Mount Jackson	VA	USA	
James	Waller	Cockatoo Valley		Australia	VK5WJ
Phillip	Hoppes	Phoenix	AZ	USA	

Membership dues are \$20.00 US per year and all dues expire in June. Student memberships are \$5.00 US per year. Memberships must be renewed in June of each year. Or pay once and never worry about missing your dues again with the SARA Life Membership. SARA Life Memberships are now offered for a one-time payment of twenty times the basic annual membership fee (currently \$400 US).

Journal Archives & Other Promotions

The rich and diverse legacy of member contributed content is available in the SARA Journal Archives. Table of contents for journals is available online at radio-astronomy.org/store.

The entire set of The Journal of The Society of Amateur Radio Astronomers is available on USB drive. It goes from the beginning of 1981 to the end of 2017 (over 6000 pages of SARA history!) Or you can choose one of the following USB drive's or DVD:* (Prices are US dollars and include postage.)

†All SARA journals and conference proceedings are available through the previous calendar year.

Prices, US dollars, including postage

Members

Each USB drive	\$15.00
USB drive + 1-year membership extension	\$30.00
Non-members	
Each USB drive	\$25.00
USB drive + 1-year membership	\$30.00
Non-USA members	
Each USB drive	\$20.00 (airmail)
USB drive+ 1-year members extension	\$35.00

*Already a member and want any or all these USB drives or DVD's? Buy any one for \$15.00 or get any three for \$35.00.

SARA Store (radio-astronomy.org/store.)

SARA offers the above USB drives, DVDs, printed Proceedings and Proceedings on USB drive and other items at the SARA Store: <http://www.radio-astronomy.org/e-store>. Proceeds from sales go to support the student grant program. Members receive an additional 10% discount on orders over \$50 US. Payments can be made by sending payment by PayPal to treas@radio-astronomy.org or by mailing a check or money order to SARA, c/o Brian O'Rourke, 337 Meadow Ridge Rd, Troy, VA 22974-3256

SARA Online Discussion Group

SARA members participate in the online forum at <http://groups.google.com/group/sara-list>. This is an invaluable resource for any amateur radio astronomer.

SARA Conferences

SARA organizes multiple conferences each year. Participants give talks, share ideas, attend seminars, and get hands-on experience. For more information, visit <http://www.radio-astronomy.org/meetings>.

Facebook

Like SARA on Facebook

<http://www.facebook.com/pages/Society-of-Amateur-Radio-Astronomers/128085007262843>

Twitter

Follow SARA on Twitter@RadioAstronomy1

What is Radio Astronomy?

This link is for a booklet explaining the basics of radio astronomy.

<http://www.radio-astronomy.org/pdf/sara-beginner-booklet.pdf>

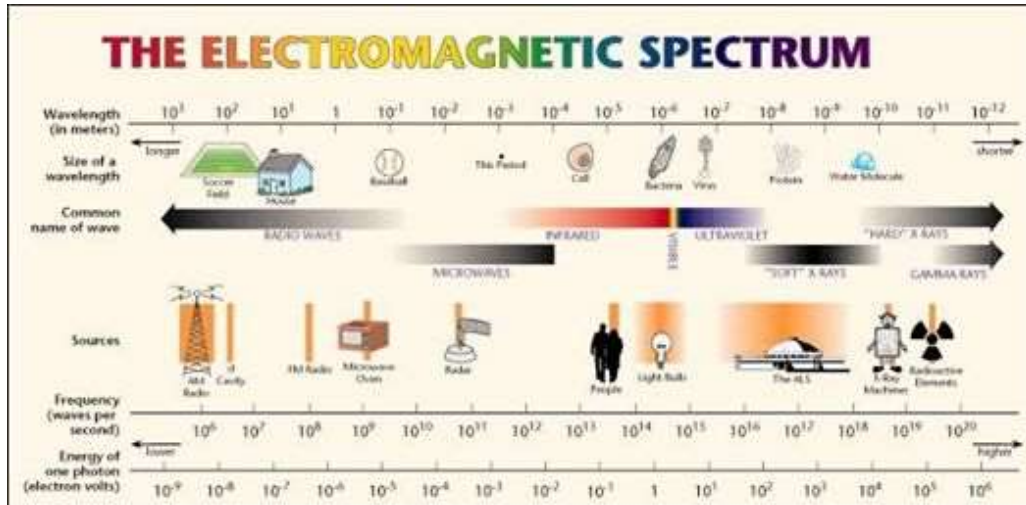

Administrative

Officers, directors, and additional SARA contacts

The Society of Amateur Radio Astronomers is an all-volunteer organization. The best way to reach people on this page is by email with SARA in the subject line SARA Officers.

President: Dennis Farr, WB4RJK, <https://www.radio-astronomy.org/contact/President> +1 813 833-3918

Vice President: Dr. Rich Russel, AC0UB <https://www.radio-astronomy.org/contact/Vicepresident>

Secretary: Bruce Randall, NT4RT, <https://www.radio-astronomy.org/contact/Secretary> +1 803-327-3325

Treasurer: Brian O'Rourke, K4UL, <https://www.radio-astronomy.org/contact/Treasurer>

Past President: Ken Redcap, tbd@radio-astronomy.org +1 319-591-1131

Founder Emeritus and Director: Jeffrey M. Lichtman, K14GIY, jeff@radioastronomysupplies.com +1 954-554-3739

Board of Directors

Name	Term expires	Email
Ed Harfmann	2022	edharfmann@comcast.net
Dr. Wolfgang Herrmann	2023	messbetrieb@astropeiler.de
Tom Jacobs	2023	tj0@bellsouth.net
Charles Osborne	2023	k4cso@twc.com
Keith Payea	2022	kbpayea@bryantlabs.net
Steve Tzikas	2022	Tzikas@alum.rpi.edu
Jon Wallace	2023	wallacefj@comcast.net
David Westman	2022	david.westman@engineeringretirees.org

Other SARA Contacts

All Officers	http://www.radio-astronomy.org/contact-sara
All Directors and Officers	http://www.radio-astronomy.org/contact/All-Directors-and-Officers
Eastern Conference Coordinator	http://www.radio-astronomy.org/contact/Annual-Meeting

All Radio Astronomy Editors	http://www.radio-astronomy.org/contact/Newsletter-Editor	
Radio Astronomy Editor	Dr. Richard A. Russel	drrichrussel@netscape.net
Contributing Editor	Whitham D. Reeve	whitreeve@gmail.com
Educational Outreach	http://www.radio-astronomy.org/contact/Educational-Outreach	
Grant Committee	Tom Crowley	grants@radio-astronomy.org
Membership Chair	http://www.radio-astronomy.org/contact/Membership-Chair	
Technical Queries (David Westman)	http://www.radio-astronomy.org/contact/Technical-Queries	
Webmaster	Ciprian (Chip) Sufitchi, N2YO	webmaster@radio-astronomy.org

Resources

Great Projects to Get Started in Radio Astronomy

Radio Observing Program

The Astronomical League (AL) is starting a radio astronomy observing program. If you observe one category, you get a Bronze certificate. Silver pin is two categories with one being personally built. Gold pin level is at least four categories. (Silver and Gold level require AL membership which many clubs have membership. For the bronze level, you need not be a member of AL.)

Categories include

- 1) SID
- 2) Sun (aka IBT)
- 3) Jupiter (aka Radio Jove)
- 4) Meteor back-scatter
- 5) Galactic radio sources

This program is a collaboration between NRAO and AL. Steve Boerner is the Lead Coordinator and a SARA member.

For more information:

Steve Boerner

2017 Lake Clay Drive

Chesterfield, MO 63017

Email: sboerner@charter.net

Phone: 636-537-2495

<http://www.astroleague.org/programs/radio-astronomy-observing-program>

Radio Jove



The Radio Jove Project monitors the storms of Jupiter, solar activity and the galactic background. The radio telescope can be purchased as a kit or you can order it assembled. They have a terrific user group you can join. <http://radiojove.gsfc.nasa.gov/>

INSPIRE Program



The INSPIRE program uses build-it-yourself radio telescope kits to measure and record VLF emissions such as tweeks, whistlers, sferics, and chorus along with man-made emissions. This is a very portable unit that can be easily transported to remote sites for observations.

<http://theinspireproject.org/default.asp?contentID=27>

SARA/Stanford SuperSID



Stanford Solar Center and the Society of Amateur Radio Astronomers have teamed up to produce and distribute the SuperSID (Sudden Ionospheric Disturbance) monitor. The monitor utilizes a simple pre-amp to magnify the VLF radio signals which are then fed into a high definition sound card. This design allows the user to monitor and record multiple frequencies simultaneously. The unit uses a compact 1-meter loop antenna that can be used indoors or outside. This is an ideal project for the radio astronomer that has limited space. To request a unit, send an e-mail to supersid@radio-astronomy.org

Radio Astronomy Online Resources

AJ4CO Observatory – Radio Astronomy Website: http://www.aj4co.org/	National Radio Astronomy Observatory http://www.nrao.edu
Radio Astronomy calculators https://www.aj4co.org/Calculators/Calculators.html	NRAO Essential Radio Astronomy Course http://www.cv.nrao.edu/course/astr534/ERA.shtml
Introduction to Amateur Radio Astronomy (presentation) http://www.aj4co.org/Publications/Intro%20to%20Amateur%20Radio%20Astronomy,%20Typinski%20(AAC,%202016)%20v2.pdf	Exotic Ions and Molecules in Interstellar Space -- ORION 2020 10 21. Dr. Bob Compton https://www.youtube.com/watch?v=r6cKhp23SUo&t=5s
RF Associates Richard Flagg, rf@hawaii.rr.com 1721-1 Young Street, Honolulu, HI 96826	The Radio JOVE Project & NASA Citizen Science – ORION 2020.6.17. Dr. Chuck Higgins https://www.youtube.com/watch?v=s6eWAXjywp8&t=5s
RFSpace, Inc. http://www.rfspace.com	UK Radio Astronomy Association http://www.ukraa.com/
CALLISTO Receiver & e-CALLISTO http://www.reeve.com/Solar/e-CALLISTO/e-callisto.htm	CALLISTO software and data archive: www.e-callisto.org
Deep Space Exploration Society http://DSES.science	Radio Astronomy Supplies http://www.radioastronomysupplies.com
Deep Space Object Astrophotography Part 1 -- ORION 2021 02 17. George Sradnov https://www.youtube.com/watch?v=Pm_Rs17KIyQ	Radio Jove Spectrograph Users Group http://www.radiojove.org/SUG/
European Radio Astronomy Club http://www.era.net	Radio Sky Publishing http://radiosky.com
British Astronomical Association – Radio Astronomy Group http://www.britastro.org/baa/	The Arecibo Radio Telescope; It's History, Collapse, and Future - ORION 2020.12.16. Dr. Stan Kurtz, Dr. David Fields https://www.youtube.com/watch?v=rBZIPOLNX9E
Forum and Discussion Group http://groups.google.com/group/sara-list	Shirleys Bay Radio Astronomy Consortium marcus@propulsionpolymers.com
GNU Radio https://www.gnuradio.org/	SARA Twitter feed https://twitter.com/RadioAstronomy1
SETI League http://www.setileague.org	SARA Web Site http://radio-astronomy.org
NRAO Essential Radio Astronomy Course http://www.cv.nrao.edu/course/astr534/ERA.shtml	SARA Facebook page https://www.facebook.com/pages/Society-of-Amateur-Radio-Astronomers/128085007262843
NASA Radio JOVE Project http://radiojove.gsfc.nasa.gov Archive: http://radiojove.org/archive.html	Simple Aurora Monitor: Magnetometer http://www.reeve.com/SAMDescription.htm
National Radio Astronomy Observatory http://www.nrao.edu	Stanford Solar Center http://solar-center.stanford.edu/SID/
A New Radio Telescope for Mexico - ORION 2021 01 20. Dr. Stan Kurtz https://www.youtube.com/watch?v=Q9aBWr1aBVc	

For Sale, Trade and Wanted

At the SARA online store: radio-astronomy.org/store.

SARA Polo Shirts

New SARA shirts have arrived.

We now have a good selection of X, XX, and XXX shirts available in all colors including white! Shirts are \$20 at the conference and \$25 shipped.

Contact the treasurer at treas@radio-astronomy.org for availability and shipping.



Scope in a Box \$295

radio-astronomy.org/store.

Kit of parts and software to build a working Radio Telescope to detect Hydrogen Line emissions. Available to USA addresses only at this time.

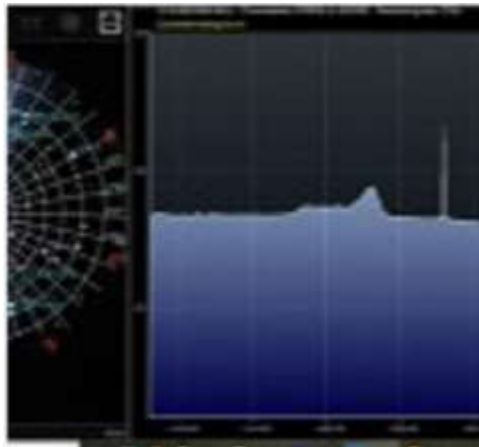

SuperSID Complete Kit (\$112-\$160 depending on options)

radio-astronomy.org/store.



SARA Publication, Journals and Conference Proceedings (various prices)

radio-astronomy.org/store.

SARA Journal USB Drive (\$15-\$35 depending on shipping option)

radio-astronomy.org/store.

The USB drive covers the society journal "Radio Astronomy" from the founding of the organization in 1981 thru 2020. Articles cover a wide range of topics including: cosmic radiation, pulsars, quasars, meteor detection, solar observing, Jupiter, Radio Jove, gamma ray bursts, the Itty Bitty Telescope (IBT), dark matter, black holes, the Jansky antenna, methanol masers, mapping at 408 MHz and more. This CD contains all of the above and more with over 4800 pages of articles on radio astronomy. Also included is a copy of Grote Reber's handwritten, 34 page document "Carriage and Mirror Detail" of his historic antenna now on display at the National Radio Astronomy Observatory (NRAO) in Green bank, WV. You also get an electronic copy of the 109 page "Basics of Radio Astronomy" from JPL Goldstone-Apple Valley Radio Telescope. Also included is the NRAO 40-foot radio telescope "Operators Manual", which by the way, you get to operate if you attend the Eastern SARA conference in July.

SARA Advertisements

There is no charge to place an ad in Radio Astronomy; but you must be a current SARA member. Ads must be pertinent to radio astronomy and are subject to the editor's approval and alteration for brevity. Please send your "For Sale," "Trade," or "Wanted" ads to edit@radio-astronomy.org. Please include email and/or telephone contact information. Please keep your ad text to a reasonable length. Ads run for one bimonthly issue unless you request otherwise.

Radio-Astro-Machine, zlblac@gmail.com

Elevation rotation adapter plate for Scope in a Box and custom machining. For further information visit <https://radio-astro-machine.wixsite.com/my-site> or send an email.

Typinski Radio Astronomy, Inc., info@typinski.com

Antenna systems and feed line components for HF radio astronomy

Jeff Kruth, WA3ZKR, kmec@aol.com

RF components from HF to MMW, various types including mixers, RF switches, amplifiers, oscillators, coaxial components, waveguide components, etc. I have a very large collection of stuff and the facilities to test and provide data. Please email with your needs and I will see if I have something for you. Have fun!

Stuart and Lorraine Rumley, sales@valontechnology.com

The Valon Technology 2100 Downconverter, when combined with our 5009 frequency synthesizer module, provides a high-performance, compact receiver downconverter system. Applications include hydrogen line studies at 1420MHz and radio astronomy in the protected 30MHz segment of the 21 cm band. For more information visit <http://www.valontechnology.com/2100downconverter.html> or send an email.

Radio2Space, filippo.bradaschia@primalucelab.com

SPIDER radio telescopes and turn-key-systems designed specifically for education.

<https://www.radio2space.com>

We developed our SPIDER radio telescopes as turn-key-system just to avoid the problem you perfectly highlighted in your website: "Purchasing a radio telescope isn't like buying an optical telescope. They are harder to find, and usually require assembly and software troubleshooting. In some cases, a radio telescope must be built from components." Our SPIDER radio telescopes are not designed for amateurs that prefer to build a radio telescope but to schools, universities, museums, and other science institutes that needs for a complete and ready-to-use system, just like the optical telescopes they can normally buy!

Radio Astronomy Supplies

<http://www.radioastronomysupplies.com>

jeff@radioastronomysupplies.com

Research and Educational Radio Telescopes and all associated equipment since 1994

Membership Information

Annual SARA dues Individual \$20, Classroom \$20, Student \$5 (US funds) anywhere in the world. Membership includes a subscription to Radio Astronomy, the bimonthly Journal of The Society of Amateur Radio Astronomers, delivered electronically (via a secure web link, emailed to you as each new issue is posted). We regret that printing and postage costs prevent SARA from providing hardcopy subscriptions to our Journal.

We would appreciate the following information included with your check or money order, made payable to SARA:

Name: _____
 Email Address: _____
(required for electronic Journal delivery)
 Ham call sign: _____ (if applicable)
 Address: _____
 City: _____
 State: _____
 Zip: _____
 Country: _____
 Phone: _____

Please include a note of your interests. Send your application for membership, along with your remittance, to our Treasurer.

For further information, see our website at: <http://radio-astronomy.org/membership>



How to get started?

SARA has a made a kit of software and parts to detect the Hydrogen line signal from space. This is an excellent method to get started in radio astronomy. It teaches the principles of antenna design, signal detection, and signal processing. Read more about this and other projects on our web site.

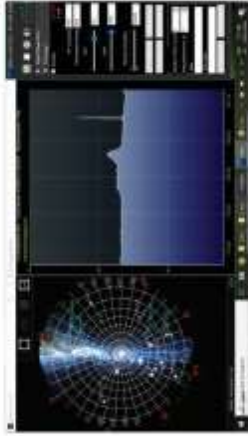

Membership supported, nonprofit [501(c) (3)]
 Educational and Radio Astronomy Organization
**Knowledge through Common Research,
 Education and Mentoring**



SARA members have been privileged to use this forty foot diameter drift-scan hydrogen line radio telescope every year at their annual meeting in Green Bank.

Why Radio Astronomy?

Because about sixty five percent of our current knowledge of the universe has stemmed from radio astronomy alone. The discovery of quasars, pulsars, black holes, the 3K background from the "Big Bang" and the discovery of biochemical hydrogen/carbon molecules are all the result of professional radio astronomy.



<http://radio-astronomy.org>



The Society of Amateur Radio Astronomers

SARA was founded in 1981, with the purpose of educating those interested in pursuing amateur radio astronomy.

The society is open to all, wishing to participate with others, worldwide.

SARA members have many interests, some are as follows:

SARA Areas of Study and Research:

- Solar Radio Astronomy
- Galactic Radio Astronomy
- Meteor Detection
- Jupiter
- SETI
- Gamma Ray/High Energy Pulse Detection
- Antennas
- Design of Hardware / Software

The members of the society offer a friendly mentor atmosphere. All questions and inquiries are answered in a constructive manner. No question is silly!

SARA offers its members an electronic bi-monthly journal entitled Radio Astronomy. Within the journal, members report on their research and observations. In addition, members receive updates on the professional radio astronomy community and, society news.

Once a year SARA meets for a three-day conference at the Green Bank Observatory in Green Bank West Va.

There is also a spring conference held at various cities in the Western USA. Previous meetings have been at the VLA in Socorro, NM and at Stanford University.



How do amateurs do radio astronomy?

Radio astronomy by amateurs is conducted using antennas of various shapes and sizes, from smaller parabolic dishes to simple wire antennas. These antennas are connected to receivers and most of these receivers are software defined radios these days. Data from the receivers are collected by computers, and the received signals will be displayed as charts, graphs or maybe even sky maps. As diverse as the observed objects, so is the instruments and tools used. SARA members will always be supportive to find good solutions for what one wishes to observe.

Is amateur radio astronomy instrumentation expensive?

Technical information freely circulated in our monthly journal helps amateurs to obtain good low noise equipment from off the shelf assemblies, or to build their own units. The actual cash investment in radio astronomy equipment need not exceed that of any other hobby.

What are amateurs actually looking for in the received data?

The aim of the radio amateur is to find something new and unusual. Just as an amateur optical observer hopes to notice a supernova or a new comet, so does an amateur radio observer hope to notice a new radio source, or one whose radiation has changed appreciably.

How do I get started?

Just as a long journey begins with the first step, the project you elect must start with a clear idea of your objectives. Do you wish to study the sun? Jupiter? Make meteor counts? Do you wish to engage in imaging radio astronomy? What you decide will not only determine the type of equipment you will need, but also the local radio spectrum.



The Reber Telescope at NRAO. Constructed by Grote Reber in 1937 in his back yard in Wheaton, Illinois



SARA Members discussing the IBT (Itty Bitty Telescope)

